

# Thyristor Modules

## Thyristor/Diode Modules

$$I_{TRMS} = 2 \times 300 \text{ A}$$

$$I_{TAVM} = 2 \times 190 \text{ A}$$

$$V_{RRM} = 800\text{-}1800 \text{ V}$$

$V_{RSM}$	$V_{RRM}$	Type	
$V_{DSM}$	$V_{DRM}$		
V	V	Version 1	Version 1
900	800	MCC 162-08io1	MCD 162-08io1
1300	1200	MCC 162-12io1	MCD 162-12io1
1500	1400	MCC 162-14io1	MCD 162-14io1
1700	1600	MCC 162-16io1	MCD 162-16io1
1900	1800	MCC 162-18io1	MCD 162-18io1

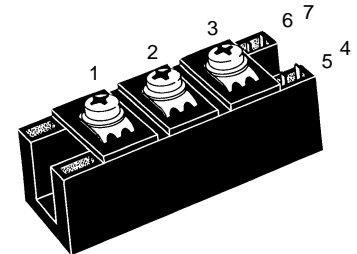

Symbol	Test Conditions	Maximum Ratings	
$I_{TRMS}, I_{FRMS}$ $I_{TAVM}, I_{FAVM}$	$T_{VJ} = T_{VJM}$ $T_C = 80^\circ\text{C}; 180^\circ \text{ sine}$ $T_C = 85^\circ\text{C}; 180^\circ \text{ sine}$	300 190 181	A A A
$I_{TSM}, I_{FSM}$	$T_{VJ} = 45^\circ\text{C};$ $V_R = 0$	$t = 10 \text{ ms (50 Hz), sine}$ $t = 8.3 \text{ ms (60 Hz), sine}$	6000 6400 A A
	$T_{VJ} = T_{VJM}$ $V_R = 0$	$t = 10 \text{ ms (50 Hz), sine}$ $t = 8.3 \text{ ms (60 Hz), sine}$	5250 5600 A A
$\int i^2 dt$	$T_{VJ} = 45^\circ\text{C}$ $V_R = 0$	$t = 10 \text{ ms (50 Hz), sine}$ $t = 8.3 \text{ ms (60 Hz), sine}$	180 000 170 000 $\text{A}^2\text{s}$ $\text{A}^2\text{s}$
	$T_{VJ} = T_{VJM}$ $V_R = 0$	$t = 10 \text{ ms (50 Hz), sine}$ $t = 8.3 \text{ ms (60 Hz), sine}$	137 000 128 000 $\text{A}^2\text{s}$ $\text{A}^2\text{s}$
$(di/dt)_{cr}$	$T_{VJ} = T_{VJM}$ $f = 50 \text{ Hz}, t_p = 200 \mu\text{s}$ $V_D = 2/3 V_{DRM}$ $I_G = 0.5 \text{ A}$ $dI_G/dt = 0.5 \text{ A}/\mu\text{s}$	repetitive, $I_T = 500 \text{ A}$  non repetitive, $I_T = 500 \text{ A}$	150  500 $\text{A}/\mu\text{s}$
$(dv/dt)_{cr}$	$T_{VJ} = T_{VJM}$ $R_{GK} = \infty$ ; method 1 (linear voltage rise)	$V_{DR} = 2/3 V_{DRM}$	1000 $\text{V}/\mu\text{s}$
$P_{GM}$	$T_{VJ} = T_{VJM}$ $I_T = I_{TAVM}$	$t_p = 30 \mu\text{s}$ $t_p = 500 \mu\text{s}$	120 60 8 W W
$P_{GAV}$			8 W
$V_{RGM}$			10 V
$T_{VJ}$			-40...+125 $^\circ\text{C}$
$T_{VJM}$			125 $^\circ\text{C}$
$T_{stg}$			-40...+125 $^\circ\text{C}$
$V_{ISOL}$	50/60 Hz, RMS $I_{ISOL} \leq 1 \text{ mA}$	$t = 1 \text{ min}$ $t = 1 \text{ s}$	3000 3600 V~ V~
$M_d$	Mounting torque (M6) Terminal connection torque (M6)		2.25-2.75/20-25 4.5-5.5/40-48 Nm/lb.in. Nm/lb.in.
Weight	Typical including screws		125 g

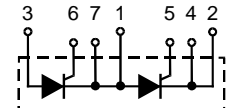
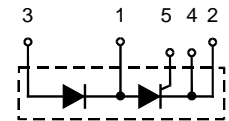
**MCC**

**MCD**

**Features**

- International standard package
- Direct copper bonded  $\text{Al}_2\text{O}_3$  -ceramic base plate
- Planar passivated chips
- Isolation voltage 3600 V~
- UL registered, E 72873
- Keyed gate/cathode twin pins

**Applications**

- Motor control
- Power converter
- Heat and temperature control for industrial furnaces and chemical processes
- Lighting control
- Contactless switches

**Advantages**

- Space and weight savings
- Simple mounting
- Improved temperature and power cycling
- Reduced protection circuits

Data according to IEC 60747 and refer to a single thyristor/diode unless otherwise stated.  
IXYS reserves the right to change limits, test conditions and dimensions

Symbol	Test Conditions	Characteristic Values
$I_{RRM}, I_{DRM}$	$T_{VJ} = T_{VJM}; V_R = V_{RRM}; V_D = V_{DRM}$	10 mA
$V_T, V_F$	$I_T, I_F = 300 \text{ A}; T_{VJ} = 25^\circ\text{C}$	1.25 V
$V_{TO}$	For power-loss calculations only ( $T_{VJ} = 125^\circ\text{C}$ )	0.88 V
$r_T$		1.15 mΩ
$V_{GT}$	$V_D = 6 \text{ V}; T_{VJ} = 25^\circ\text{C}$	2.5 V
	$T_{VJ} = -40^\circ\text{C}$	2.6 V
$I_{GT}$	$V_D = 6 \text{ V}; T_{VJ} = 25^\circ\text{C}$	150 mA
	$T_{VJ} = -40^\circ\text{C}$	200 mA
$V_{GD}$	$T_{VJ} = T_{VJM}; V_D = 2/3 V_{DRM}$	0.2 V
$I_{GD}$		10 mA
$I_L$	$T_{VJ} = 25^\circ\text{C}; t_p = 30 \mu\text{s}; V_D = 6 \text{ V}$ $I_G = 0.5 \text{ A}; di_G/dt = 0.5 \text{ A}/\mu\text{s}$	300 mA
$I_H$	$T_{VJ} = 25^\circ\text{C}; V_D = 6 \text{ V}; R_{GK} = \infty$	200 mA
$t_{gd}$	$T_{VJ} = 25^\circ\text{C}; V_D = 1/2 V_{DRM}$ $I_G = 0.5 \text{ A}; di_G/dt = 0.5 \text{ A}/\mu\text{s}$	2 μs
$t_q$	$T_{VJ} = T_{VJM}; I_T = 300 \text{ A}, t_p = 200 \mu\text{s}; -di/dt = 10 \text{ A}/\mu\text{s}$ typ. $V_R = 100 \text{ V}; dv/dt = 20 \text{ V}/\mu\text{s}; V_D = 2/3 V_{DRM}$	150 μs
$Q_S$	$T_{VJ} = T_{VJM}; I_T, I_F = 300 \text{ A}, -di/dt = 50 \text{ A}/\mu\text{s}$	550 μC
$I_{RM}$		235 A
$R_{thJC}$	per thyristor/diode; DC current	0.155 K/W
$R_{thJK}$	per thyristor/diode; DC current	0.0775 K/W
	per thyristor/diode; DC current	0.225 K/W
	per module	0.1125 K/W
$d_s$	Creepage distance on surface	12.7 mm
$d_A$	Strike distance through air	9.6 mm
$a$	Maximum allowable acceleration	50 m/s <sup>2</sup>

Optional accessories for modules

Keyed gate/cathode twin plugs with wire length = 350 mm, gate = yellow, cathode = red

Type **ZY 180L** (L = Left for pin pair 4/5) } UL 758, style 1385,

Type **ZY 180R** (R = right for pin pair 6/7) } CSA class 5851, guide 460-1-1

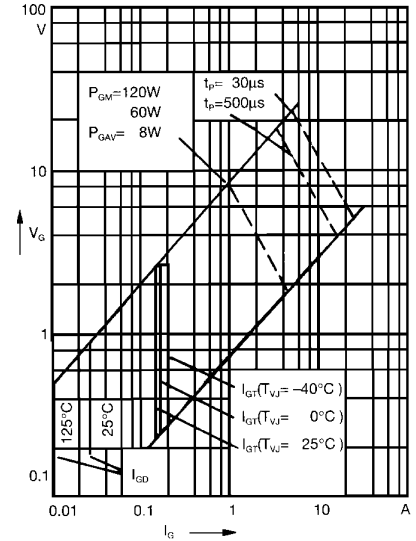

Fig. 1 Gate trigger characteristics

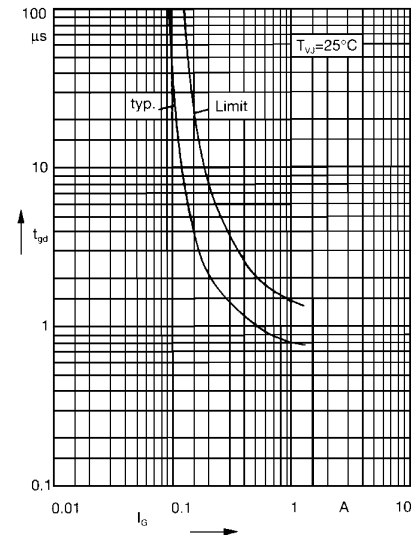
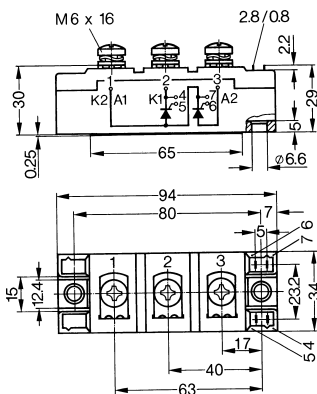

Fig. 2 Gate trigger delay time

### Dimensions in mm (1 mm = 0.0394")

#### MCC Version 1



#### MCD Version 1

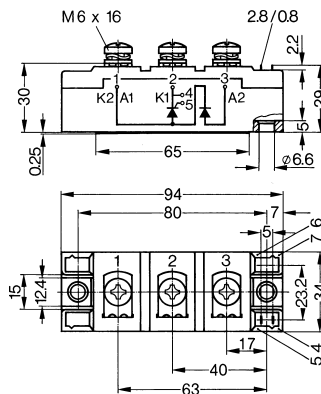

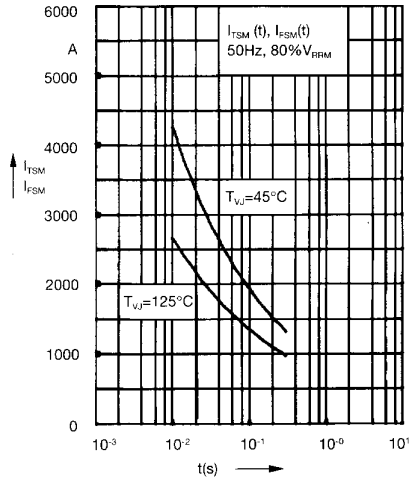

Fig. 3 Surge overload current  
 $I_{TSM}, I_{FSM}$ : Crest value,  $t$ : duration

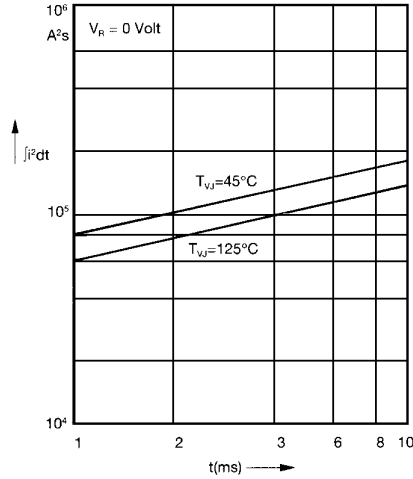

Fig. 4  $\int j^2 dt$  versus time (1-10 ms)

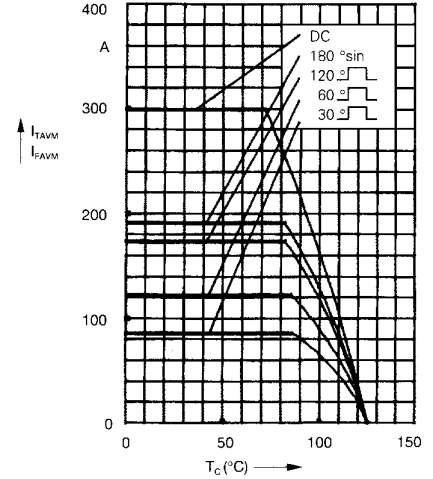

Fig. 4a Maximum forward current at case temperature

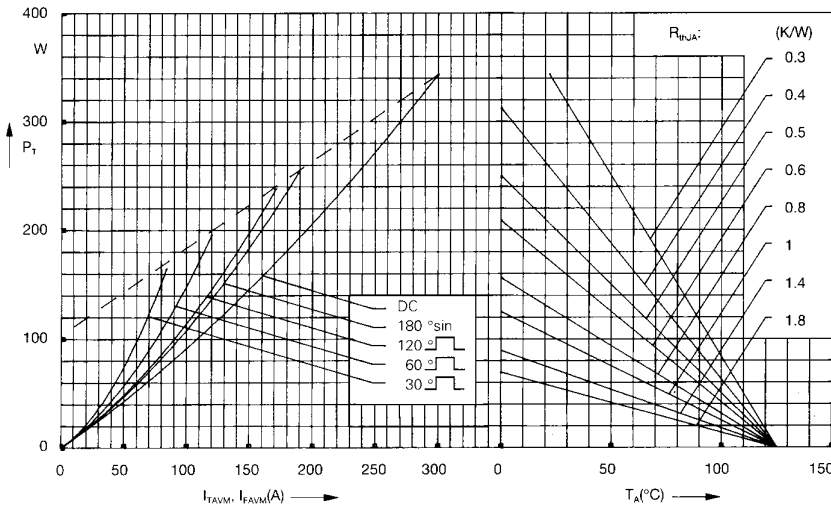

Fig. 5 Power dissipation versus on-state current and ambient temperature (per thyristor or diode)

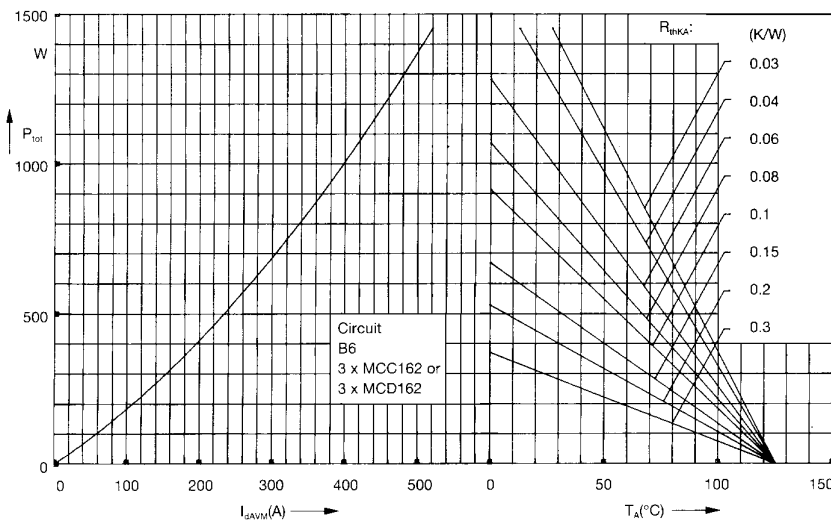

Fig. 6 Three phase rectifier bridge: Power dissipation versus direct output current and ambient temperature

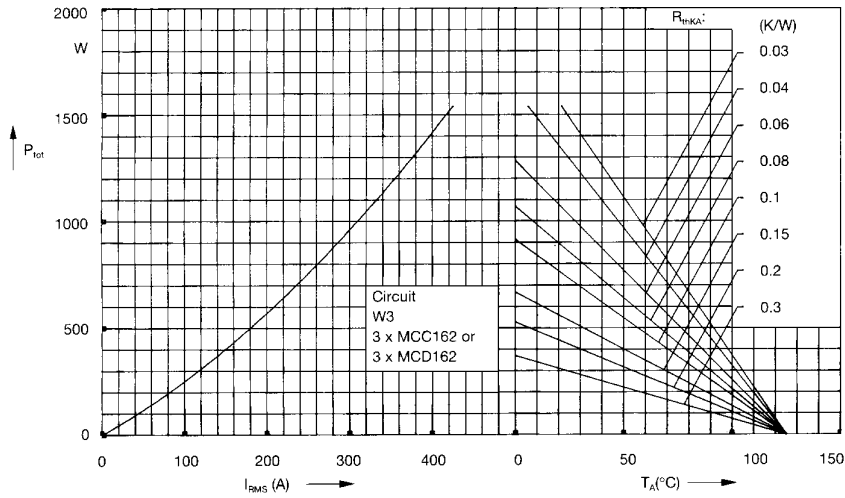

Fig. 7 Three phase AC-controller:  
Power dissipation versus RMS  
output current and ambient  
temperature

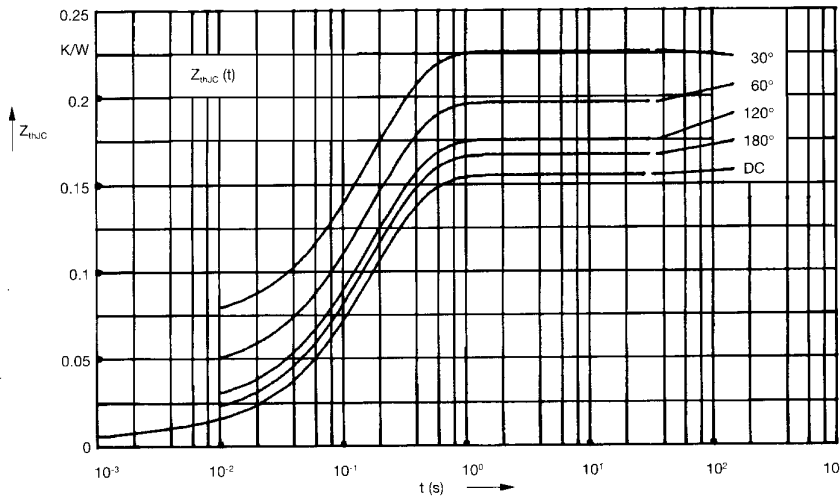

Fig. 8 Transient thermal impedance  
junction to case (per thyristor or  
diode)

$R_{thJC}$  for various conduction angles  $d$ :

$d$	$R_{thJC}$ (K/W)
DC	0.155
180°	0.167
120°	0.176
60°	0.197
30°	0.227

Constants for  $Z_{thJC}$  calculation:

$i$	$R_{thi}$ (K/W)	$t_i$ (s)
1	0.0072	0.001
2	0.0188	0.08
3	0.129	0.2

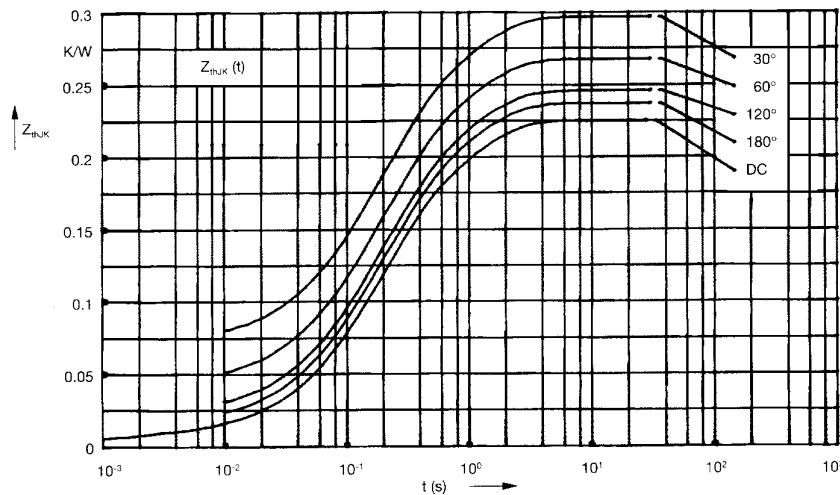

Fig. 9 Transient thermal impedance  
junction to heatsink (per thyristor  
or diode)

$R_{thJK}$  for various conduction angles  $d$ :

$d$	$R_{thJK}$ (K/W)
DC	0.225
180°	0.237
120°	0.246
60°	0.267
30°	0.297

Constants for  $Z_{thJK}$  calculation:

$i$	$R_{thi}$ (K/W)	$t_i$ (s)
1	0.0072	0.001
2	0.0188	0.08
3	0.129	0.2
4	0.07	1.0