

$V_{RSM}$	$V_{RRM}$	(dv/dt) <sub>cr</sub>	$I_{TRMS}$ (maximum value for continuous operation)			
	$V_{DRM}$		150 A			
V	V	V/μs	$I_{TAV}$ (sin. 180; T <sub>case</sub> = 85°C)			
			95 A			
500	400	500	–	–	SKKH 91/04 D	–
700	600	500	SKKT 91/06 D	SKKT 92/06 D	SKKH 91/06 D	SKKH 92/06 D
900	800	500	SKKT 91/08 D	SKKT 92/08 D	SKKH 91/08 D	SKKH 92/08 D
1300	1200	1000	SKKT 91/12 E	SKKT 92/12 E <sup>1)</sup>	SKKH 91/12 E	SKKH 92/12 E
1500	1400	1000	SKKT 91/14 E	SKKT 92/14 E <sup>1)</sup>	SKKH 91/14 E	SKKH 92/14 E
1700	1600	1000	SKKT 91/16 E	SKKT 92/16 E <sup>1)</sup>	SKKH 91/16 E	SKKH 92/16 E
1900	1800	1000	SKKT 91/18 E	SKKT 92/18 E <sup>1)</sup>	SKKH 91/18 E	SKKH 92/18 E

## SEMI<sup>®</sup>PACK 1 Thyristor / Diode Modules

SKKT 91      SKKH 91  
SKKT 92      SKKH 92  
SKKT 92B     SKMT 92<sup>2)</sup>  
SKKL 92<sup>2)</sup>

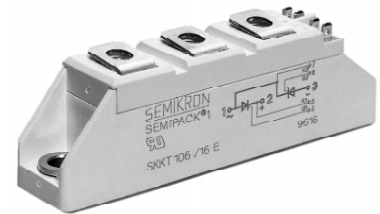

Symbol	Conditions	SKKT 91 SKKH 91	SKKT 92 SKKT 92B SKKH 92	Units
$I_{TAV}$	sin. 180; T <sub>case</sub> = 85°C	95		A
$I_D$	B2/B6 T <sub>amb</sub> = 45 °C; P 3/180	70 / 85		A
	T <sub>amb</sub> = 35 °C; P 3/180 F	140 / 175		A
$I_{RMS}$	W1/W3 T <sub>amb</sub> = 35 °C; P 3/180 F	190 / 3 x 135		A
$I_{TSM}$	T <sub>vj</sub> = 25 °C; 10 ms	2 000		A
	T <sub>vj</sub> = 125 °C; 10 ms	1 750		A
$i^2t$	T <sub>vj</sub> = 25 °C; 8,3 ... 10 ms	20 000		A <sup>2</sup> s
	T <sub>vj</sub> = 125 °C; 8,3 ... 10 ms	15 000		A <sup>2</sup> s
$t_{gd}$	T <sub>vj</sub> = 25 °C; I <sub>G</sub> = 1 A;			
	di <sub>G</sub> /dt = 1 A/μs	1		μs
$t_{gr}$	V <sub>D</sub> = 0,67 · V <sub>DRM</sub>	2		μs
(di/dt) <sub>cr</sub>	T <sub>vj</sub> = 125 °C	150		A/μs
$t_q$	T <sub>vj</sub> = 125 °C	typ. 100		μs
$I_H$	T <sub>vj</sub> = 25 °C; max.	250		mA
$I_L$	T <sub>vj</sub> = 25 °C; R <sub>G</sub> = 33 Ω; max.	600		mA
$V_T$	T <sub>vj</sub> = 25 °C; I <sub>T</sub> = 300 A	max. 1,65		V
$V_{T(TO)}$	T <sub>vj</sub> = 125 °C	0,9		V
$r_T$	T <sub>vj</sub> = 125 °C	2		mΩ
$I_{DD}; I_{RD}$	T <sub>vj</sub> = 125 °C; V <sub>RD</sub> = V <sub>RRM</sub> V <sub>DD</sub> = V <sub>DRM</sub>	max. 20		mA
$V_{GT}$	T <sub>vj</sub> = 25 °C; d.c.	3		V
$I_{GT}$	T <sub>vj</sub> = 25 °C; d.c.	150		mA
$V_{GD}$	T <sub>vj</sub> = 125 °C; d.c.	0,25		V
$I_{GD}$	T <sub>vj</sub> = 125 °C; d.c.	6		mA
$R_{thjc}$	cont. } per thyristor / sin. 180 } per module rec. 120 }	0,28 / 0,14		°C/W
		0,30 / 0,15		°C/W
		0,32 / 0,16		°C/W
$R_{thch}$		0,2 / 0,1		°C/W
$T_{vj}$		– 40 ... + 125		°C
$T_{stg}$		– 40 ... + 125		°C
$V_{isol}$	a. c. 50 Hz; r.m.s.; 1 s/1 min	3600 / 3000		V~
$M_1$	to heatsink } SI (US) units	5 (44 lb. in.) ± 15 % <sup>3)</sup>		Nm
$M_2$	to terminals }	3 (26 lb. in.) ± 15 %		Nm
$a$		5 · 9,81		m/s <sup>2</sup>
$w$	approx.	95		g
Case	→ page B 1 – 95	SKKT 91: A 5	SKKL 92: A 59	
		SKKH 91: A 6	SKKT 92: A 46	
		SKMT 92: A 72	SKKT 92B: A 48	
		SKKH 92: A 47		

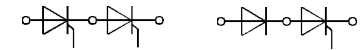

SKKT 91

SKKH 91



SKKT 92  
SKKT 92B

SKKH 92

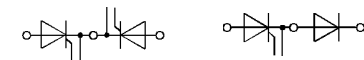

SKMT 92

SKKL 92

### Features

- Heat transfer through aluminium oxide ceramic isolated metal baseplate
- Hard soldered joints for high reliability
- UL recognized, file no. E 63 532

### Typical Applications

- DC motor control (e.g. for machine tools)
- AC motor soft starters
- Temperature control (e.g. for ovens, chemical processes)
- Professional light dimming (studios, theaters)

<sup>1)</sup> Also available in SKKT 92B configuration (case A 48)

<sup>2)</sup> SKKL 92, SKMT 92 available on request

<sup>3)</sup> See the assembly instructions

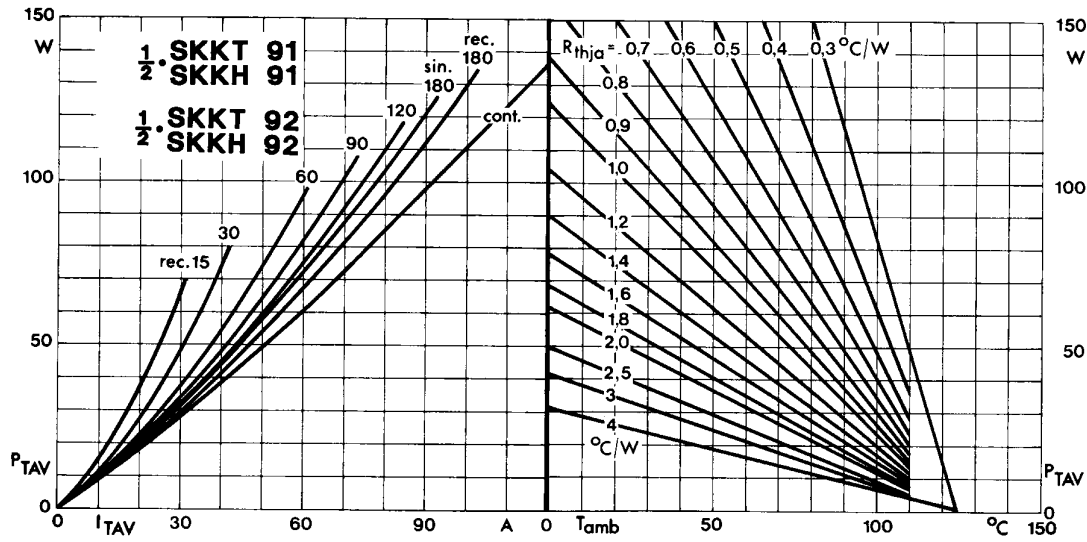

Fig. 1 Power dissipation per thyristor vs. on-state current and ambient temperature

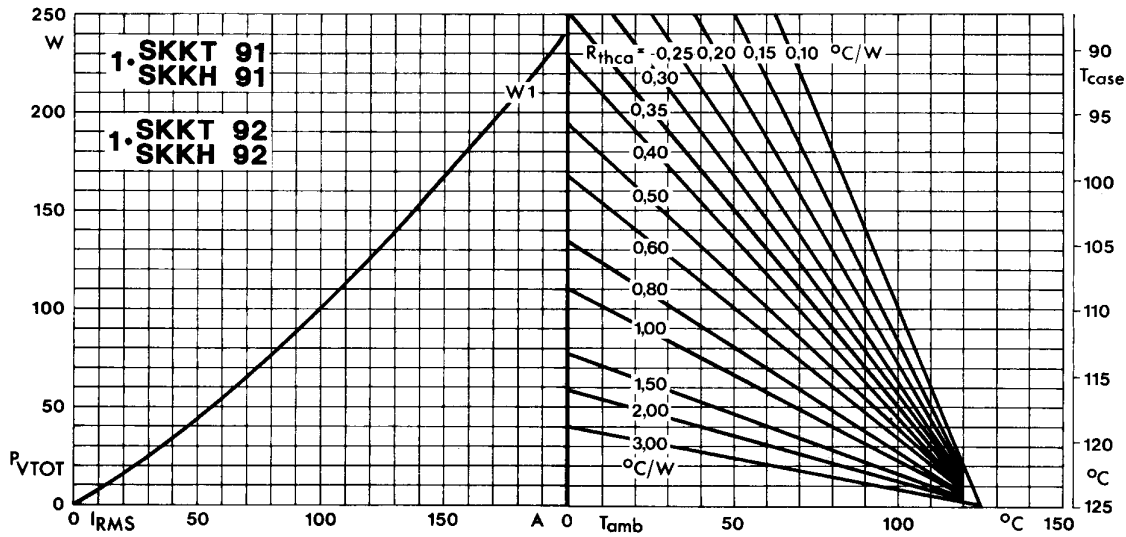

Fig. 2 Power dissipation per module vs. rms current and case temperature

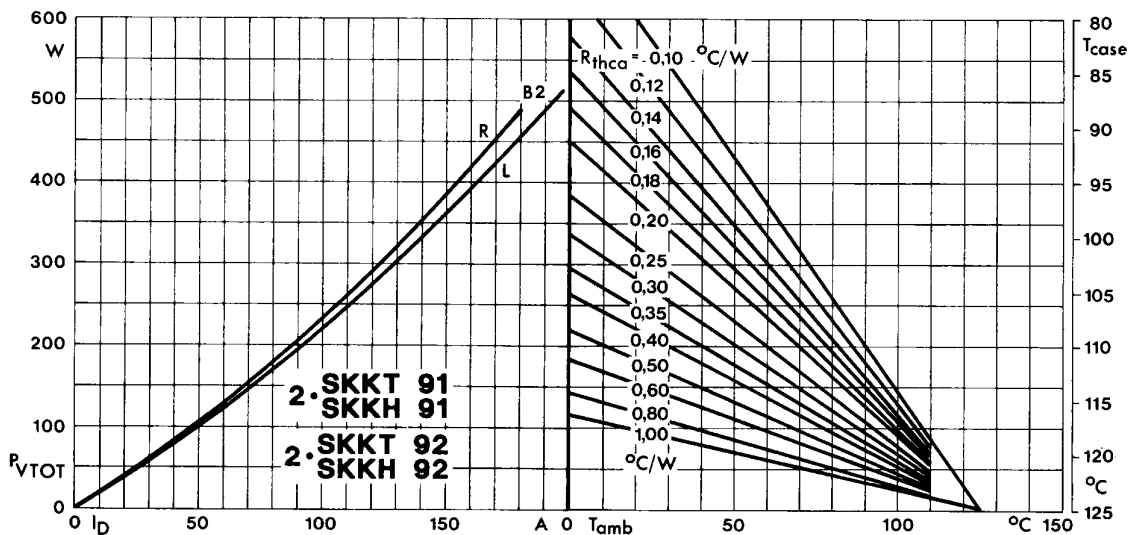

Fig. 3 Power dissipation of two modules vs. direct current and case temperature

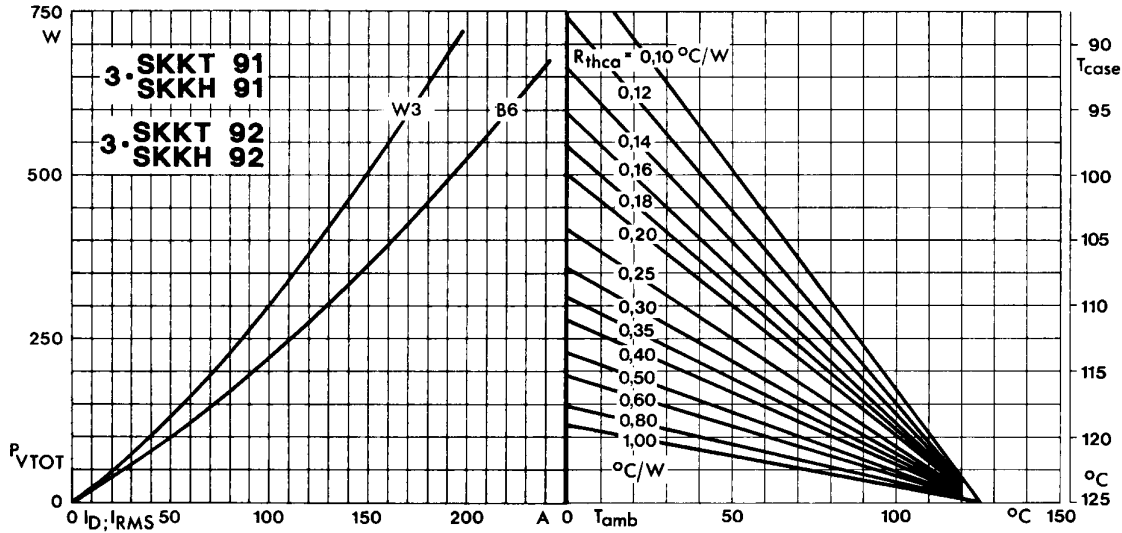

Fig. 4 Power dissipation of three modules vs. direct and rms current and case temperature

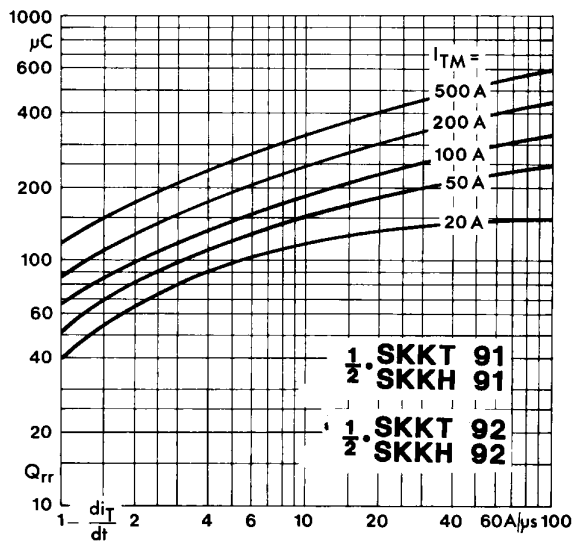

Fig. 5 Recovered charge vs. current decrease

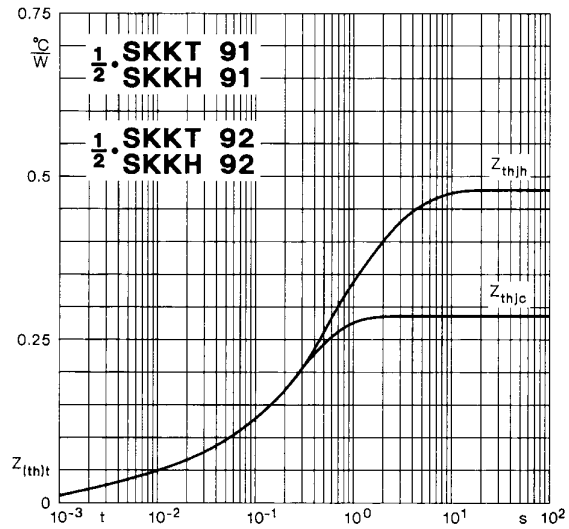

Fig. 6 Transient thermal impedance vs. time

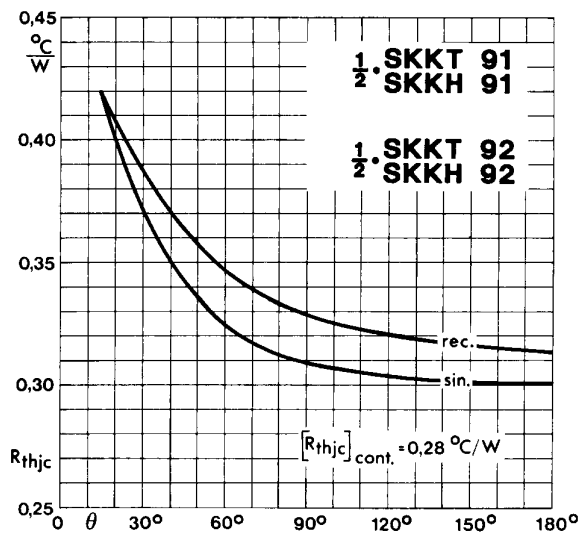

Fig. 7 Thermal resistance vs. conduction angle

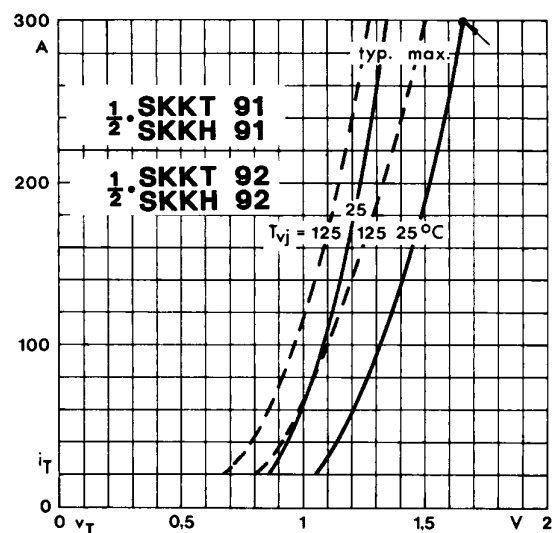

Fig. 8 On-state characteristics

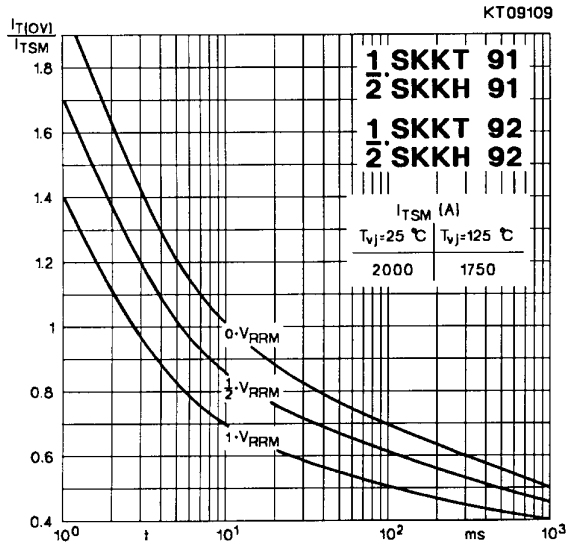

Fig. 9 Surge overload current vs. time

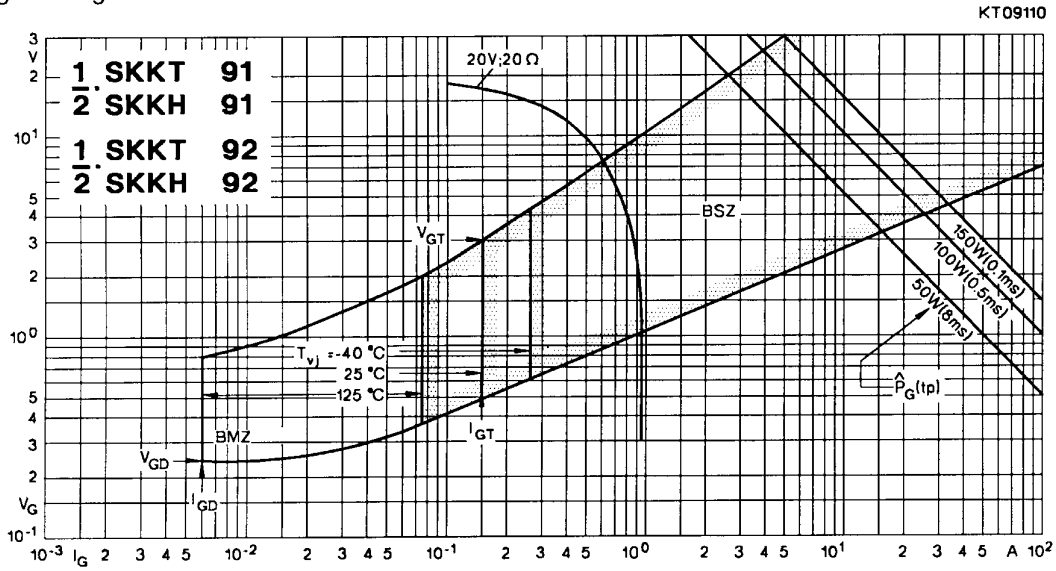

Fig. 10 Gate trigger characteristics

## SKKT 19 ... 105

Case A 5

IEC 192-2: A 77 A

JEDEC: TO-240 AA

SEMIPACK® 1

UL recognized, file no. E 63 532

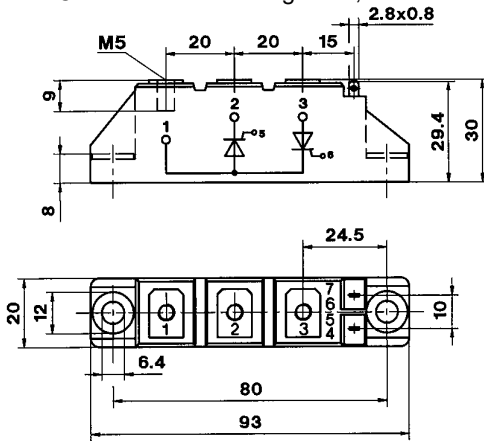

Dimensions in mm

## SKKT 20/ ... 106/

Case A 46

IEC 192-2: A 77 A

JEDEC: TO-240 AA

SEMIPACK® 1

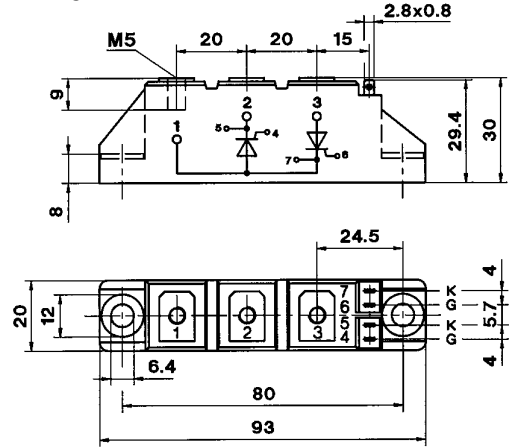

Dimensions in mm

## SKKH 26 ... 105

Case A 6

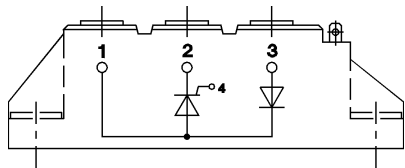

## SKKD 26 ... 100

Case A 10

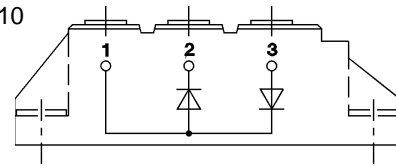

## SKNH 56 ... 91

Case A 7

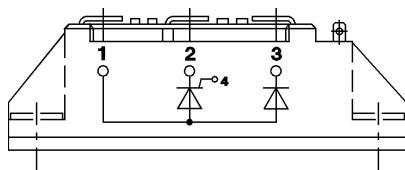

## SKKE 81

Case A 12

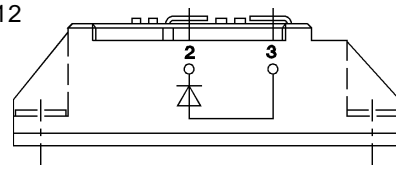

## SKKL 56 ... 105

Case A 9

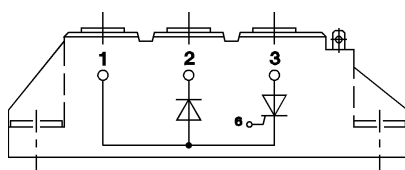

## SKKH 27 ... 106

Case A 47

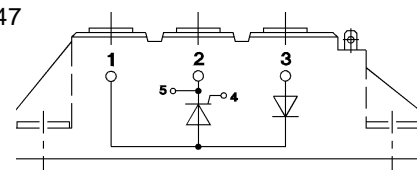

## SKND 46 ... 81

Case A 19

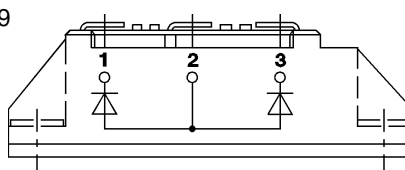

## SKKT 20 B ... 106 B

Case A 48

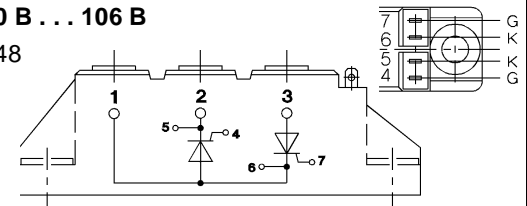

## SKMT 92

Case A 72

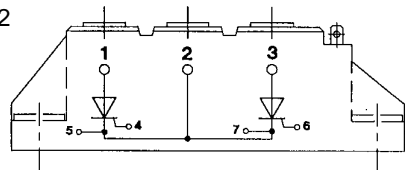

## SKKL 42 ... 106

Case A 59

