

V <sub>RSM</sub>	V <sub>RRM</sub>	(dv/dt) <sub>cr</sub>	I <sub>TRMS</sub> (maximum value for continuous operation)			
			75 A			
V	V	V/μs	I <sub>TAV</sub> (sin. 180; T <sub>case</sub> = 68 °C)			
			48 A			
500	400	500	–	–	SKKH 41/04 D	–
700	600	500	SKKT 41/06 D	SKKT 42/06 D	SKKH 41/06 D	SKKH 42/06 D
900	800	500	SKKT 41/08 D	SKKT 42/08 D <sup>1)</sup>	SKKH 41/08 D	SKKH 42/08 D
1300	1200	1000	SKKT 41/12 E	SKKT 42/12 E <sup>1)</sup>	SKKH 41/12 E	SKKH 42/12 E
1500	1400	1000	SKKT 41/14 E	SKKT 42/14 E <sup>1)</sup>	SKKH 41/14 E	SKKH 42/14 E
1700	1600	1000	SKKT 41/16 E	SKKT 42/16 E <sup>1)</sup>	SKKH 41/16 E	SKKH 42/16 E
1900	1800	1000	SKKT 41/18 E	SKKT 42/18 E <sup>1)</sup>	SKKH 41/18 E	SKKH 42/18 E
2100	2000	1000	SKKT 41/20 E	SKKT 42/20 E <sup>1)</sup>	–	–
2300	2200	1000	SKKT 41/22 E	SKKT 42/22 E <sup>1)</sup>	–	–

## SEMIPACK® 1 Thyristor / Diode Modules

SKKT 41      SKKH 41  
SKKT 42      SKKH 42  
SKKT 42B     SKKL 42<sup>2)</sup>

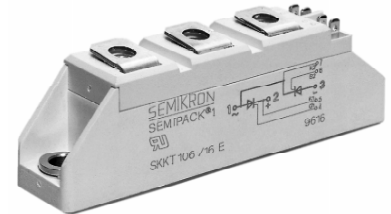

Symbol	Conditions	SKKT 41 SKKH 41	SKKT 42 SKKT 42B SKKH 42	Units
I <sub>TAV</sub>	sin. 180; T <sub>case</sub> = 74 °C	48	48	A
	T <sub>case</sub> = 85 °C	40	40	A
I <sub>D</sub>	B2/B6   T <sub>amb</sub> = 45 °C; P 3/180	50 / 60	50 / 60	A
	T <sub>amb</sub> = 35 °C; P 3/180 F	85 / 110	85 / 110	A
I <sub>RMS</sub>	W1/W3   T <sub>amb</sub> = 35 °C; P 3/180 F	110 / 3 x 85	110 / 3 x 85	A
I <sub>TSM</sub>	T <sub>vj</sub> = 25 °C; 10 ms	1 000	1 000	A
	T <sub>vj</sub> = 125 °C; 10 ms	850	850	A
i <sup>2</sup> t	T <sub>vj</sub> = 25 °C; 8,3 ... 10 ms	5 000	5 000	A <sup>2</sup> s
	T <sub>vj</sub> = 125 °C; 8,3 ... 10 ms	3 600	3 600	A <sup>2</sup> s
t <sub>gd</sub>	T <sub>vj</sub> = 25 °C; I <sub>G</sub> = 1 A di <sub>G</sub> /dt = 1 A/μs	1	1	μs
t <sub>gr</sub>	V <sub>D</sub> = 0,67 · V <sub>DRM</sub>	2	2	μs
(di/dt) <sub>cr</sub>	T <sub>vj</sub> = 125 °C	150	150	A/μs
t <sub>q</sub>	T <sub>vj</sub> = 125 °C	typ. 80	typ. 80	μs
I <sub>H</sub>	T <sub>vj</sub> = 25 °C; typ./max.	150 / 250	150 / 250	mA
I <sub>L</sub>	T <sub>vj</sub> = 25 °C; R <sub>G</sub> = 33 Ω; typ./max.	300 / 600	300 / 600	mA
V <sub>T</sub>	T <sub>vj</sub> = 25 °C; I <sub>T</sub> = 200 A	max. 1,95	max. 1,95	V
V <sub>T(TO)</sub>	T <sub>vj</sub> = 125 °C	1	1	V
r <sub>T</sub>	T <sub>vj</sub> = 125 °C	4,5	4,5	mΩ
I <sub>DD</sub> ; I <sub>RD</sub>	T <sub>vj</sub> = 125 °C; V <sub>RD</sub> = V <sub>RRM</sub> V <sub>DD</sub> = V <sub>DRM</sub>	max. 15 <sup>3)</sup>	max. 15 <sup>3)</sup>	mA
V <sub>GT</sub>	T <sub>vj</sub> = 25 °C; d.c.	3	3	V
I <sub>GT</sub>	T <sub>vj</sub> = 25 °C; d.c.	150	150	mA
V <sub>GD</sub>	T <sub>vj</sub> = 125 °C; d.c.	0,25	0,25	V
I <sub>GD</sub>	T <sub>vj</sub> = 125 °C; d.c.	6	6	mA
R <sub>thjc</sub>	cont. } per thyristor / sin. 180 } per module rec. 120 }	0,65 / 0,33	0,65 / 0,33	°C/W
		0,69 / 0,35	0,69 / 0,35	°C/W
		0,73 / 0,37	0,73 / 0,37	°C/W
R <sub>thch</sub>		0,2 / 0,1	0,2 / 0,1	°C/W
T <sub>vj</sub>		– 40 ... + 125	– 40 ... + 125	°C
T <sub>stg</sub>		– 40 ... + 125	– 40 ... + 125	°C
V <sub>isol</sub>	a. c. 50 Hz; r.m.s.; 1 s/1 min	3600 / 3000	3600 / 3000	V~
M <sub>1</sub>	to heatsink } SI (US) units	5 (44 lb. in.) ± 15 % <sup>4)</sup>	5 (44 lb. in.) ± 15 % <sup>4)</sup>	Nm
M <sub>2</sub>	to terminals }	3 (26 lb. in.) ± 15 %	3 (26 lb. in.) ± 15 %	Nm
a		5 · 9,81	5 · 9,81	m/s <sup>2</sup>
w	approx.	95	95	g
Case	→ page B 1 – 95	SKKT 41: A 5 SKKH 41: A 6 SKKH 42: A 47	SKKL 42: A 59 SKKT 42: A 46 SKKT 42B: A 48	

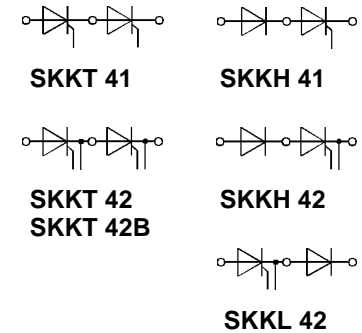

### Features

- Heat transfer through aluminium oxide ceramic isolated metal baseplate
- Hard soldered joints for high reliability
- UL recognized, file no. E 63 532

### Typical Applications

- DC motor control (e.g. for machine tools)
- AC motor soft starters
- Temperature control (e.g. for ovens, chemical processes)
- Professional light dimming (studios, theaters)

<sup>1)</sup> Also available in SKKT 42 B configuration (case A 48)

<sup>2)</sup> SKKL 42 available on request

<sup>3)</sup> /20 E, /22 E max. 30 mA

<sup>4)</sup> See the assembly instructions

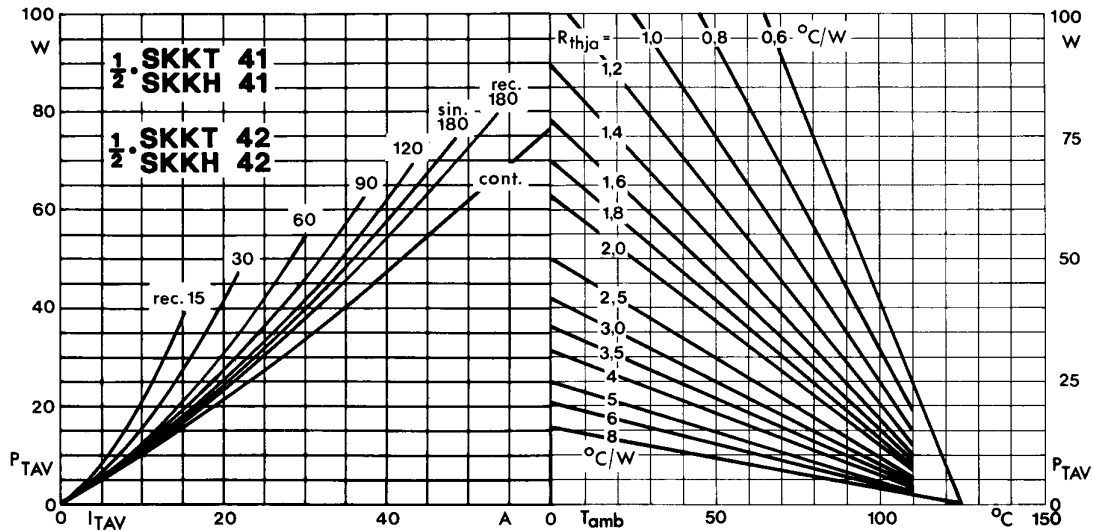

Fig. 1 Power dissipation per thyristor vs. on-state current and ambient temperature

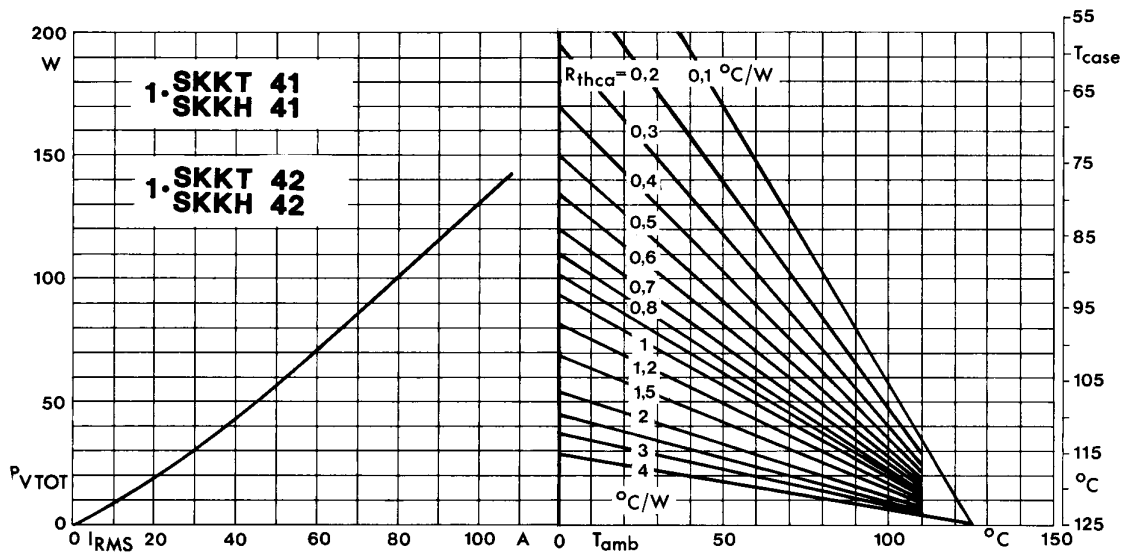

Fig. 2 Power dissipation per module vs. rms current and case temperature

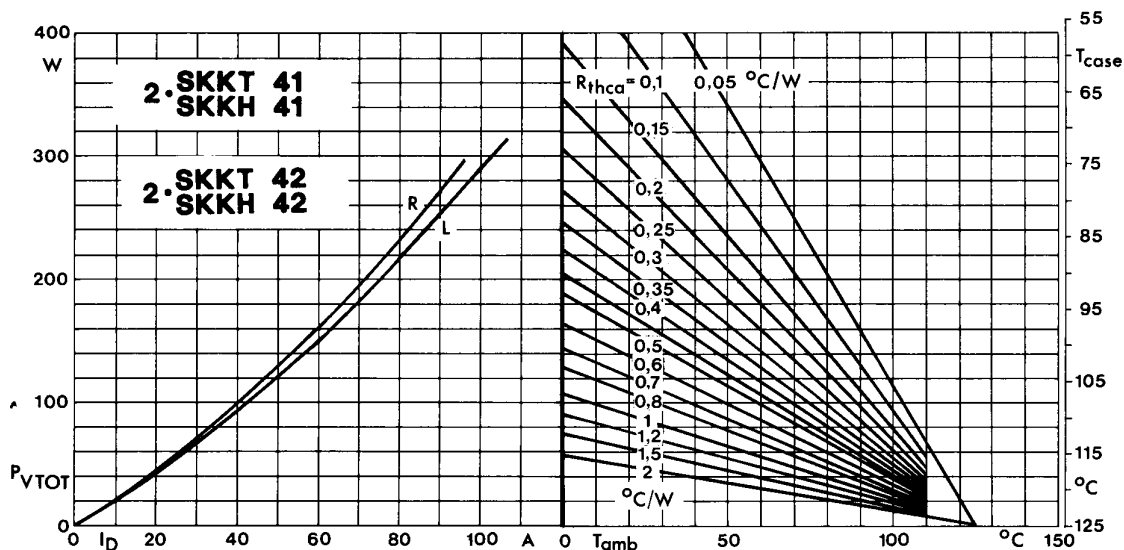

Fig. 3 Power dissipation of two modules vs. direct current and case temperature

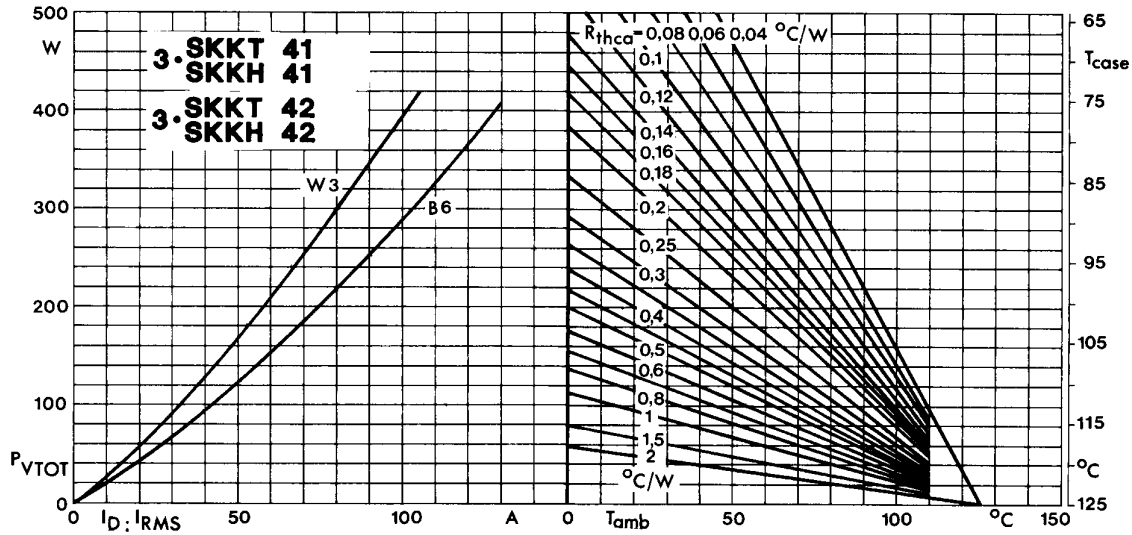

Fig. 4 Power dissipation of three modules vs. direct and rms current and case temperature

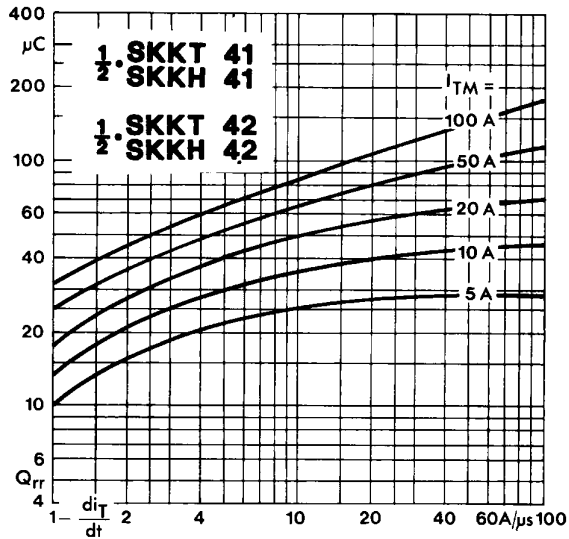

Fig. 5 Recovered charge vs. current decrease

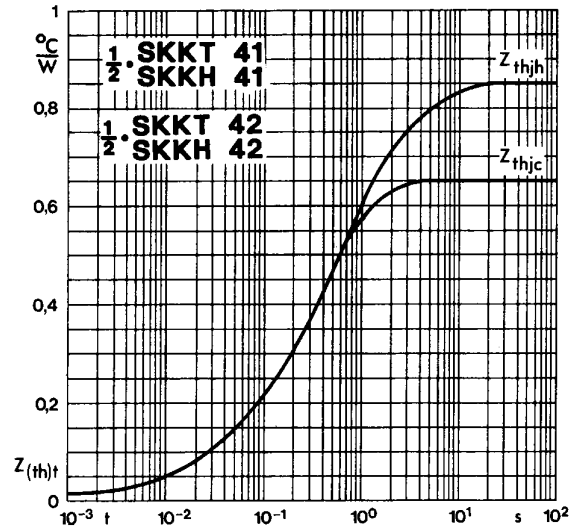

Fig. 6 Transient thermal impedance vs. time

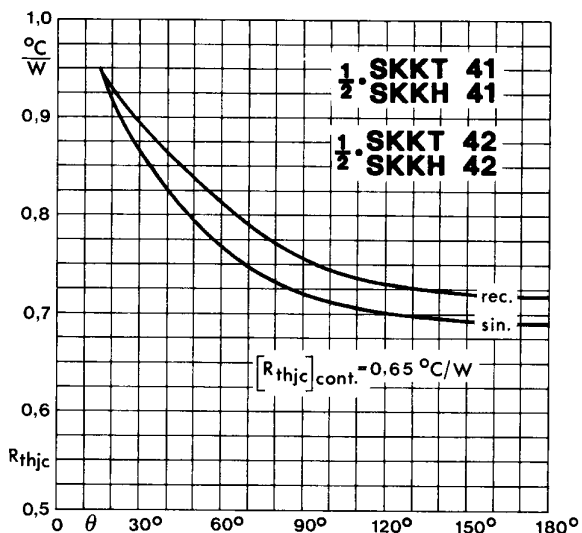

Fig. 7 Thermal resistance vs. conduction angle

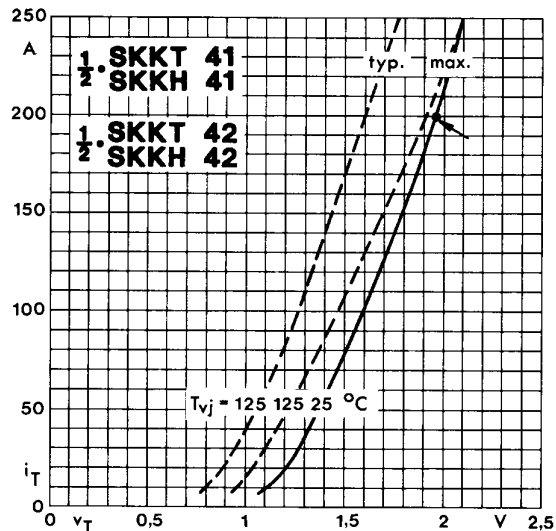

Fig. 8 On-state characteristics

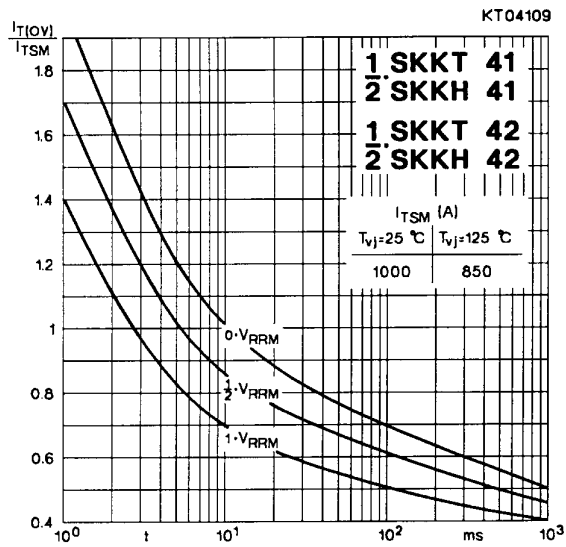

Fig. 9 Surge overload current vs. time

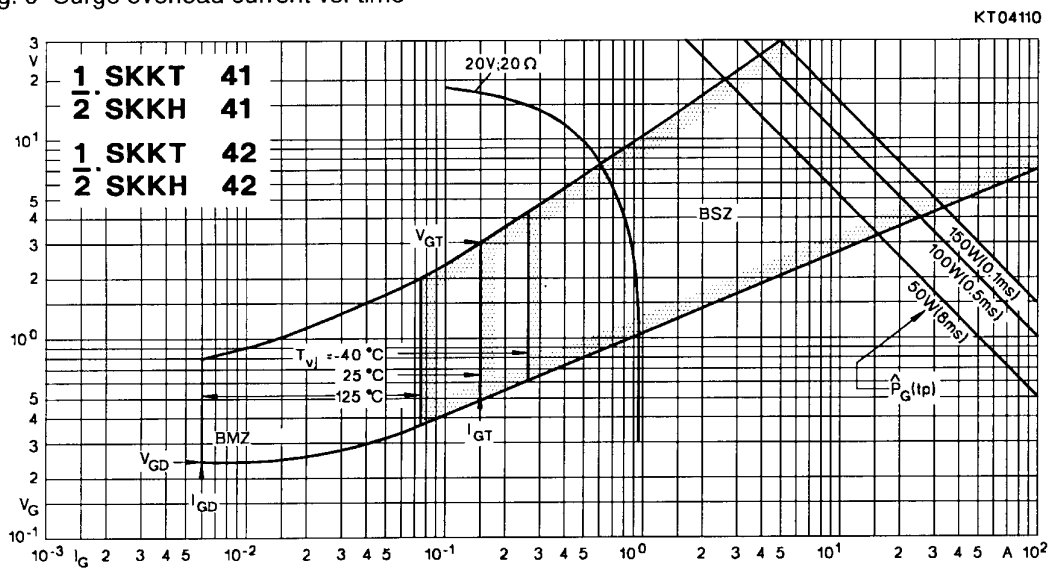

Fig. 10 Gate trigger characteristics

## SKKT 19 ... 105

Case A 5

IEC 192-2: A 77 A

JEDEC: TO-240 AA

SEMIPACK® 1

UL recognized, file no. E 63 532



Dimensions in mm

## SKKT 20/ ... 106/

Case A 46

IEC 192-2: A 77 A

JEDEC: TO-240 AA

SEMIPACK® 1

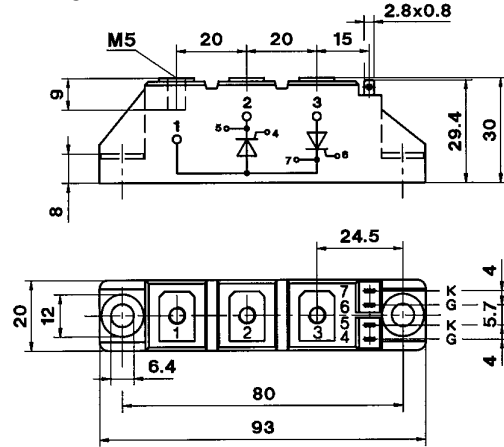

Dimensions in mm

## SKKH 26 ... 105

Case A 6



## SKKD 26 ... 100

Case A 10

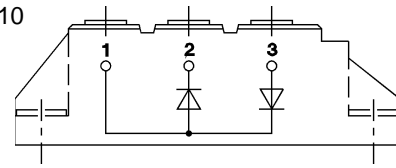

## SKNH 56 ... 91

Case A 7



## SKKE 81

Case A 12

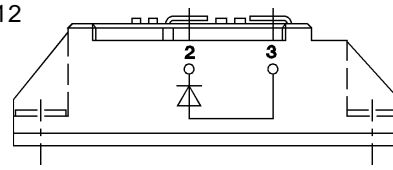

## SKKL 56 ... 105

Case A 9

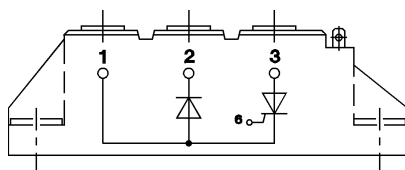

## SKKH 27 ... 106

Case A 47

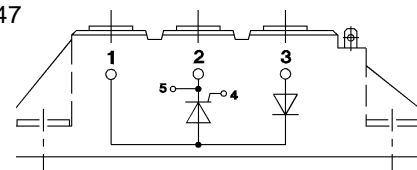

## SKND 46 ... 81

Case A 19



## SKKT 20 B ... 106 B

Case A 48

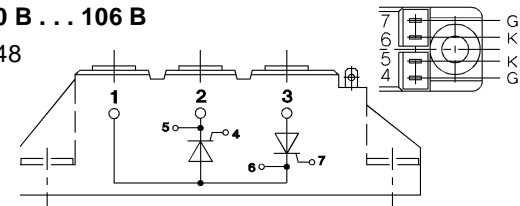

## SKMT 92

Case A 72

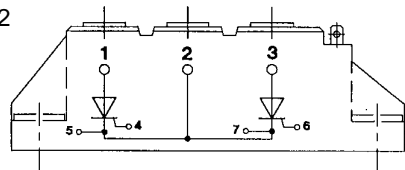

## SKKL 42 ... 106

Case A 59

