

$V_{RSM}$	$V_{RRM}$	$(dv/dt)_{cr}$	$I_{TRMS}$ (maximum value for continuous operation)			
	$V_{DRM}$		150 A			
V	V	V/ $\mu$ s	$I_{TAV}$ (sin. 180; $T_{case} = 85^{\circ}C$ )			
			95 A			
500	400	500	–	–	SKKH 91/04 D	–
700	600	500	SKKT 91/06 D	SKKT 92/06 D	SKKH 91/06 D	SKKH 92/06 D
900	800	500	SKKT 91/08 D	SKKT 92/08 D	SKKH 91/08 D	SKKH 92/08 D
1300	1200	1000	SKKT 91/12 E	SKKT 92/12 E <sup>1)</sup>	SKKH 91/12 E	SKKH 92/12 E
1500	1400	1000	SKKT 91/14 E	SKKT 92/14 E <sup>1)</sup>	SKKH 91/14 E	SKKH 92/14 E
1700	1600	1000	SKKT 91/16 E	SKKT 92/16 E <sup>1)</sup>	SKKH 91/16 E	SKKH 92/16 E
1900	1800	1000	SKKT 91/18 E	SKKT 92/18 E <sup>1)</sup>	SKKH 91/18 E	SKKH 92/18 E

## SEMPACK® 1 Thyristor / Diode Modules

SKKT 91      SKKH 91  
SKKT 92      SKKH 92  
SKKT 92B     SKMT 92<sup>2)</sup>  
SKKL 92<sup>2)</sup>



Symbol	Conditions	SKKT 91 SKKH 91	SKKT 92 SKKT 92B SKKH 92	Units
$I_{TAV}$	sin. 180; $T_{case} = 85^{\circ}C$		95	A
$I_D$	B2/B6 $T_{amb} = 45^{\circ}C$ ; P 3/180		70 / 85	A
	$T_{amb} = 35^{\circ}C$ ; P 3/180 F		140 / 175	A
$I_{RMS}$	W1/W3 $T_{amb} = 35^{\circ}C$ ; P 3/180 F		190 / 3 x 135	A
$I_{TSM}$	$T_{vj} = 25^{\circ}C$ ; 10 ms		2 000	A
	$T_{vj} = 125^{\circ}C$ ; 10 ms		1 750	A
$i^2t$	$T_{vj} = 25^{\circ}C$ ; 8,3 ... 10 ms		20 000	A <sup>2</sup> s
	$T_{vj} = 125^{\circ}C$ ; 8,3 ... 10 ms		15 000	A <sup>2</sup> s
$t_{gd}$	$T_{vj} = 25^{\circ}C$ ; $I_G = 1 A$ ; $di_G/dt = 1 A/\mu s$		1	$\mu s$
$t_{gr}$	$V_D = 0,67 \cdot V_{DRM}$		2	$\mu s$
$(di/dt)_{cr}$	$T_{vj} = 125^{\circ}C$		150	A/ $\mu s$
$t_q$	$T_{vj} = 125^{\circ}C$		typ. 100	$\mu s$
$I_H$	$T_{vj} = 25^{\circ}C$ ; max.		250	mA
$I_L$	$T_{vj} = 25^{\circ}C$ ; $R_G = 33 \Omega$ ; max.		600	mA
$V_T$	$T_{vj} = 25^{\circ}C$ ; $I_T = 300 A$		max. 1,65	V
$V_{T(TO)}$	$T_{vj} = 125^{\circ}C$		0,9	V
$r_T$	$T_{vj} = 125^{\circ}C$		2	m $\Omega$
$I_{DD}$ ; $I_{RD}$	$T_{vj} = 125^{\circ}C$ ; $V_{RD} = V_{RRM}$ $V_{DD} = V_{DRM}$		max. 20	mA
$V_{GT}$	$T_{vj} = 25^{\circ}C$ ; d.c.		3	V
$I_{GT}$	$T_{vj} = 25^{\circ}C$ ; d.c.		150	mA
$V_{GD}$	$T_{vj} = 125^{\circ}C$ ; d.c.		0,25	V
$I_{GD}$	$T_{vj} = 125^{\circ}C$ ; d.c.		6	mA
$R_{thjc}$	cont. } per thyristor / sin. 180 } per module rec. 120 }		0,28 / 0,14 0,30 / 0,15 0,32 / 0,16 0,2 / 0,1	$^{\circ}C/W$ $^{\circ}C/W$ $^{\circ}C/W$ $^{\circ}C/W$
$R_{thch}$				
$T_{vj}$			- 40 ... + 125	$^{\circ}C$
$T_{stg}$			- 40 ... + 125	$^{\circ}C$
$V_{isol}$	a. c. 50 Hz; r.m.s.; 1 s/1 min		3600 / 3000	V~
$M_1$	to heatsink } SI (US) units		5 (44 lb. in.) $\pm 15\%$ <sup>3)</sup>	Nm
$M_2$	to terminals }		3 (26 lb. in.) $\pm 15\%$	Nm
a			5 · 9,81	m/s <sup>2</sup>
w	approx.		95	g
Case	→ page B 1 – 95	SKKT 91: A 5 SKKH 91: A 6	SKKL 92: A 59 SKKT 92: A 46 SKKH 92: A 47	

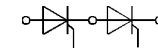

SKKT 91

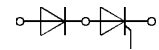

SKKH 91

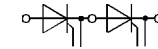

SKKT 92  
SKKT 92B

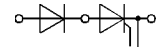

SKKH 92

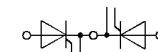

SKMT 92

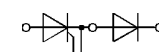

SKKL 92

### Features

- Heat transfer through aluminium oxide ceramic isolated metal baseplate
- Hard soldered joints for high reliability
- UL recognized, file no. E 63 532

### Typical Applications

- DC motor control (e.g. for machine tools)
- AC motor soft starters
- Temperature control (e.g. for ovens, chemical processes)
- Professional light dimming (studios, theaters)

<sup>1)</sup> Also available in SKKT 92B configuration (case A 48)

<sup>2)</sup> SKKL 92, SKMT 92 available on request

<sup>3)</sup> See the assembly instructions

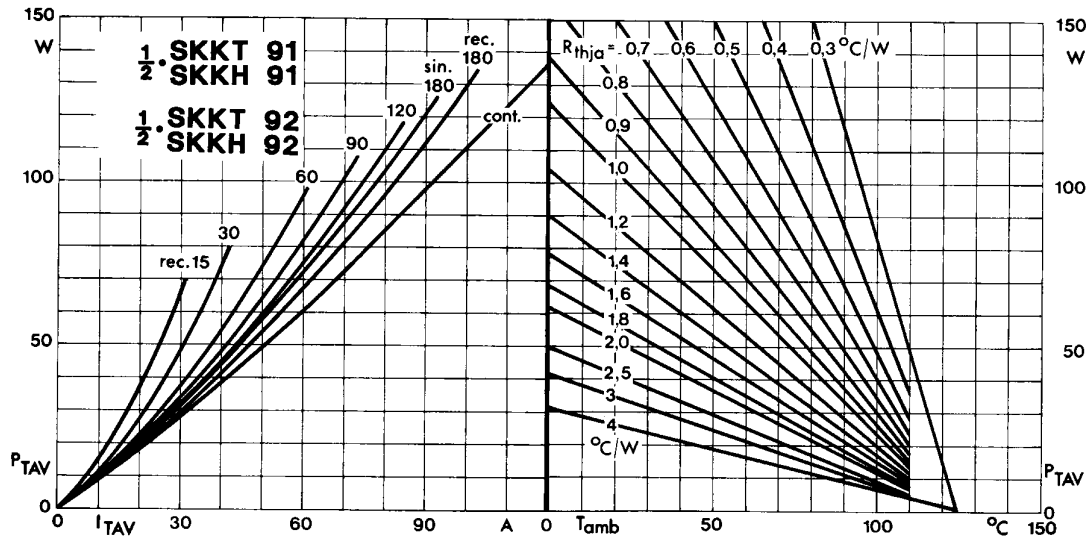

Fig. 1 Power dissipation per thyristor vs. on-state current and ambient temperature

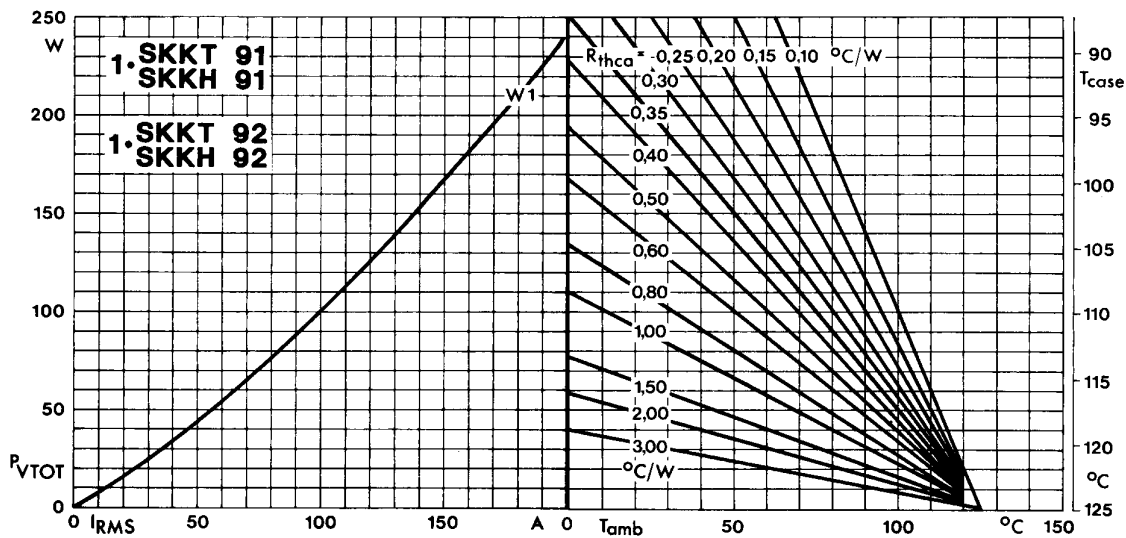

Fig. 2 Power dissipation per module vs. rms current and case temperature

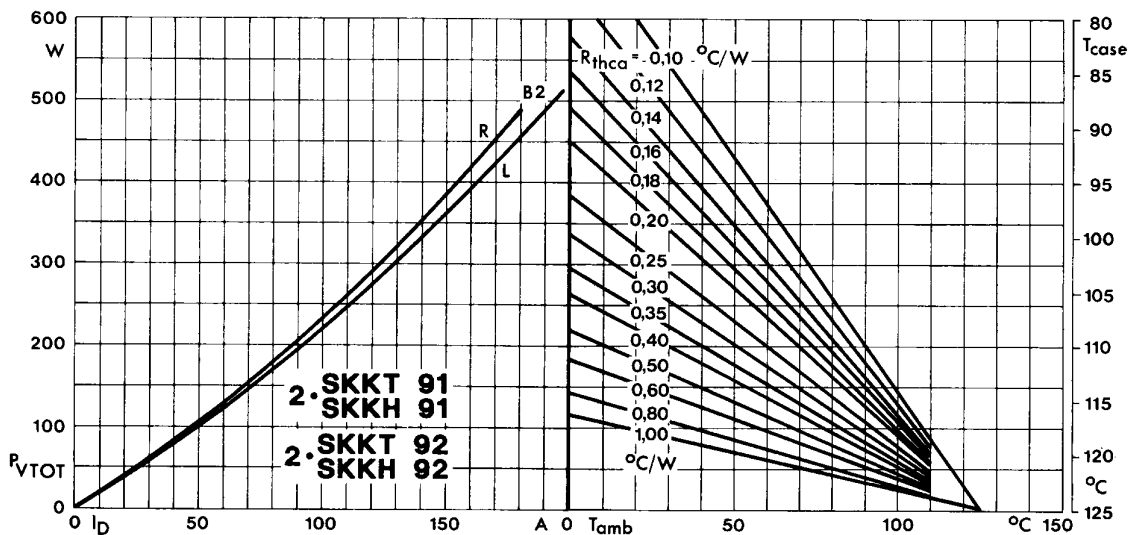

Fig. 3 Power dissipation of two modules vs. direct current and case temperature

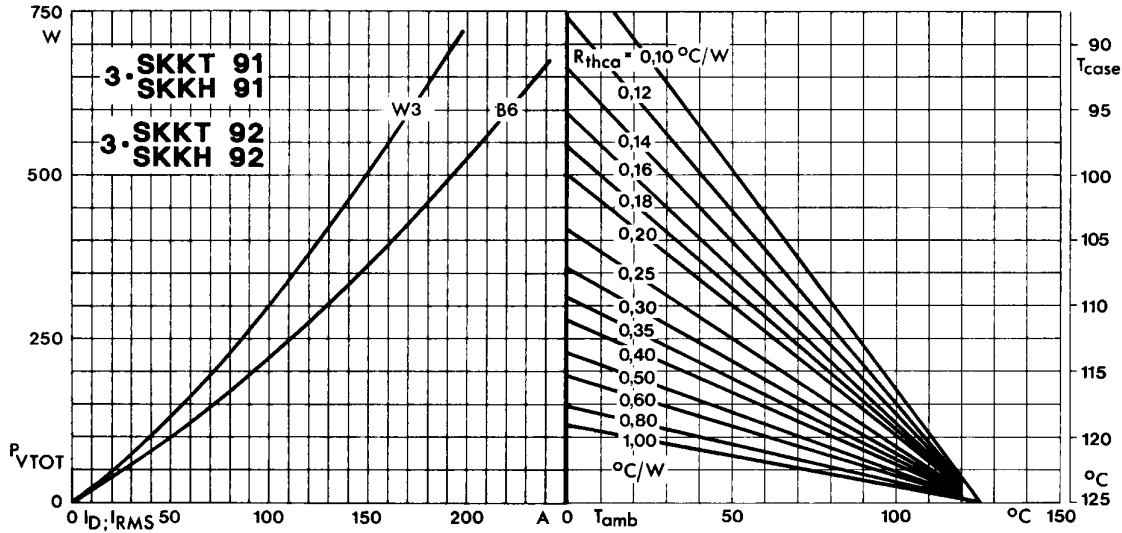

Fig. 4 Power dissipation of three modules vs. direct and rms current and case temperature

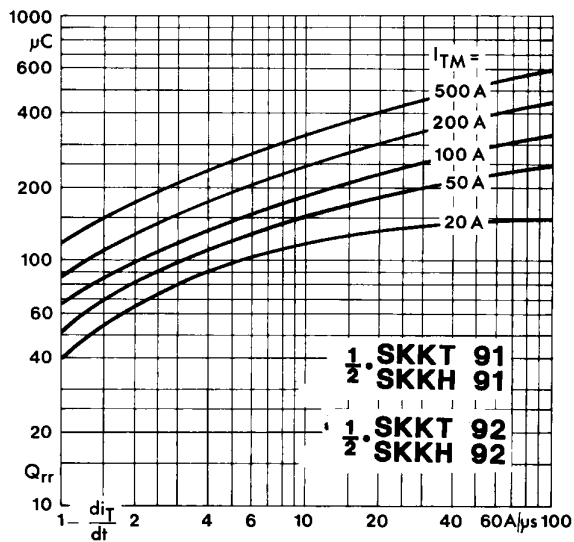

Fig. 5 Recovered charge vs. current decrease

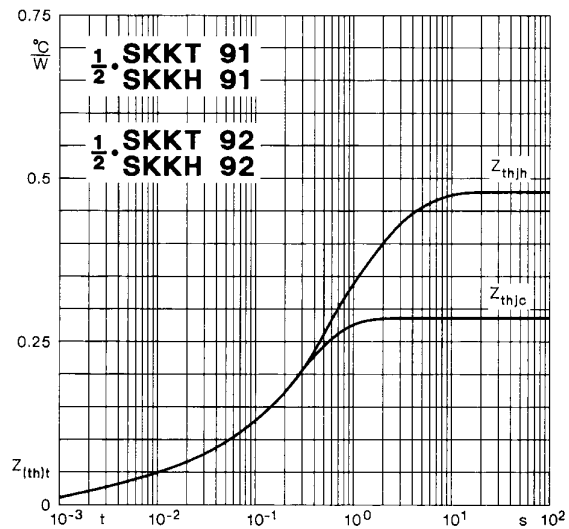

Fig. 6 Transient thermal impedance vs. time

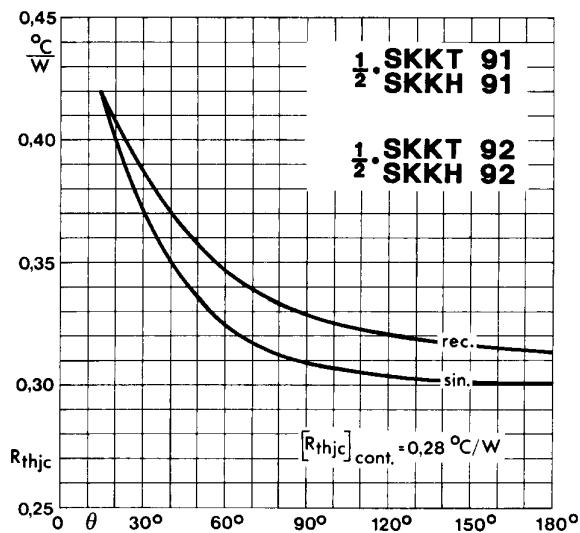

Fig. 7 Thermal resistance vs. conduction angle

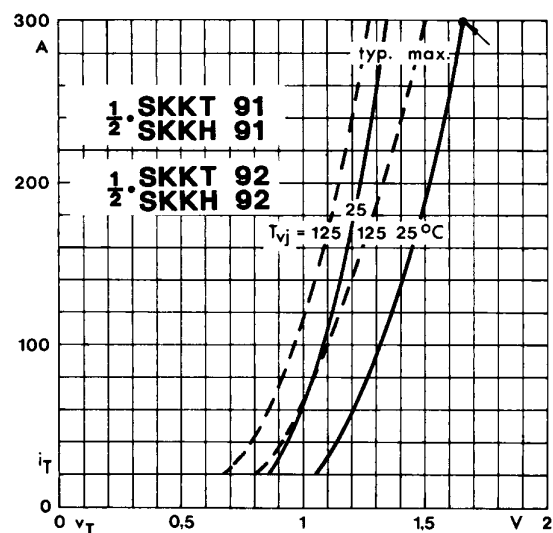

Fig. 8 On-state characteristics

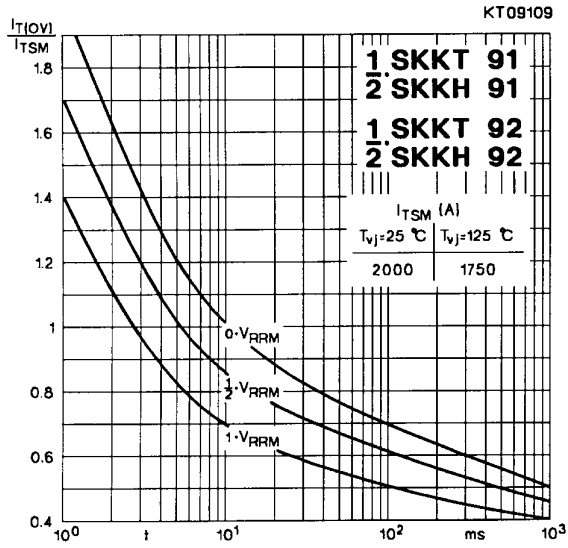

Fig. 9 Surge overload current vs. time

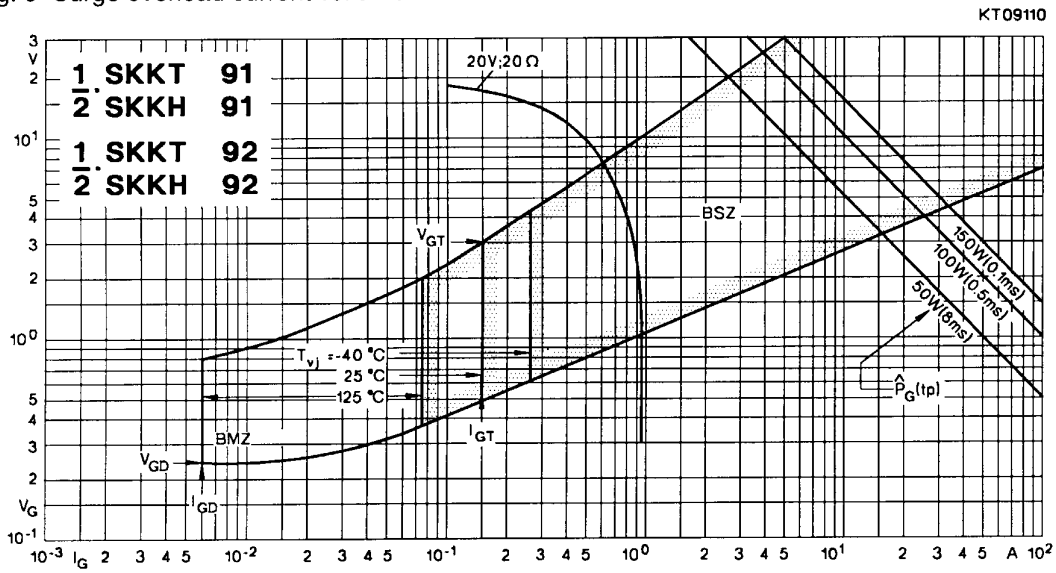

Fig. 10 Gate trigger characteristics

## SKKT 19 ... 105

Case A 5

IEC 192-2: A 77 A

JEDEC: TO-240 AA

SEMIPACK® 1

UL recognized, file no. E 63 532



Dimensions in mm

## SKKT 20/ ... 106/

Case A 46

IEC 192-2: A 77 A

JEDEC: TO-240 AA

SEMIPACK® 1

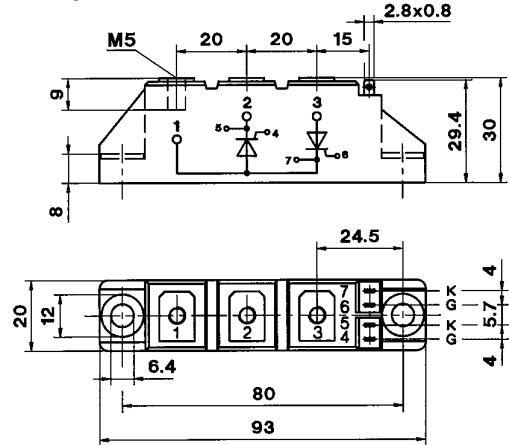

Dimensions in mm

## SKKH 26 ... 105

Case A 6



## SKKD 26 ... 100

Case A 10

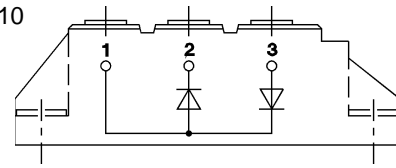

## SKNH 56 ... 91

Case A 7



## SKKE 81

Case A 12

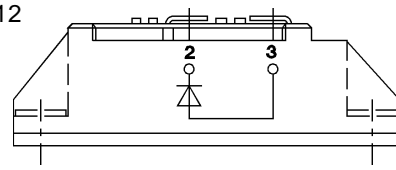

## SKKL 56 ... 105

Case A 9

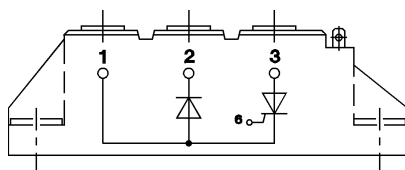

## SKKH 27 ... 106

Case A 47

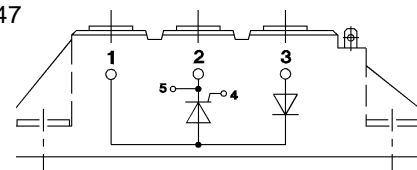

## SKND 46 ... 81

Case A 19



## SKKT 20 B ... 106 B

Case A 48

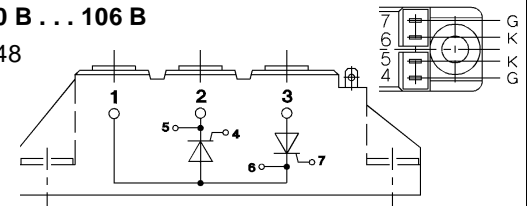

## SKMT 92

Case A 72

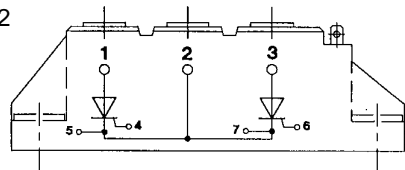

## SKKL 42 ... 106

Case A 59

