

SKD 210



SEMIPONT® 4

Power Bridge Rectifiers

SKD 210

Preliminary Data

Features

- Robust plastic case with screw terminals
- Large, isolated base plate
- Blocking voltage up to 1800 V
- High surge currents
- Three phase bridge rectifier
- Easy chassis mounting
- UL recognition applied for file no. E 63 532

Typical Applications

- Three phase rectifiers for power supplies
- Input rectifiers for variable frequency drives
- Rectifiers for DC motor field supplies
- Battery charger rectifiers

1) Max. output current limited by the terminals: 220A rms

V_{RSM} V	V_{RRM}, V_{DRM} V	$I_D = 210$ A (full conduction) ($T_c = 99$ °C)
900	800	SKD 210/08
1300	1200	SKD 210/12
1700	1600	SKD 210/16
1900	1800	SKD 210/18

Symbol	Conditions	Values	Units
I_D	$T_c = 100$ °C	207	A
I_D	$T_c = 95$ °C	220 ¹⁾	A
I_{FSM}	$T_{vj} = 25$ °C; 10 ms	2000	A
	$T_{vj} = 150$ °C; 10 ms	1600	A
i^2t	$T_{vj} = 25$ °C; 8,3 ... 10 ms	20000	A ² s
	$T_{vj} = 150$ °C; 8,3 ... 10 ms	12800	A ² s
V_F	$T_{vj} = 25$ °C; $I_F = 300$ A	max. 1,65	V
$V_{(TO)}$	$T_{vj} = 150$ °C	max. 0,85	V
r_T	$T_{vj} = 150$ °C	max. 3	mΩ
I_{RD}	$T_{vj} = 25$ °C; $V_{DD} = V_{DRM}$; $V_{RD} = V_{RRM}$	max. 0,5	mA
	$T_{vj} = 150$ °C; $V_{RD} = V_{RRM}$	6	mA
$R_{th(j-c)}$	per diode	0,5	K/W
	total	0,083	K/W
$R_{th(c-s)}$	total	0,03	K/W
T_{vj}		- 40 ... + 150	°C
T_{stg}		- 40 ... + 125	°C
V_{isol}	a. c. 50 Hz; r.m.s.; 1 s / 1 min.	3600 (3000)	V
M_s	to heatsink	5 ± 15 %	Nm
M_t	to terminals	5 ± 15 %	Nm
m		270	g
Case		G 37	

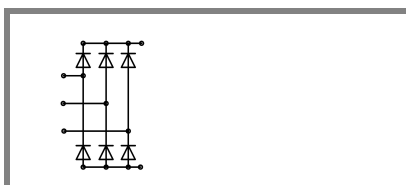

SKD

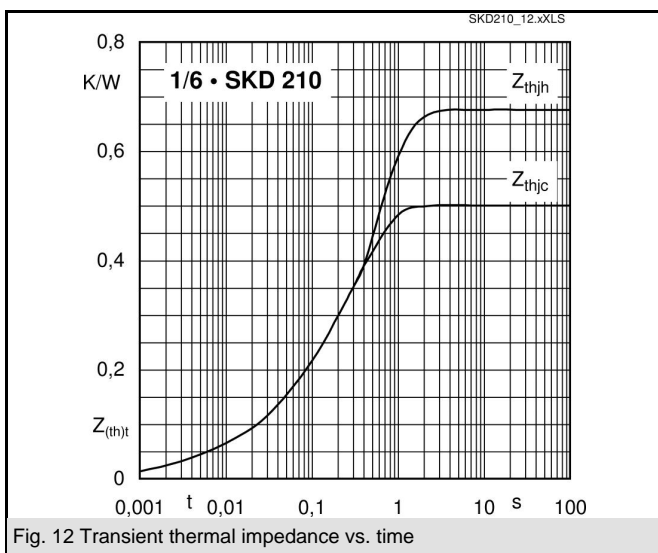
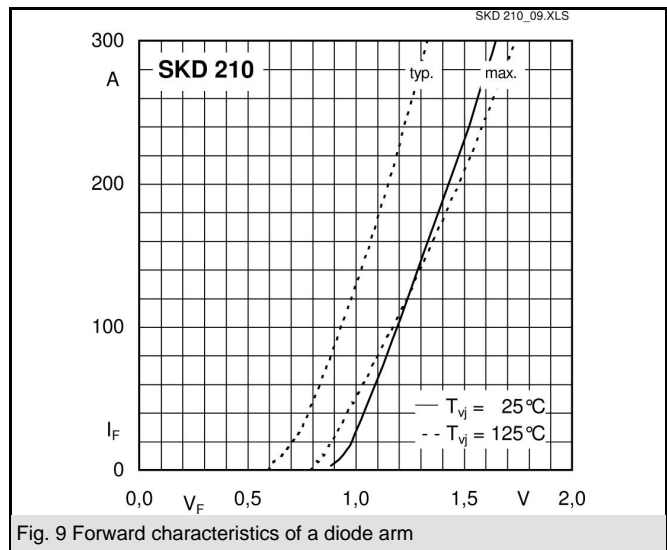
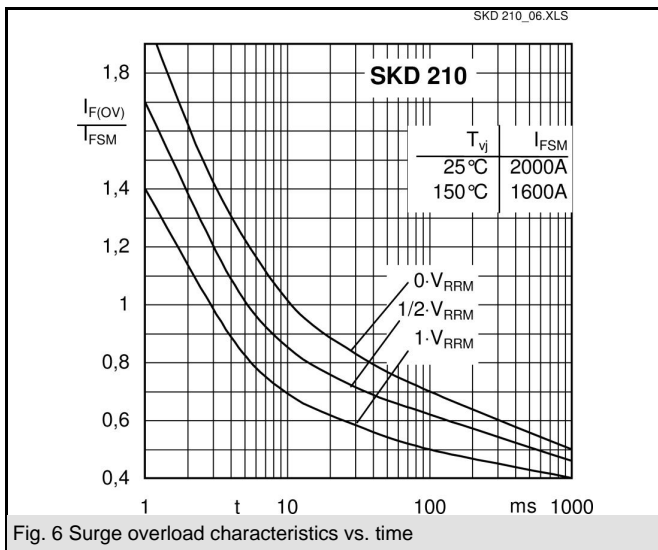
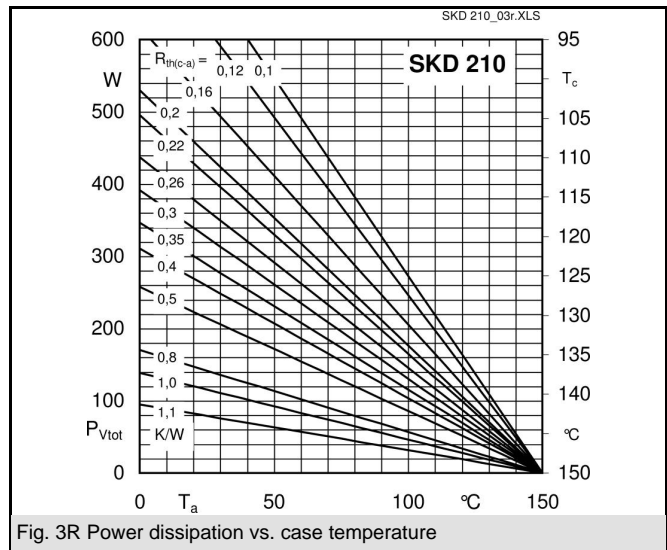
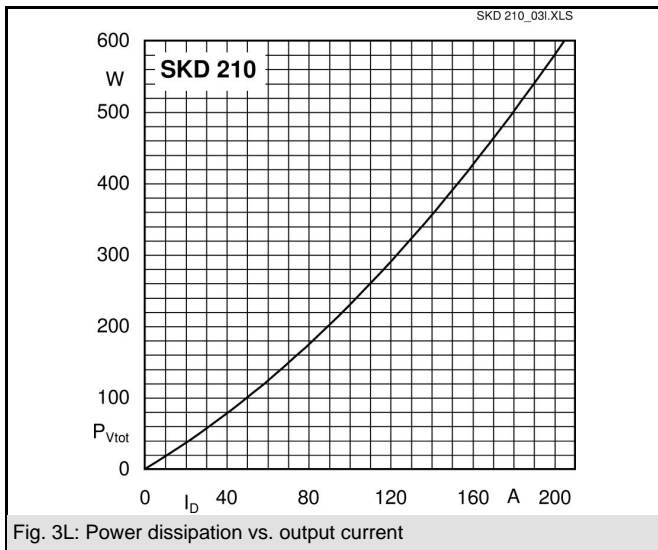

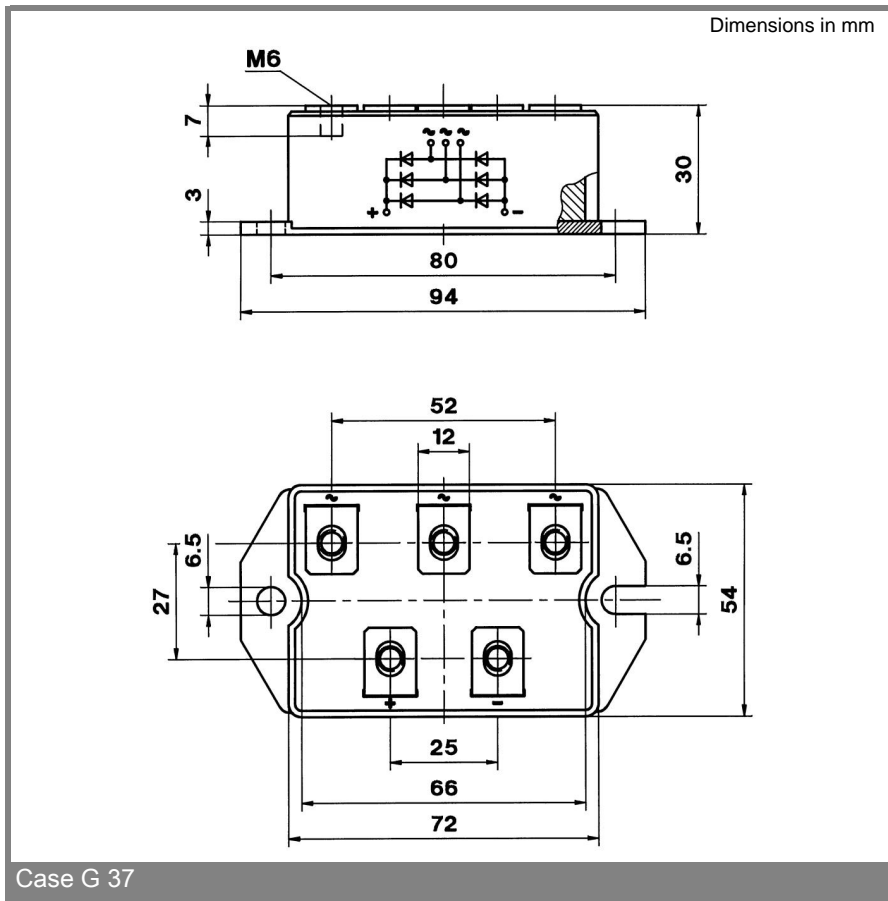

Case G 37

This technical information specifies semiconductor devices but promises no characteristics. No warranty or guarantee expressed or implied is made regarding delivery, performance or suitability.