

Product Preview

POWERTAP™ II
SWITCHMODE™ Power Rectifier

The SWITCHMODE Power Rectifier uses the Schottky Barrier principle with a platinum barrier metal. This state-of-the-art device has the following features:

- Dual Diode Construction — May Be Paralleled for Higher Current Output
- Guardring for Stress Protection
- Low Forward Voltage Drop
- 150°C Operating Junction Temperature
- Recyclable Epoxy
- Guaranteed Reverse Avalanche Energy Capability
- Improved Mechanical Ratings

Mechanical Characteristics

- Case: Epoxy, Molded with metal heatsink base
- Weight: 80 grams (approximately)
- Finish: All External Surfaces Corrosion Resistant
- Top Terminal Torque: 25–40 lb-in max
- Base Plate Torques: See procedure given in the Package Outline Section
- Shipped 25 units per foam
- Marking: B60035L

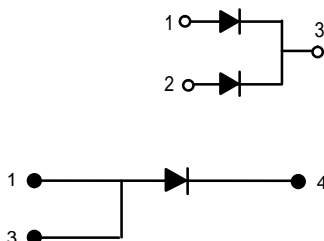

MBRP60035CTL

Motorola Preferred Device

LOW V_F
SCHOTTKY BARRIER
RECTIFIER
600 AMPERES
35 VOLTS

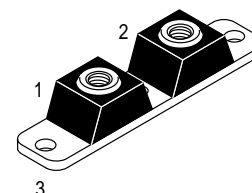

CASE 357C-03
POWERTAP II

MAXIMUM RATINGS

Rating	Symbol	Value	Unit
Peak Repetitive Reverse Voltage Working Peak Reverse Voltage DC Blocking Voltage	V_{RRM} V_{RWM} V_R	35	Volts
Average Rectified Forward Current (At Rated V_R , $T_C = +100^\circ\text{C}$)	$I_{F(AV)}$	300 600	Amps Per Leg Per Device
Peak Repetitive Forward Current (At Rated V_R , Square Wave, 20 kHz) $T_C = +100^\circ\text{C}$	I_{FRM}	300	Amps
Non-repetitive Peak Surge Current (Surge applied at rated load conditions halfwave, single phase, 60 Hz)	I_{FSM}	4000	Amps
Peak Repetitive Reverse Surge Current (2 μs , 1 kHz)	I_{RRM}	2	Amp
Storage Temperature	T_{stg}	-55 to +150	$^\circ\text{C}$
Operating Junction Temperature	T_J	-55 to +150	$^\circ\text{C}$
Voltage Rate of Change (Rated V_R)	dv/dt	10000	$\text{V}/\mu\text{s}$

THERMAL CHARACTERISTICS

Thermal Resistance — Junction to Case	$R_{\theta JC}$	0.4	$^\circ\text{C}/\text{W}$
---------------------------------------	-----------------	-----	---------------------------

ELECTRICAL CHARACTERISTICS

Maximum Instantaneous Forward Voltage (2) ($i_F = 300$ Amps, $T_C = +25^\circ\text{C}$) ($i_F = 300$ Amps, $T_C = +100^\circ\text{C}$)	V_F	0.57 0.50	Volts
Maximum Instantaneous Reverse Current (2) (Rated dc Voltage, $T_C = +25^\circ\text{C}$) (Rated dc Voltage, $T_C = +100^\circ\text{C}$)	I_R	10 250	mA

(1) Rating applies when surface mounted on the minimum pad size recommended.

(2) Pulse Test: Pulse Width = 300 μs , Duty Cycle $\leq 2\%$.

POWERTAP II and SWITCHMODE are trademarks of Motorola, Inc.

This document contains information on a product under development. Motorola reserves the right to change or discontinue this product without notice.

Preferred devices are Motorola recommended choices for future use and best overall value.

MBRP60035CTL

MAXIMUM MECHANICAL RATINGS

Terminal Penetration:	0.235 max
Terminal Torque:	25–40 in-lb max
Mounting Torque — Outside Holes:	30–40 in-lb max
Mounting Torque — Center Hole:	8–10 in-lb max
Seating Plane Flatness	1 mil per in. (between mounting holes)

POWERTAP MECHANICAL DATA APPLIES OVER OPERATING TEMPERATURE

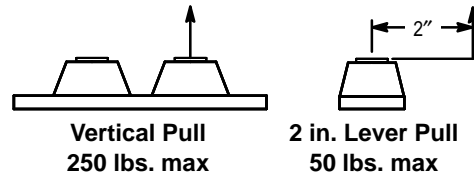

Note: While the POWERTAP is capable of sustaining these vertical and levered tensions, the intimate contact between POWERTAP and heat sink may be lost. This could lead to thermal runaway. The use of very flexible leads is recommended for the anode connections. Use of thermal grease is highly recommended.

MOUNTING PROCEDURE

The POWERTAP package requires special mounting considerations because of the long longitudinal axis of the copper heat sink. It is important to follow the proper tightening sequence to avoid warping the heat sink, which can reduce thermal contact between the POWERTAP and heat sink.

STEP 1:

Locate the POWERTAP on the heat sink and start mounting bolts into the threads by hand (2 or 3 turns).

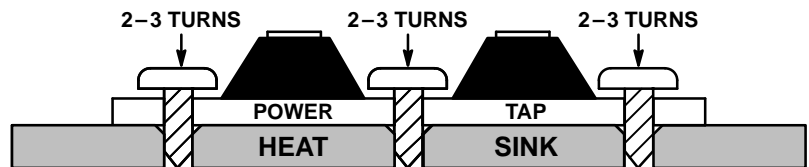

STEP 2:

Finger tighten the center bolt. The bolt may catch on the threads of the heat sink so it is important to make sure the face of the bolt or washer is in contact with the surface of the POWERTAP.

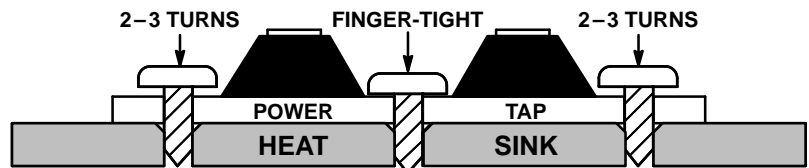

STEP 3:

Tighten each of the end bolts between 5 to 10 in-lb.

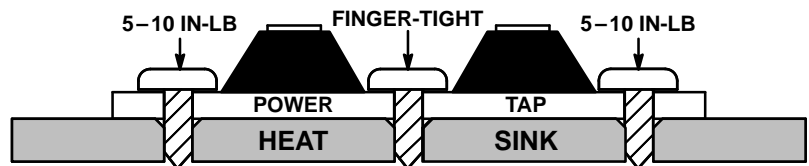

STEP 4:

Tighten the center bolt between 8 to 10 in-lb.

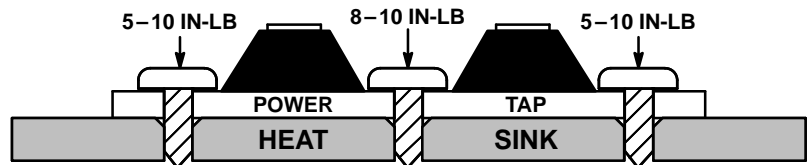

STEP 5:

Finally, tighten the end bolts between 30 to 40 in-lb.

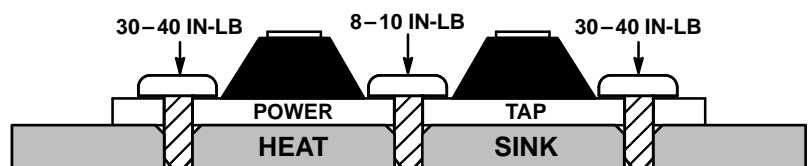

PACKAGE DIMENSIONS

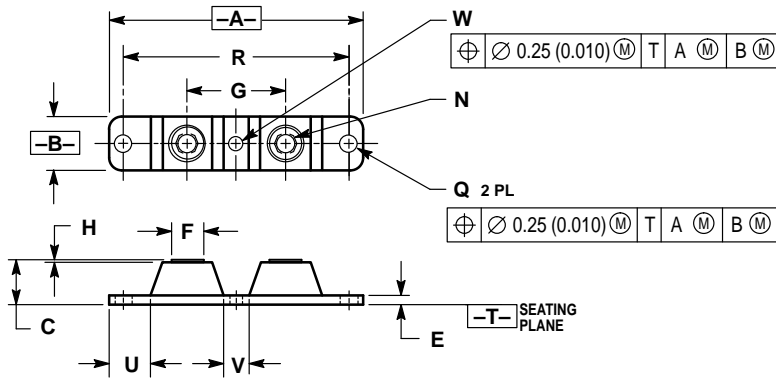

NOTES:

1. DIMENSIONING AND TOLERANCING PER ANSI Y14.5M, 1982.
2. CONTROLLING DIMENSION: INCH.
3. TERMINAL PENETRATION: 5.97 (0.235) MAXIMUM.

DIM	INCHES		MILLIMETERS	
	MIN	MAX	MIN	MAX
A	3.450	3.635	87.63	92.33
B	0.700	0.810	17.78	20.57
C	0.615	0.640	15.53	16.26
E	0.120	0.130	3.05	3.30
F	0.435	0.445	11.05	11.30
G	1.370	1.380	34.80	35.05
H	0.007	0.030	0.18	0.76
N	1/4-20UNC-2B		1/4-20UNC-2B	
Q	0.270	0.285	6.86	7.32
R	31.50 BSC		80.01 BSC	
U	0.600	0.630	15.24	16.00
V	0.330	0.375	8.39	9.52
W	0.170	0.190	4.32	4.82

CASE 357C-03
ISSUE C

Motorola reserves the right to make changes without further notice to any products herein. Motorola makes no warranty, representation or guarantee regarding the suitability of its products for any particular purpose, nor does Motorola assume any liability arising out of the application or use of any product or circuit, and specifically disclaims any and all liability, including without limitation consequential or incidental damages. "Typical" parameters which may be provided in Motorola data sheets and/or specifications can and do vary in different applications and actual performance may vary over time. All operating parameters, including "Typicals" must be validated for each customer application by customer's technical experts. Motorola does not convey any license under its patent rights nor the rights of others. Motorola products are not designed, intended, or authorized for use as components in systems intended for surgical implant into the body, or other applications intended to support or sustain life, or for any other application in which the failure of the Motorola product could create a situation where personal injury or death may occur. Should Buyer purchase or use Motorola products for any such unintended or unauthorized application, Buyer shall indemnify and hold Motorola and its officers, employees, subsidiaries, affiliates, and distributors harmless against all claims, costs, damages, and expenses, and reasonable attorney fees arising out of, directly or indirectly, any claim of personal injury or death associated with such unintended or unauthorized use, even if such claim alleges that Motorola was negligent regarding the design or manufacture of the part. Motorola and  are registered trademarks of Motorola, Inc. Motorola, Inc. is an Equal Opportunity/Affirmative Action Employer.

Mfax is a trademark of Motorola, Inc.

How to reach us:

USA/EUROPE/Locations Not Listed: Motorola Literature Distribution;
P.O. Box 5405, Denver, Colorado 80217. 303-675-2140 or 1-800-441-2447

JAPAN: Nippon Motorola Ltd.; Tatsumi-SPD-JLDC, 6F Seibu-Butsuryu-Center,
3-14-2 Tatsumi Koto-Ku, Tokyo 135, Japan. 81-3-3521-8315

Mfax™: RMFAX0@email.sps.mot.com – TOUCHTONE 602-244-6609
INTERNET: <http://Design-NET.com>

ASIA/PACIFIC: Motorola Semiconductors H.K. Ltd.; 8B Tai Ping Industrial Park,
51 Ting Kok Road, Tai Po, N.T., Hong Kong. 852-26629298

