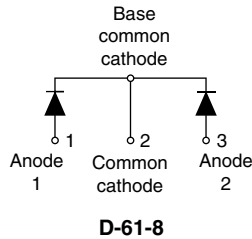
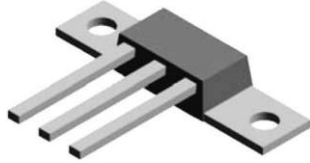

## Schottky Rectifier

### New Generation 3 D-61 Package, 2 x 40 A

**FEATURES**

- 150 °C  $T_J$  operation
- Dual center tap module
- Very low forward voltage drop
- High frequency operation
- High purity, high temperature epoxy encapsulation for enhanced mechanical strength and moisture resistance
- Guard ring for enhanced ruggedness and long term reliability
- New fully transfer-mould low profile, small footprint, high current package
- Through-hole versions are currently available for use in lead (Pb)-free applications ("PbF" suffix)
- Designed and qualified for industrial level

**RoHS\***  
COMPLIANT

**PRODUCT SUMMARY**

$I_{F(AV)}$	2 x 40 A
$V_R$	30 V

**DESCRIPTION**

The center tap Schottky rectifier module has been optimized for very low forward voltage drop, with moderate leakage. The proprietary barrier technology allows for reliable operation up to 150 °C junction temperature. Typical applications are in switching power supplies, converters, freewheeling diodes, and reverse battery protection.

**MAJOR RATINGS AND CHARACTERISTICS**

SYMBOL	CHARACTERISTICS	VALUES	UNITS
$I_{F(AV)}$	Rectangular waveform	80	A
$V_{RRM}$		30	V
$I_{FSM}$	$t_p = 5 \mu s$ sine	5100	A
$V_F$	40 Apk, $T_J = 125 \text{ }^\circ\text{C}$ (per leg)	0.37	V
$T_J$	Range	- 55 to 150	$^\circ\text{C}$

**VOLTAGE RATINGS**

PARAMETER	SYMBOL	82CNQ030APbF	UNITS
Maximum DC reverse voltage	$V_R$	30	V
Maximum working peak reverse voltage	$V_{RWM}$		

**ABSOLUTE MAXIMUM RATINGS**

PARAMETER	SYMBOL	TEST CONDITIONS	VALUES	UNITS
Maximum average forward current See fig. 5	$I_{F(AV)}$	50 % duty cycle at $T_C = 119 \text{ }^\circ\text{C}$ , rectangular waveform	80	A
Maximum peak one cycle non-repetitive surge current per leg See fig. 7	$I_{FSM}$	5 $\mu s$ sine or 3 $\mu s$ rect. pulse	5100	
		10 ms sine or 6 ms rect. pulse	880	
Non-repetitive avalanche energy per leg	$E_{AS}$	$T_J = 25 \text{ }^\circ\text{C}$ , $I_{AS} = 8 \text{ A}$ , $L = 1.12 \text{ mH}$	36	mJ
Repetitive avalanche current per leg	$I_{AR}$	Current decaying linearly to zero in 1 $\mu s$ Frequency limited by $T_J$ maximum $V_A = 1.5 \times V_R$ typical	8	A

\* Pb containing terminations are not RoHS compliant, exemptions may apply

ELECTRICAL SPECIFICATIONS					
PARAMETER	SYMBOL	TEST CONDITIONS		VALUES	UNITS
Maximum forward voltage drop per leg See fig. 1	$V_{FM}^{(1)}$	40 A	$T_J = 25\text{ }^\circ\text{C}$	0.47	V
		80 A		0.55	
		40 A	$T_J = 125\text{ }^\circ\text{C}$	0.37	
		80 A		0.47	
Maximum reverse leakage current per leg See fig. 2	$I_{RM}^{(1)}$	$T_J = 25\text{ }^\circ\text{C}$	$V_R = \text{Rated } V_R$	5	mA
		$T_J = 125\text{ }^\circ\text{C}$		280	
Maximum junction capacitance per leg	$C_T$	$V_R = 5\text{ }V_{DC}$ (test signal range 100 kHz to 1 MHz) $25\text{ }^\circ\text{C}$		3700	pF
Typical series inductance per leg	$L_S$	Measured lead to lead 5 mm from package body		5.5	nH
Maximum voltage rate of change	dV/dt	Rated $V_R$		10 000	V/ $\mu$ s

**Note**(1) Pulse width < 300  $\mu$ s, duty cycle < 2 %

THERMAL - MECHANICAL SPECIFICATIONS					
PARAMETER	SYMBOL	TEST CONDITIONS		VALUES	UNITS
Maximum junction and storage temperature range	$T_J, T_{Stg}$			- 55 to 150	$^\circ\text{C}$
Maximum thermal resistance, junction to case	$R_{thJC}$	DC operation	See fig. 4	0.85	$^\circ\text{C}/\text{W}$
		DC operation		0.42	
Typical thermal resistance, case to heatsink	$R_{thCS}$	Mounting surface, smooth and greased Device flatness < 5 mils		0.30	
Approximate weight				7.8	g
				0.28	oz.
Mounting torque	minimum			40 (35)	kgf · cm (lbf · in)
	maximum			58 (50)	
Marking device		Case style D-61		82CNQ030A	

## Schottky Rectifier New Generation 3 D-61 Package, 2 x 40 A

Vishay High Power Products

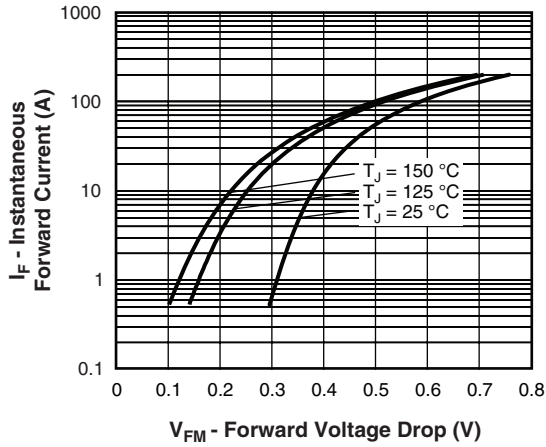

Fig. 1 - Maximum Forward Voltage Drop Characteristics (Per Leg)

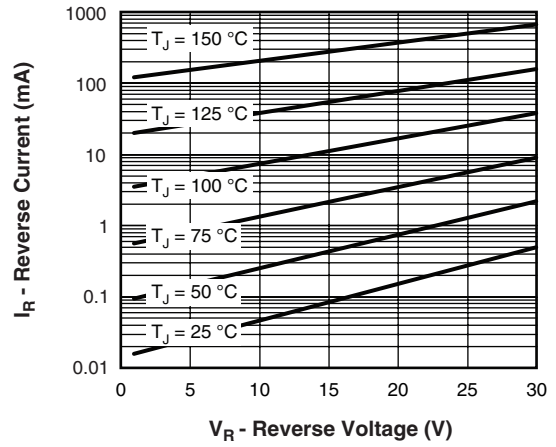

Fig. 2 - Typical Values of Reverse Current vs. Reverse Voltage (Per Leg)

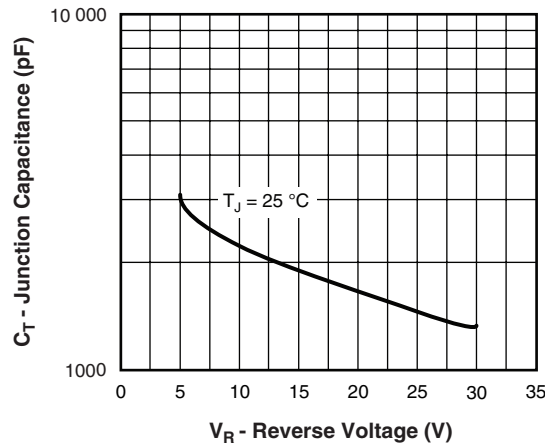

Fig. 3 - Typical Junction Capacitance vs. Reverse Voltage (Per Leg)

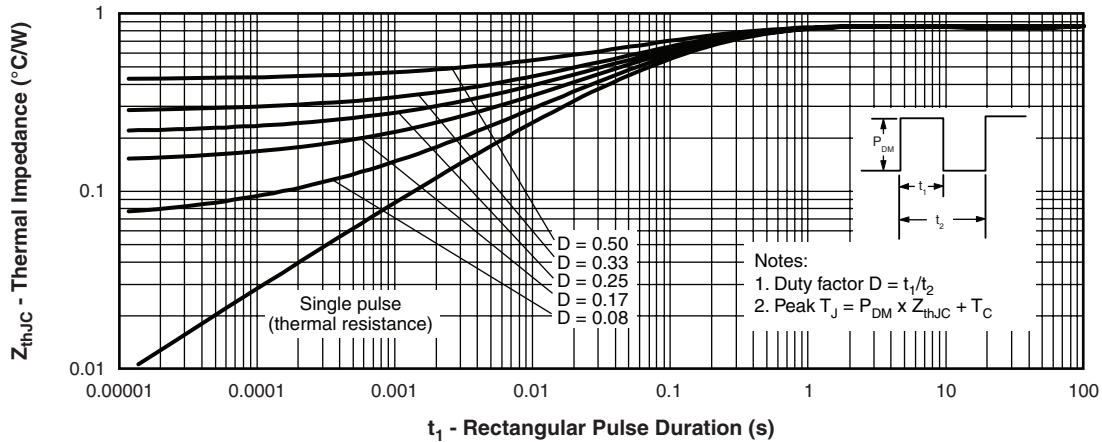

Fig. 4 - Maximum Thermal Impedance  $Z_{thJC}$  Characteristics (Per Leg)

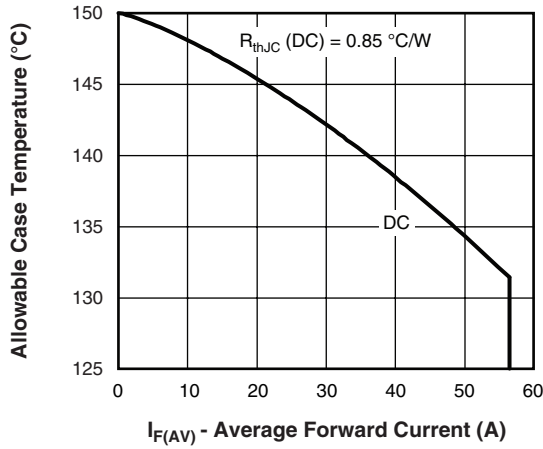

Fig. 5 - Maximum Allowable Case Temperature vs. Average Forward Current (Per Leg)

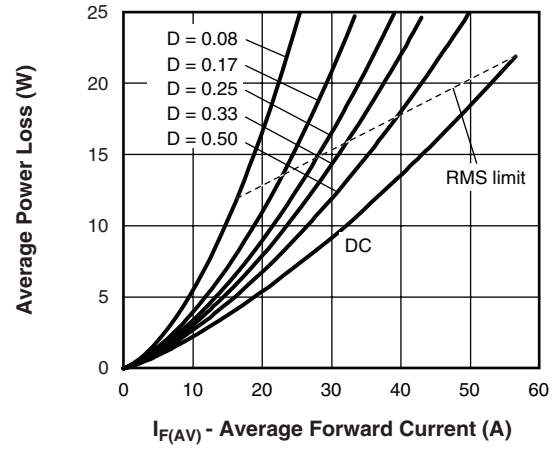

Fig. 6 - Forward Power Loss Characteristics (Per Leg)

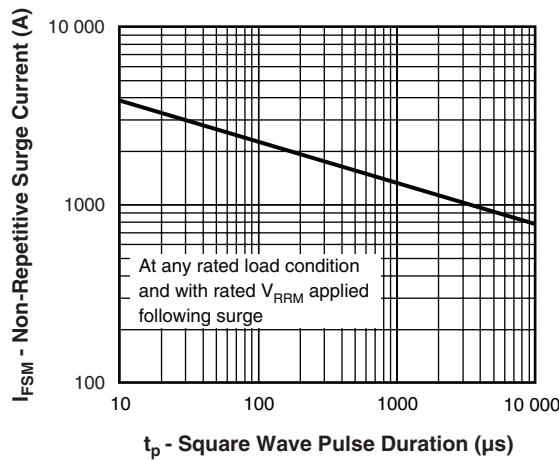

Fig. 7 - Maximum Non-Repetitive Surge Current (Per Leg)

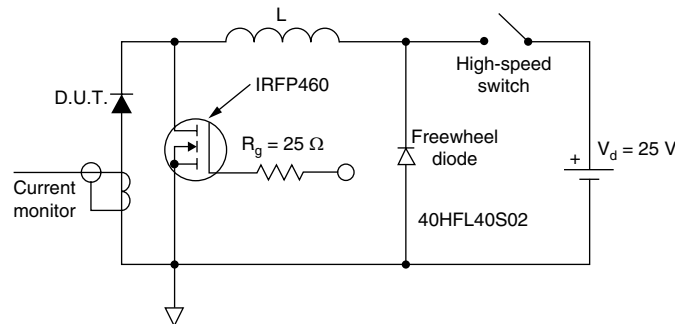

Fig. 8 - Unclamped Inductive Test Circuit



Schottky Rectifier  
New Generation 3  
D-61 Package, 2 x 40 A

Vishay High Power Products

**ORDERING INFORMATION TABLE**

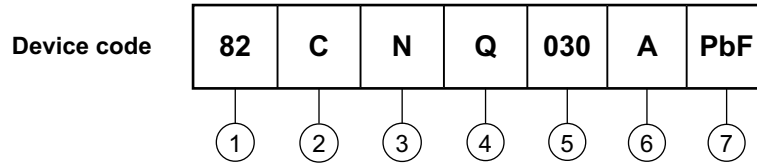

- 1** - Current rating (80 A)
- 2** - Circuit configuration:  
C = Common cathode
- 3** - Package:  
N = D-61
- 4** - Schottky "Q" series
- 5** - Voltage rating (030 = 30 V)
- 6** - A = D-61-8 package style
- 7** -
  - None = Standard production
  - PbF = Lead (Pb)-free

Standard pack quantity: A = 10 pieces

LINKS TO RELATED DOCUMENTS	
Dimensions	<a href="http://www.vishay.com/doc?95019">http://www.vishay.com/doc?95019</a>
Part marking information	<a href="http://www.vishay.com/doc?95030">http://www.vishay.com/doc?95030</a>



## Disclaimer

All product specifications and data are subject to change without notice.

Vishay Intertechnology, Inc., its affiliates, agents, and employees, and all persons acting on its or their behalf (collectively, "Vishay"), disclaim any and all liability for any errors, inaccuracies or incompleteness contained herein or in any other disclosure relating to any product.

Vishay disclaims any and all liability arising out of the use or application of any product described herein or of any information provided herein to the maximum extent permitted by law. The product specifications do not expand or otherwise modify Vishay's terms and conditions of purchase, including but not limited to the warranty expressed therein, which apply to these products.

No license, express or implied, by estoppel or otherwise, to any intellectual property rights is granted by this document or by any conduct of Vishay.

The products shown herein are not designed for use in medical, life-saving, or life-sustaining applications unless otherwise expressly indicated. Customers using or selling Vishay products not expressly indicated for use in such applications do so entirely at their own risk and agree to fully indemnify Vishay for any damages arising or resulting from such use or sale. Please contact authorized Vishay personnel to obtain written terms and conditions regarding products designed for such applications.

Product names and markings noted herein may be trademarks of their respective owners.