

**SCHOTTKY RECTIFIER**  
*New GenIII D-61 Package*

**80 Amp**

$I_{F(AV)} = 80\text{Amp}$   
 $V_R = 80\text{-}100\text{V}$

**Major Ratings and Characteristics**

Characteristics	Values	Units
$I_{F(AV)}$ Rectangular waveform	80	A
$V_{RRM}$ range	80 - 100	V
$I_{FSM}$ @ tp = 5 $\mu$ s sine	5800	A
$V_F$ @ 40 Apk, $T_J = 125^\circ\text{C}$ (per leg)	0.67	V
$T_J$ range	-55 to 175	$^\circ\text{C}$

**Description/ Features**

The 83CNQ...AG center tap Schottky rectifier module series has been optimized for low reverse leakage at high temperature. The proprietary barrier technology allows for reliable operation up to 175  $^\circ\text{C}$  junction temperature. Typical applications are in switching power supplies, converters, free-wheeling diodes, and reverse battery protection.

- 175  $^\circ\text{C}$   $T_J$  operation
- Center tap module
- High purity, high temperature epoxy encapsulation for enhanced mechanical strength and moisture resistance
- Low forward voltage drop
- High frequency operation
- Guard ring for enhanced ruggedness and long term reliability
- *New fully transfer-mold low profile, small footprint, high current package*

**Case Styles**

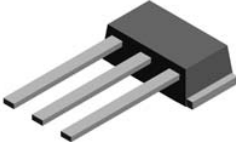
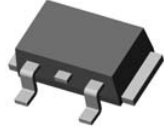
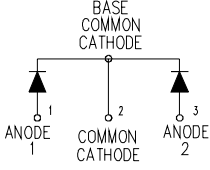
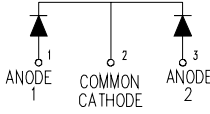
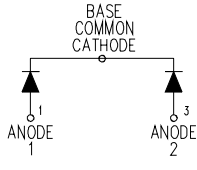
83CNQ...GA	83CNQ...GASM	83CNQ...GASL
		
		
<b>D61-8</b>	<b>D61-8-SM</b>	<b>D61-8-SL</b>

## Voltage Ratings

Part number	83CNQ080GA	83CNQ100GA
$V_R$ Max. DC Reverse Voltage (V)	80	100
$V_{RWM}$ Max. Working Peak Reverse Voltage (V)		

## Absolute Maximum Ratings

Parameters	83CNQ	Units	Conditions
$I_{F(AV)}$ Max. Average Forward Current * See Fig. 5	80	A	50% duty cycle @ $T_C = 132^\circ\text{C}$ , rectangular wave form
$I_{FSM}$ Max. Peak One Cycle Non-Repetitive Surge Current (Per Leg) * See Fig. 7	5800	A	5 $\mu\text{s}$ Sine or 3 $\mu\text{s}$ Rect. pulse 10ms Sine or 6ms Rect. pulse
	600		
$E_{AS}$ Non-Repetitive Avalanche Energy (Per Leg)	15	mJ	$T_J = 25^\circ\text{C}$ , $I_{AS} = 1\text{ Amps}$ , $L = 30\text{ mH}$
$I_{AR}$ Repetitive Avalanche Current (Per Leg)	1	A	Current decaying linearly to zero in 1 $\mu\text{sec}$ Frequency limited by $T_J$ max. $V_A = 1.5 \times V_R$ typical

## Electrical Specifications

Parameters	83CNQ	Units	Conditions
$V_{FM}$ Max. Forward Voltage Drop (Per Leg) * See Fig. 1 (1)	0.81	V	@ 40A $T_J = 25^\circ\text{C}$
	1.00	V	@ 80A
	0.67	V	@ 40A $T_J = 125^\circ\text{C}$
	0.82	V	@ 80A
$I_{RM}$ Max. Reverse Leakage Current (Per Leg) * See Fig. 2 (1)	0.4	mA	$T_J = 25^\circ\text{C}$
	35	mA	$T_J = 125^\circ\text{C}$ $V_R = \text{rated } V_R$
$C_T$ Max. Junction Capacitance (Per Leg)	1400	pF	$V_R = 5V_{DC}$ (test signal range 100Khz to 1Mhz) $25^\circ\text{C}$
$L_S$ Typical Series Inductance (Per Leg)	5.5	nH	Measured lead to lead 5mm from package body
dv/dt Max. Voltage Rate of Change	10000	V/ $\mu\text{s}$	(Rated $V_R$ )

(1) Pulse Width < 300 $\mu\text{s}$ , Duty Cycle <2%

## Thermal-Mechanical Specifications

Parameters	83CNQ	Units	Conditions
$T_J$ Max. Junction Temperature Range	-55 to 175	$^\circ\text{C}$	
$T_{stg}$ Max. Storage Temperature Range	-55 to 175	$^\circ\text{C}$	
$R_{thJC}$ Max. Thermal Resistance Junction to Case (Per Leg)	0.85	$^\circ\text{C/W}$	DC operation * See Fig. 4
$R_{thJC}$ Max. Thermal Resistance Junction to Case (Per Package)	0.42	$^\circ\text{C/W}$	DC operation
$R_{thCS}$ Typical Thermal Resistance, Case to Heatsink (D61-8 Only)	0.30	$^\circ\text{C/W}$	Mounting surface, smooth and greased Device flatness < 5 mils
wt Approximate Weight	7.8 (0.28)	g (oz.)	
T Mounting Torque (D61-8 Only)	Min.	12 (10)	Recommended hardware 3M stainless screw
	Max.	24 (20)	
Device Marking	83CNQ...GA		Case style D61-8
	83CNQ...GASM		Case style D61-8-SM
	83CNQ...GASL		Case style D61-8-SL

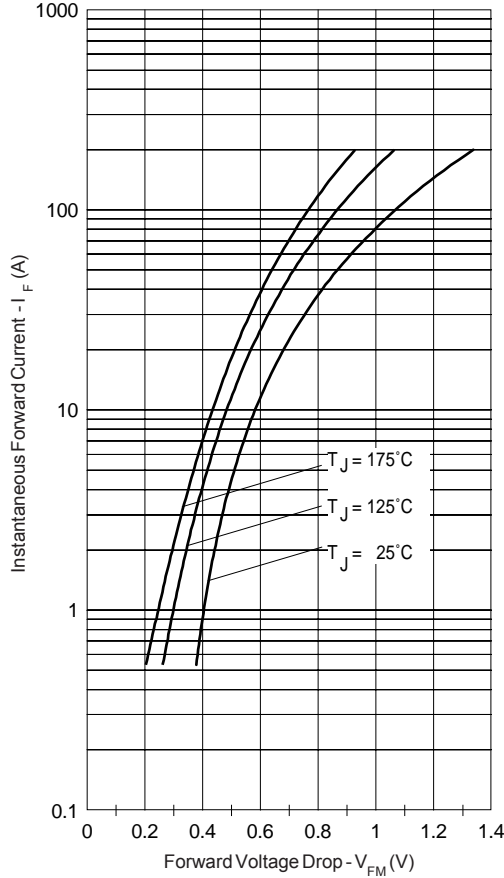

Fig. 1 - Max. Forward Voltage Drop Characteristics (Per Leg)

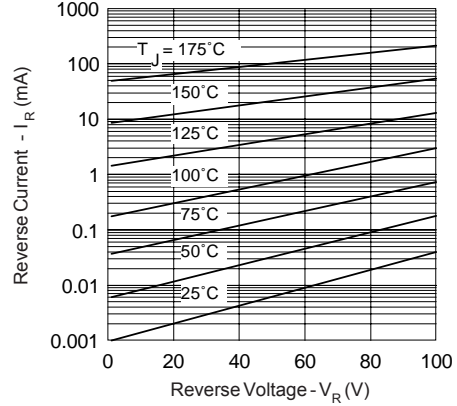

Fig. 2 - Typical Values Of Reverse Current Vs. Reverse Voltage (Per Leg)

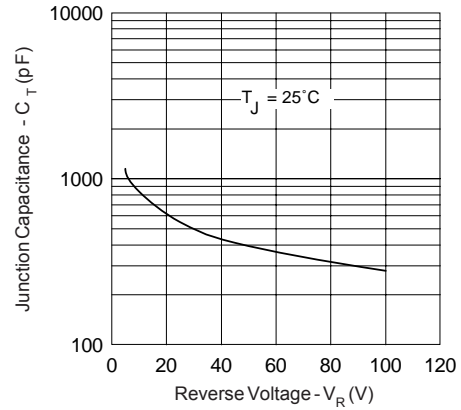

Fig. 3 - Typical Junction Capacitance Vs. Reverse Voltage (Per Leg)

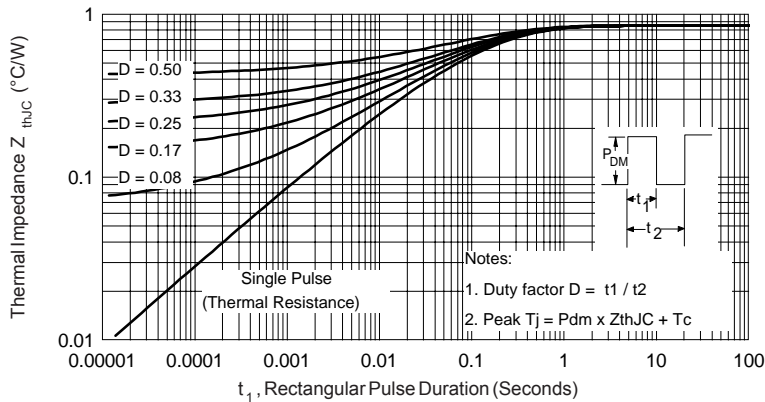

Fig. 4 - Max. Thermal Impedance  $Z_{thJC}$  Characteristics (Per Leg)

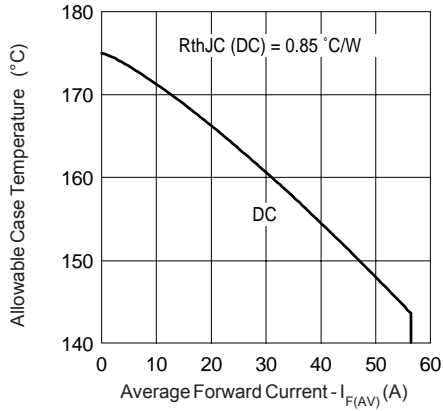

Fig. 5 - Max. Allowable Case Temperature Vs. Average Forward Current (Per Leg)

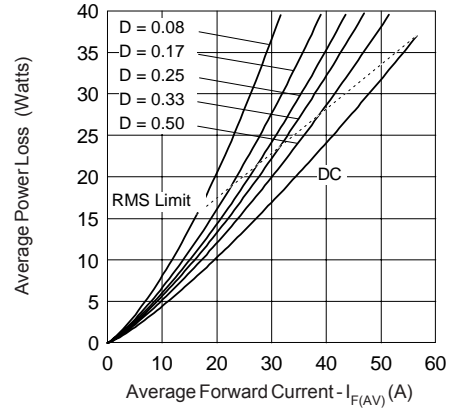

Fig. 6 - Forward Power Loss Characteristics (Per Leg)

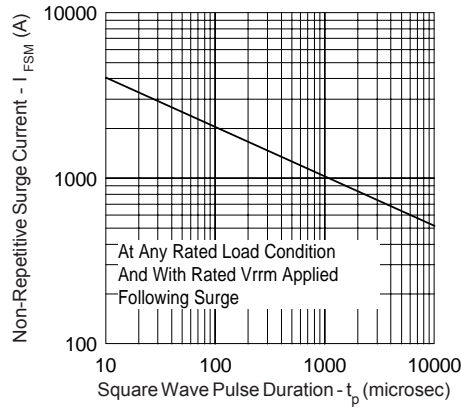

Fig. 7 - Max. Non-Repetitive Surge Current (Per Leg)

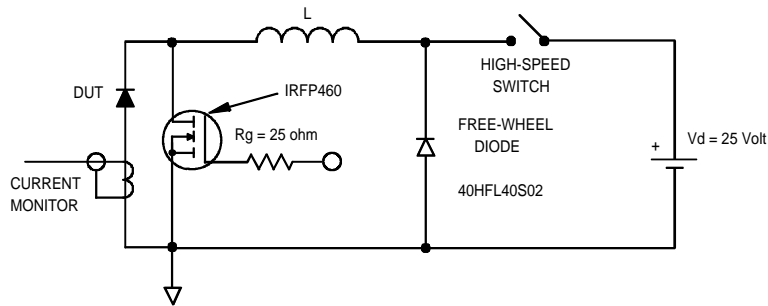
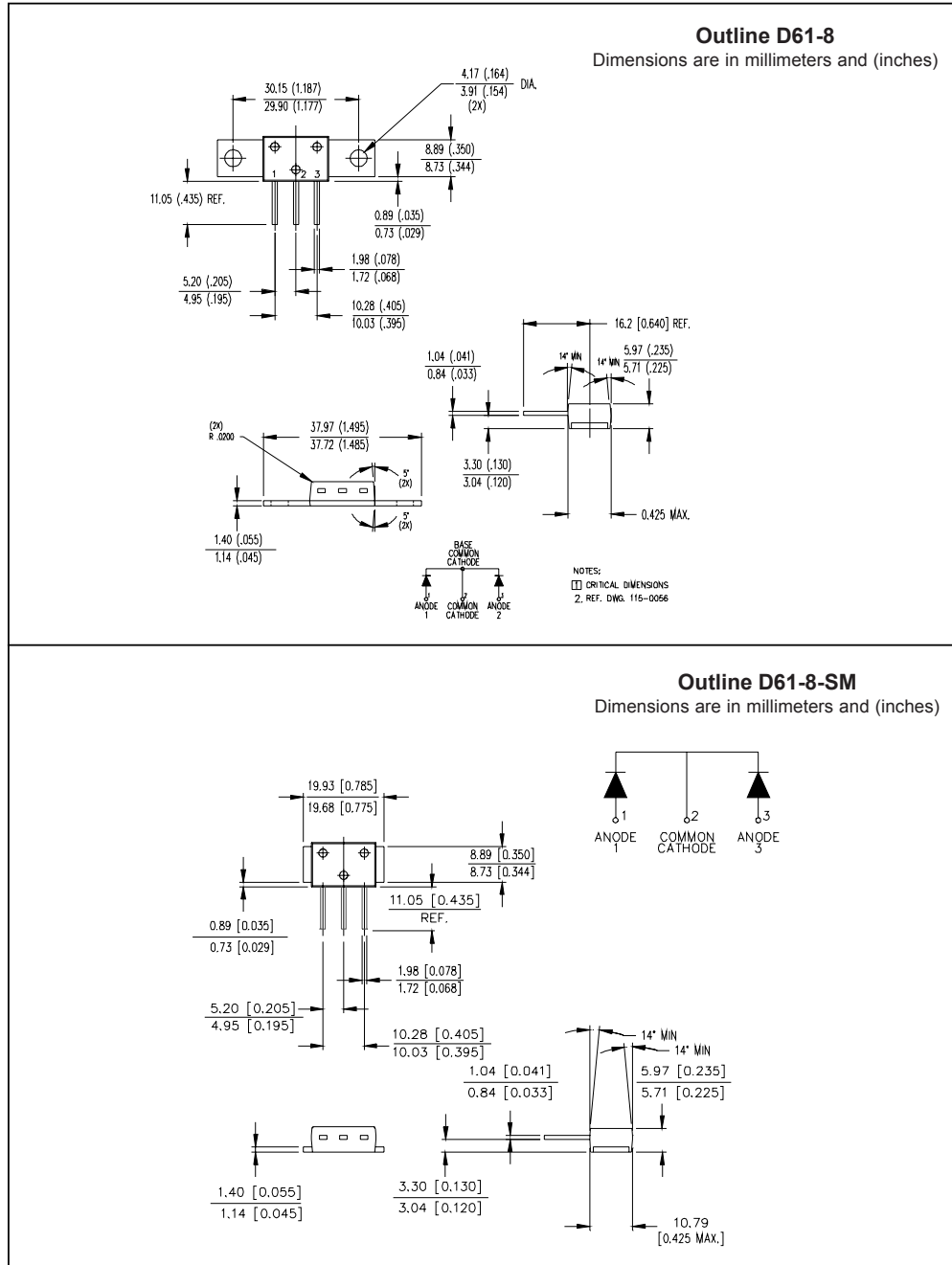

Fig. 8 - Unclamped Inductive Test Circuit

Outline Table



### Outline D61-8-SM

Dimensions are in millimeters and (inches)

Outline Table

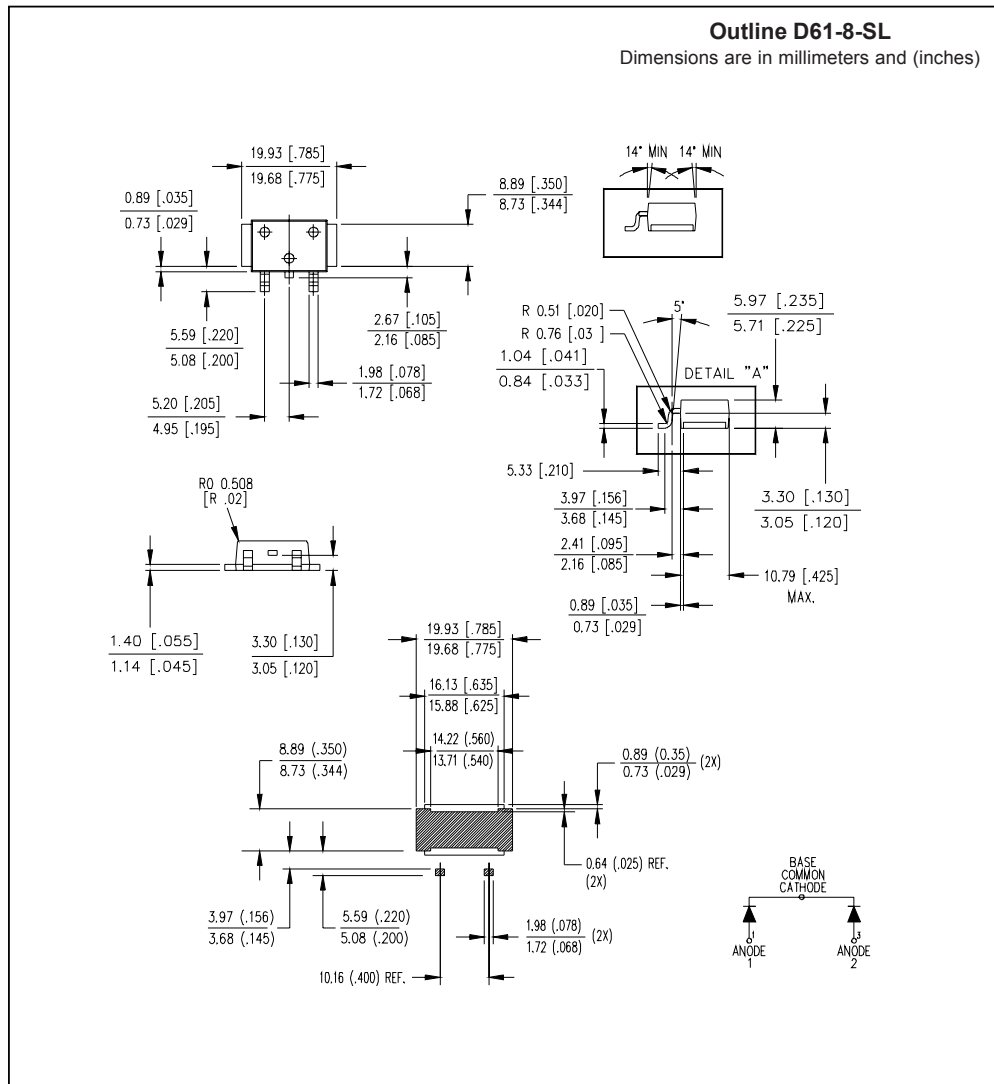

Part Marking Information

EXAMPLE: THIS IS A 83CNQ100GA WITH  
 LOT CODE 89 09  
 ASSEMBLED ON WW 45, 2000  
 IN THE ASSEMBLY LINE "A"

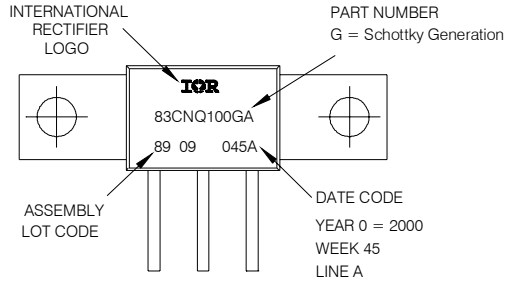

D61-8

EXAMPLE: THIS IS A 83CNQ100GASM WITH  
 LOT CODE 89 09  
 ASSEMBLED ON WW 45, 2000  
 IN THE ASSEMBLY LINE "A"

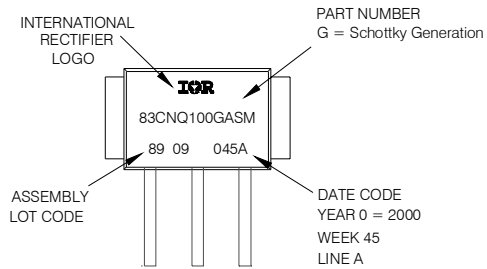

D61-8-SM

EXAMPLE: THIS IS A 83CNQ100GASL WITH  
 LOT CODE 89 09  
 ASSEMBLED ON WW 45, 2000  
 IN THE ASSEMBLY LINE "A"

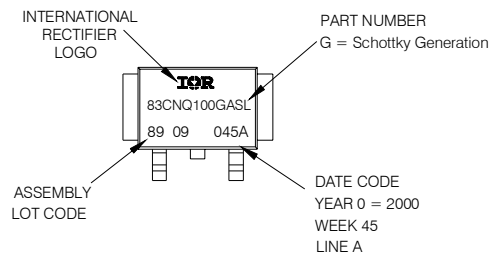

D61-8-SL

83CNQ100A

\*\*\*\*\*

\* This model has been developed by \*  
 \* Wizard SPICE MODEL GENERATOR (1999) \*  
 \* (International Rectifier Corporation) \*  
 \* contains Proprietary Information \*  
 \*\*\*\*\*

\* SPICE Model Diode is composed by a \*  
 \* simple diode plus paraladed VCG2T \*  
 \*\*\*\*\*

.SUBCKT 83CNQ100A ANO CAT

D1 ANO 1 DMOD (0,20831)

\*Define diode model

.MODEL DMOD D(IS=3.91765102575707E-04A,N=1.6412007115037,BV=110V,

+ IBV=1.66611874283115A,RS= 0.001083212,CJO=1.31909764291715E-08,

+ VJ=1.04145964983498,XTI=2, EG=0.757359996913038)

\*\*\*\*\*

\*Implementation of VCG2T

VX 1 2 DC 0V

R1 2 CAT TRES 1E-6

.MODEL TRES RES(R=1,TC1=-5.06642501757023)

GP1 ANO CAT VALUE=(-ABS(I(VX))\*(EXP((((2.558893E-02/-5.066425)\*(V(2,CAT)\*1E6)/(I(VX)+1E-6)-1)))+1)\*3.120336E-03\*ABS(V(ANO,CAT)))-1)}

\*\*\*\*\*

.ENDS 83CNQ100A

Thermal Model Subcircuit

.SUBCKT 83CNQ100A 5 1

CTHERM1 5 4 8.75E-04

CTHERM2 4 3 1.99E+00

CTHERM3 3 2 2.04E+01

CTHERM4 2 1 2.41E+02

R THERM1 5 4 1.00E-07

R THERM2 4 3 4.51E-01

R THERM1 3 2 3.08E-01

R THERM1 2 1 7.27E-02

.ENDS 83CNQ100A



Ordering Information Table

Device Code	83	C	N	Q	100	G	A	-
	1	2	3	4	5	6	7	8
<b>1</b>	-	Current Rating (80A)						
<b>2</b>	-	C = Common Cathode						
<b>3</b>	-	N = Module (Not Isolated)						
<b>4</b>	-	Q = Schottky Q Series						
<b>5</b>	-	Voltage Ratings						080 = 80V 100 = 100V
<b>6</b>	-	G = Schottky Generation						
<b>7</b>	-	• A = D-61-8 (10 pieces) • ASL = D61-8-SL (20 pieces) • ASM = D61-8-SM (20 pieces)						
<b>8</b>	-	• none = Standard Production • PbF = Lead-Free						

Data and specifications subject to change without notice.  
 This product has been designed and qualified for Industrial Level.  
 Qualification Standards can be found on IR's Web site.