

International
IR Rectifier

83CNQ...APbF
 83CNQ...ASMPbF

SCHOTTKY RECTIFIER
 New GenIII D-61 Package

80 Amp

Major Ratings and Characteristics

Characteristics	Values	Units
$I_{F(AV)}$ Rectangular waveform	80	A
V_{RRM} range	80, 100	V
I_{FSM} @ tp = 5 μ s sine	7000	A
V_F @ 40 Apk, $T_J = 125^\circ\text{C}$ (per leg)	0.67	V
T_J range	-55 to 175	$^\circ\text{C}$

Description/ Features

The center tap Schottky rectifier module series has been optimized for low reverse leakage at high temperature. The proprietary barrier technology allows for reliable operation up to 175 $^\circ\text{C}$ junction temperature. Typical applications are in switching power supplies, converters, free-wheeling diodes, and reverse battery protection.

- 175 $^\circ\text{C}$ T_J operation
- Center tap module
- High purity, high temperature epoxy encapsulation for enhanced mechanical strength and moisture resistance
- Low forward voltage drop
- High frequency operation
- Guard ring for enhanced ruggedness and long term reliability
- *New fully transfer-mold low profile, small footprint, high current package*
- Through-hole versions are currently available for use in Lead-Free applications ("PbF" suffix)

Case Styles

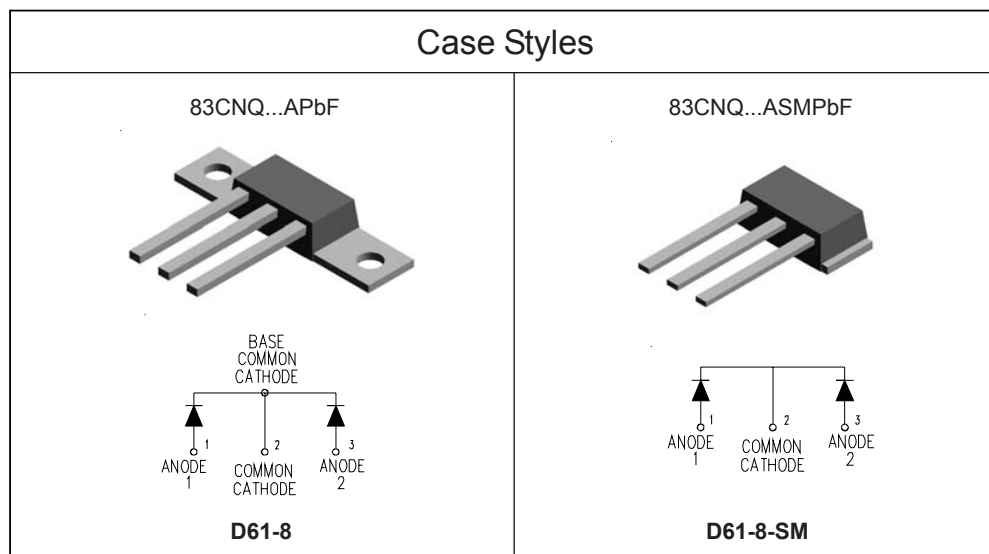

Voltage Ratings

Part number	83CNQ080A..	83CNQ100A..
V_R Max. DC Reverse Voltage (V)	80	100
V_{RWM} Max. Working Peak Reverse Voltage (V)		

Absolute Maximum Ratings

Parameters	83CNQ	Units	Conditions
$I_{F(AV)}$ Max. Average Forward Current * See Fig. 5	80	A	50% duty cycle @ $T_C = 132^\circ\text{C}$, rectangular wave form
I_{FSM} Max. Peak One Cycle Non-Repetitive Surge Current (Per Leg) * See Fig. 7	7000	A	Following any rated load condition and with rated V_{RWM} applied
	720		
E_{AS} Non-Repetitive Avalanche Energy (Per Leg)	15	mJ	$T_J = 25^\circ\text{C}$, $I_{AS} = 1$ Amps, $L = 30$ mH
I_{AR} Repetitive Avalanche Current (Per Leg)	1	A	Current decaying linearly to zero in 1 μsec Frequency limited by T_J max. $V_A = 1.5 \times V_R$ typical

Electrical Specifications

Parameters	83CNQ	Units	Conditions
V_{FM} Max. Forward Voltage Drop (Per Leg) * See Fig. 1 (1)	0.81	V	@ 40A
	1.00	V	@ 80A
	0.67	V	@ 40A
	0.82	V	@ 80A
I_{RM} Max. Reverse Leakage Current (Per Leg) * See Fig. 2 (1)	1.5	mA	$T_J = 25^\circ\text{C}$
	35	mA	$T_J = 125^\circ\text{C}$
C_T Max. Junction Capacitance (Per Leg)	1400	pF	$V_R = 5V_{DC}$, (test signal range 100Khz to 1Mhz) 25°C
L_S Typical Series Inductance (Per Leg)	5.5	nH	Measured lead to lead 5mm from package body
dv/dt Max. Voltage Rate of Change (Rated V_R)	10000	V/ μs	

(1) Pulse Width < 300 μs , Duty Cycle <2%

Thermal-Mechanical Specifications

Parameters	83CNQ	Units	Conditions
T_J Max. Junction Temperature Range	-55 to 175	$^\circ\text{C}$	
T_{stg} Max. Storage Temperature Range	-55 to 175	$^\circ\text{C}$	
R_{thJC} Max. Thermal Resistance Junction to Case (Per Leg)	0.85	$^\circ\text{C/W}$	DC operation * See Fig. 4
R_{thJC} Max. Thermal Resistance Junction to Case (Per Package)	0.42	$^\circ\text{C/W}$	DC operation
R_{thCS} Typical Thermal Resistance, Case to Heatsink (D61-8 Only)	0.30	$^\circ\text{C/W}$	Mounting surface, smooth and greased Device flatness < 5 mils
wt Approximate Weight	7.8 (0.28)	g (oz.)	
T Mounting Torque (D61-8 Only)	Min.	12 (10)	Kg-cm (*) (lbf-in)
	Max.	24 (20)	

(*) Recommended hardware 3M stainless screw

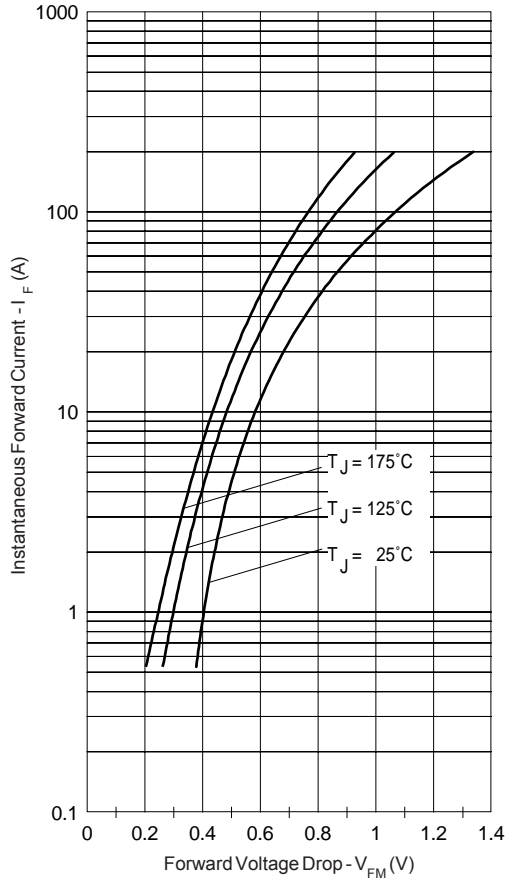

Fig. 1 - Max. Forward Voltage Drop Characteristics (Per Leg)

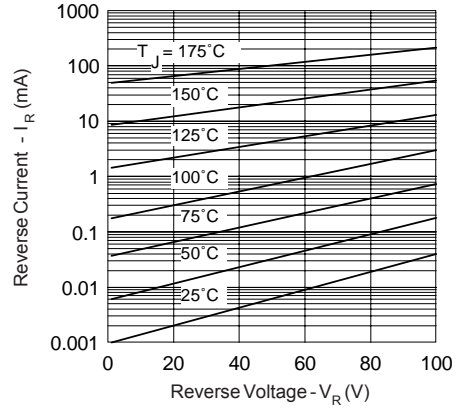

Fig. 2 - Typical Values Of Reverse Current Vs. Reverse Voltage (Per Leg)

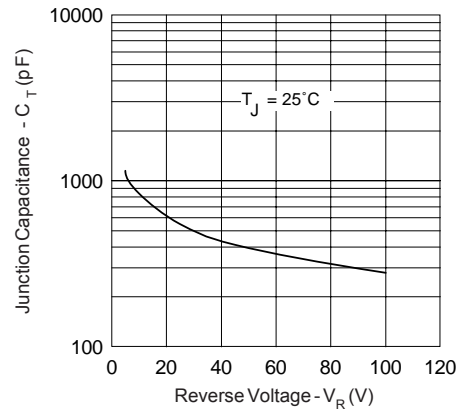

Fig. 3 - Typical Junction Capacitance Vs. Reverse Voltage (Per Leg)

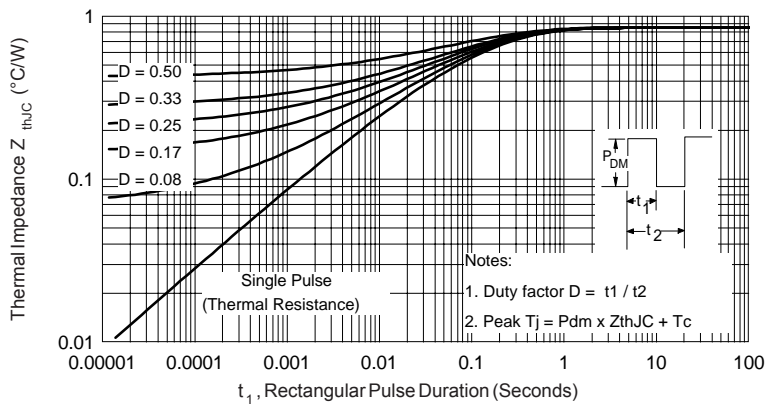

Fig. 4 - Max. Thermal Impedance Z_{thJC} Characteristics (Per Leg)

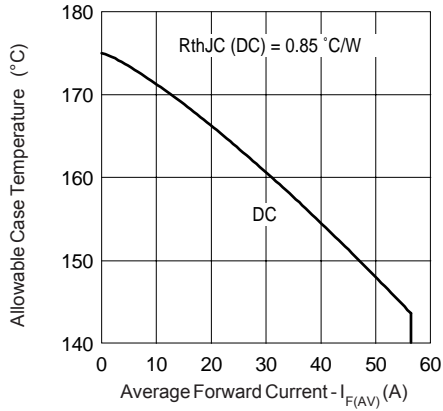

Fig. 5 - Max. Allowable Case Temperature Vs. Average Forward Current (Per Leg)

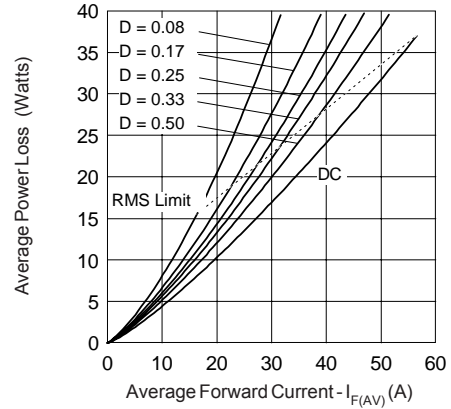

Fig. 6 - Forward Power Loss Characteristics (Per Leg)

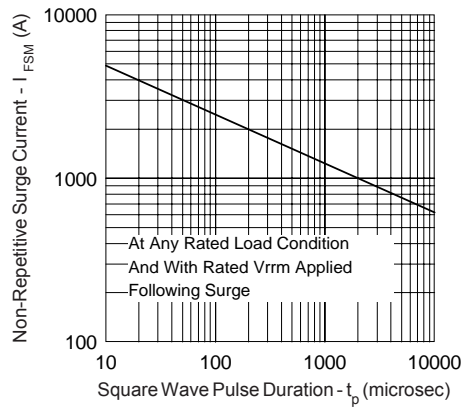

Fig. 7 - Max. Non-Repetitive Surge Current (Per Leg)

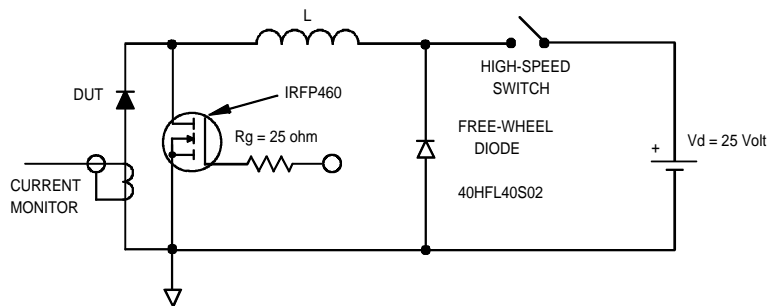
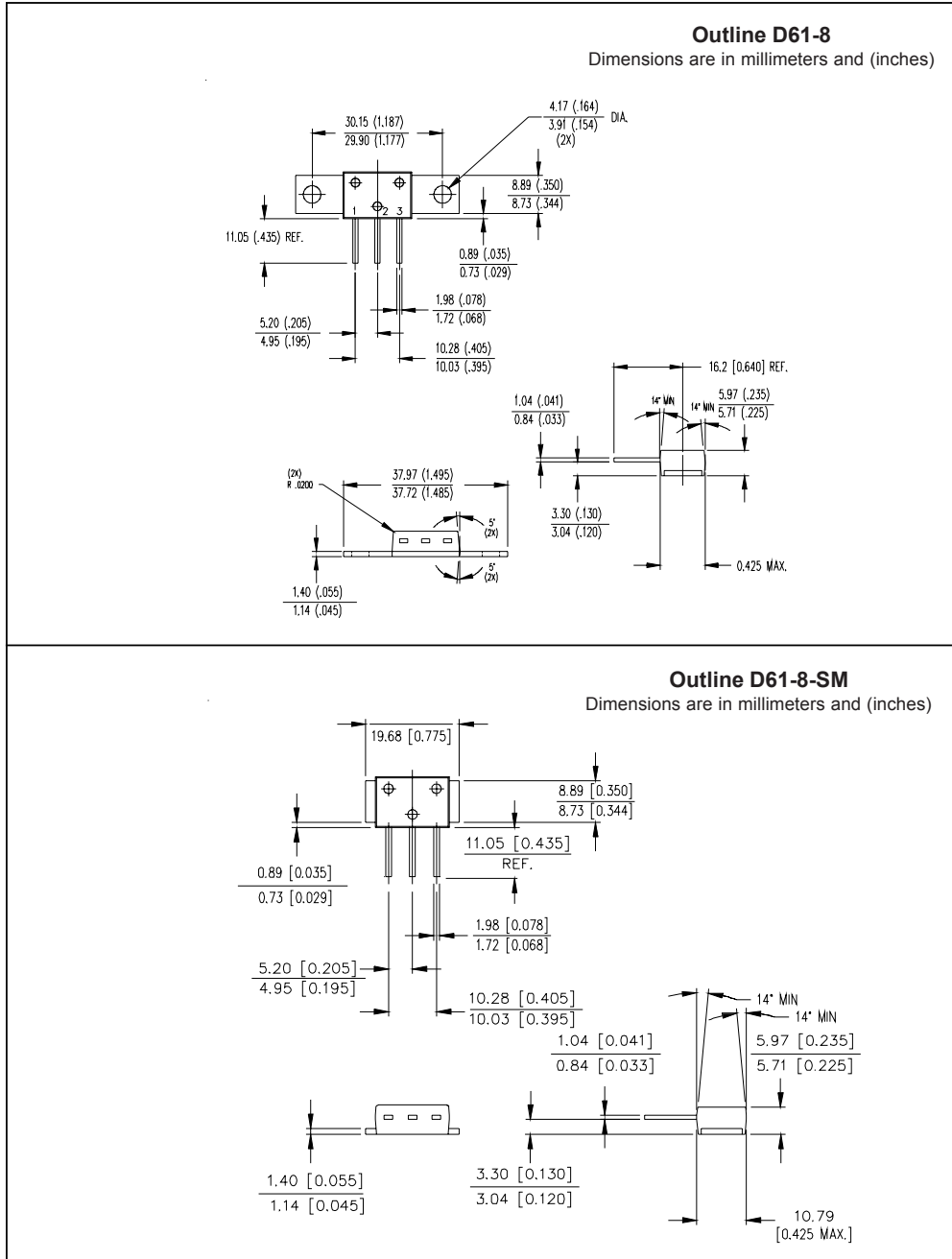

Fig. 8 - Unclamped Inductive Test Circuit

Outline Table



Marking Information

Outline D61-8

EXAMPLE: THIS IS A 83CNQ100 WITH
 LOT CODE 89 09
 ASSEMBLED ON WW 45, 2000

Note: "P" in assembly line
 position indicates "Lead-Free"

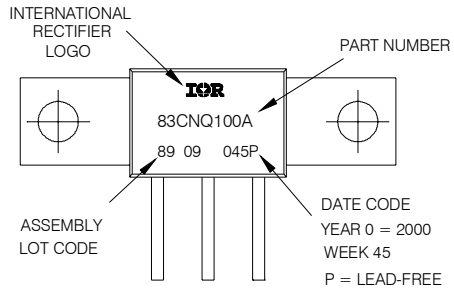

Outline D61-8-SM

EXAMPLE: THIS IS A 83CNQ100ASM WITH
 LOT CODE 89 09
 ASSEMBLED ON WW 45, 2000

Note: "P" in assembly line
 position indicates "Lead-Free"

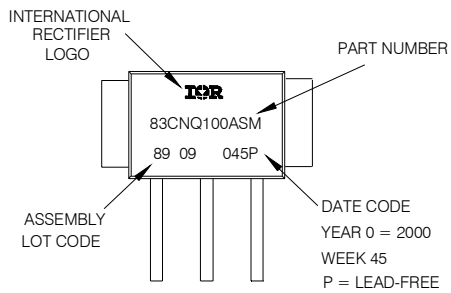

```

83CNQ100A
*****
* This model has been developed by *
* Wizard SPICE MODEL GENERATOR (1999) *
* (International Rectifier Corporation) *
* contains Proprietary Information *
*****
* SPICE Model Diode is composed by a *
* simple diode plus paralld VCG2T *
*****
.SUBCKT 83CNQ100A ANO CAT
D1 ANO 1 DMOD (0.20831)
*Define diode model
.MODEL DMOD D(IS=3.91765102575707E-04A,N=1.6412007115037,BV=110V,
+ IBV=1.66611874283115A,RS= 0.001083212,CJO=1.31909764291715E-08,
+ VJ=1.04145964983498,XTI=2, EG=0.757359996913038)
*****
*Implementation of VCG2T
VX 1 2 DC 0V
R1 2 CAT TRES 1E-6
.MODEL TRES RES(R=1,TC1=-5.06642501757023)
GP1 ANO CAT VALUE={-ABS(I(VX))*EXP((((2.558893E-02/-5.066425)*(V(2,CAT)*1E6)/(I(VX)+1E-6)-
1))+1)*3.120336E-03*ABS(V(ANO,CAT)))-1)}
*****
.ENDS 83CNQ100A

Thermal Model Subcircuit
.SUBCKT 83CNQ100A 5 1

CTHERM1 5 4 8.75E-04
CTHERM2 4 3 1.99E+00
CTHERM3 3 2 2.04E+01
CTHERM4 2 1 2.41E+02

RTHERM1 5 4 1.00E-07
RTHERM2 4 3 4.51E-01
RTHERM1 3 2 3.08E-01
RTHERM1 2 1 7.27E-02

.ENDS 83CNQ100A

```

Ordering Information Table

Device Code						
83	C	N	Q	100	A	PbF
①	②	③	④	⑤	⑥	⑦
1	- Current Rating (80A)					
2	- Circuit Configuration C = Common Cathode					
3	- Package N = D-61					
4	- Schottky "Q" Series					
5	- Voltage Ratings					
6	<ul style="list-style-type: none"> • A = D-61-8 package style • ASM = D-61-8-SM package style 					
7	<ul style="list-style-type: none"> • none = Standard Production • PbF = Lead-Free 					
Standard pack quantity: A = 10 pieces ASM = 20 pieces						

080 = 80V
 100 = 100V

Data and specifications subject to change without notice.
 This product has been designed and qualified for Industrial Level and Lead-Free.
 Qualification Standards can be found on IR's Web site.