



120NQ...(R) SERIES

SCHOTTKY RECTIFIER

120 Amp

$$I_{F(AV)} = 120 \text{ A}$$

$$V_R = 35 \text{ to } 45\text{V}$$

Major Ratings and Characteristics

Characteristics	120NQ..	Units
$I_{F(AV)}$ Rectangular waveform	120	A
V_{RRM} range	35 to 45	V
I_{FSM} @ $t_p = 5 \mu\text{s}$ sine	29,000	A
V_F @ 120Apk, $T_J = 125^\circ\text{C}$	0.52	V
T_J range	-55 to 150	$^\circ\text{C}$

Description/ Features

The 120NQ...(R) high current Schottky rectifier module series has been optimized for very low forward voltage drop, with moderate leakage. The proprietary barrier technology allows for reliable operation up to 150° C junction temperature. Typical applications are in switching power supplies, converters, free-wheeling diodes, and reverse battery protection.

- 150° C T_J operation
- Unique high power, Half-Pak module
- Replaces two parallel DO-5's
- Easier to mount and lower profile than DO-5's
- High purity, high temperature epoxy encapsulation for enhanced mechanical strength and moisture resistance
- Very low forward voltage drop
- High frequency operation
- Guard ring for enhanced ruggedness and long term reliability

Case Styles

120NQ...(R)



D-67

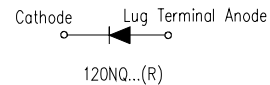
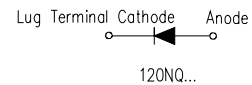

120NQ...(R) Series

Bulletin PD-2.224 rev. D 07/04

International
IR Rectifier

Voltage Ratings

Part number	120NQ035(R)	120NQ040(R)	120NQ045(R)
V_R Max. DC Reverse Voltage (V)	35	40	45
V_{RWM} Max. Working Peak Reverse Voltage (V)			

Absolute Maximum Ratings

Parameters	120NQ	Units	Conditions
$I_{F(AV)}$ Max. Average Forward Current * See Fig. 5	120	A	50% duty cycle @ $T_C = 106^\circ\text{C}$, rectangular wave form
I_{FSM} Max. Peak One Cycle Non-Repetitive Surge Current * See Fig. 7	29,000	A	5 μs Sine or 3 μs Rect. pulse
	1550		10ms Sine or 6ms Rect. pulse
E_{AS} Non-Repetitive Avalanche Energy	81	mJ	$T_J = 25^\circ\text{C}$, $I_{AS} = 12\text{Amps}$, $L = 1.12\text{mH}$
I_{AR} Repetitive Avalanche Current	12	A	Current decaying linearly to zero in 1 μsec Frequency limited by T_J max. $V_A = 1.5 \times V_R$ typical

Electrical Specifications

Parameters	120NQ	Units	Conditions
V_{FM} Max. Forward Voltage Drop (1) * See Fig. 1	0.57	V	@ 120A $T_J = 25^\circ\text{C}$
	0.73	V	@ 240A
	0.52	V	@ 120A $T_J = 125^\circ\text{C}$
	0.69	V	@ 240A
I_{RM} Max. Reverse Leakage Current (1) * See Fig. 2	10	mA	$T_J = 25^\circ\text{C}$
	500	mA	$T_J = 125^\circ\text{C}$ $V_R = \text{rated } V_R$
$V_{F(TO)}$ Threshold Voltage	0.32	V	$T_J = T_J \text{ max.}$
r_t Forward Slope Resistance	1.37	m Ω	
C_T Max. Junction Capacitance	5200	pF	$V_R = 5V_{DC}$, (test signal range 100Khz to 1Mhz) 25°C
L_S Typical Series Inductance	7.0	nH	From top of terminal hole to mounting plane
dv/dt Max. Voltage Rate of Change (Rated V_R)	10000	V/ μs	

Thermal-Mechanical Specifications

(1) Pulse Width < 300 μs , Duty Cycle < 2%

Parameters	120NQ	Units	Conditions	
T_J Max. Junction Temperature Range	-55 to 150	$^\circ\text{C}$		
T_{stg} Max. Storage Temperature Range	-55 to 150	$^\circ\text{C}$		
R_{thJC} Max. Thermal Resistance Junction to Case	0.40	$^\circ\text{C/W}$	DC operation * See Fig. 4	
R_{thCS} Typical Thermal Resistance, Case to Heatsink	0.15	$^\circ\text{C/W}$	Mounting surface, smooth and greased	
wt Approximate Weight	25.6 (0.9)	g (oz.)		
T Mounting Torque	Min.	17 (15)	Non-lubricated threads	
	Max.	29 (25)		
	Terminal Torque	Min.		23 (20)
		Max.		46 (40)
Case Style	HALF PAK Module			

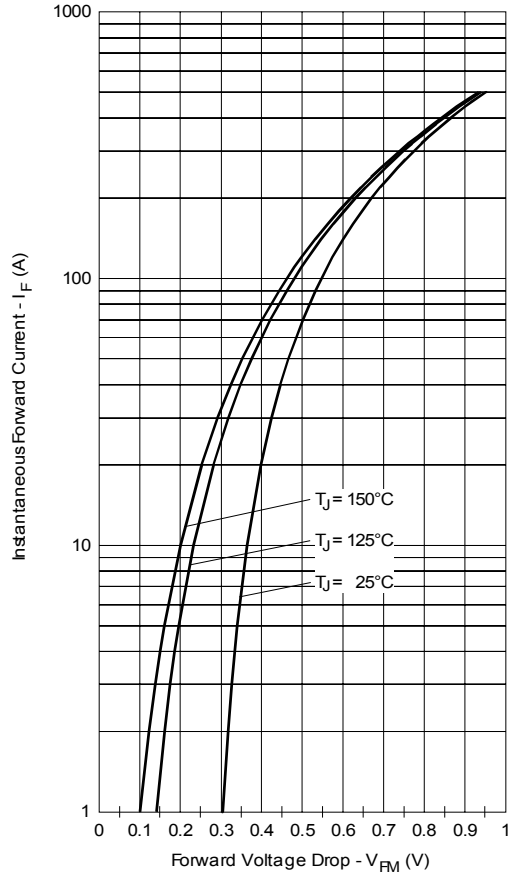

Fig. 1 - Maximum Forward Voltage Drop Characteristics

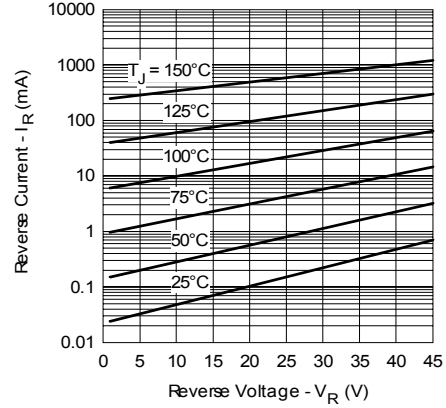

Fig. 2 - Typical Values of Reverse Current Vs. Reverse Voltage

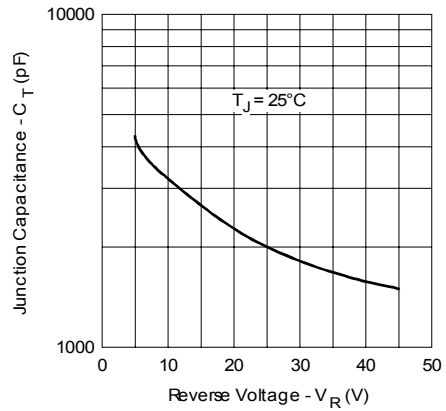

Fig. 3 - Typical Junction Capacitance Vs. Reverse Voltage

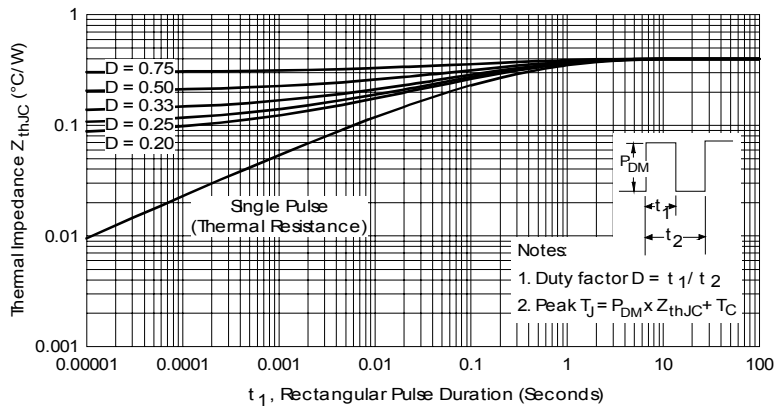

Fig. 4 - Maximum Thermal Impedance Z_{thJC} Characteristics

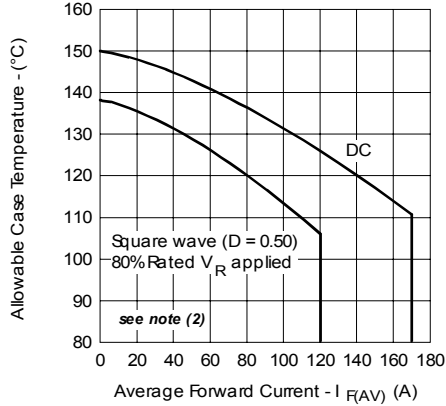

Fig. 5 - Maximum Allowable Case Temperature Vs. Average Forward Current

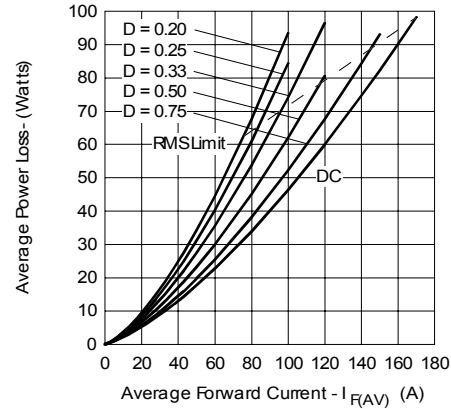

Fig. 6 - Forward Power Loss Characteristics

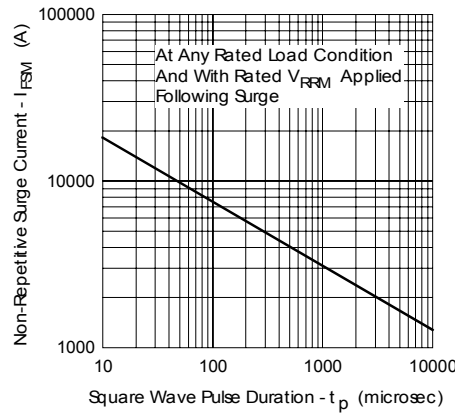

Fig. 7 - Maximum Non-Repetitive Surge Current

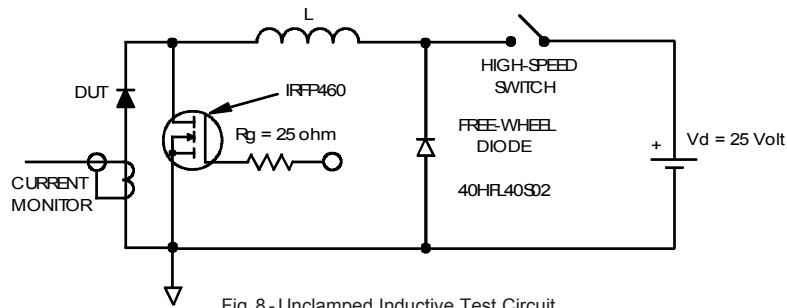
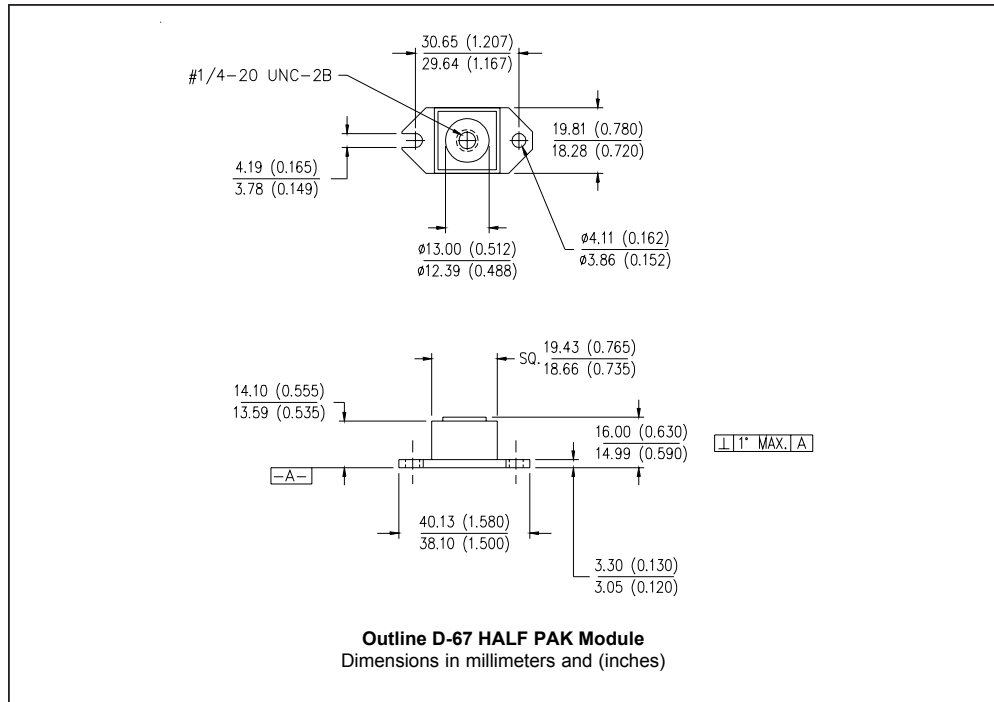

Fig. 8 - Unclamped Inductive Test Circuit

- (2) Formula used: $T_C = T_J - (P_d + P_{d_{REV}}) \times R_{thJC}$;
 $P_d = \text{Forward Power Loss} = I_{F(AV)} \times V_{FM} @ (I_{F(AV)} / D)$ (see Fig. 6);
 $P_{d_{REV}} = \text{Inverse Power Loss} = V_{R1} \times I_{R1} (1 - D)$; $I_{R1} @ V_{R1} = 80\% \text{ rated } V_R$

Outline Table



Data and specifications subject to change without notice.
 This product has been designed and qualified for Industrial Level.
 Qualification Standards can be found on IR's Web site.