

# ZXMN10A08E6

## 100V N-CHANNEL ENHANCEMENT MODE MOSFET

### SUMMARY

$V_{(BR)DSS} = 100V$ ;  $R_{DS(ON)} = 0.4\Omega$   $I_D = 1.5A$

### DESCRIPTION

This new generation of TRENCH MOSFETs from Zetex utilizes a unique structure that combines the benefits of low on-resistance with fast switching speed. This makes them ideal for high efficiency, low voltage, power management applications.

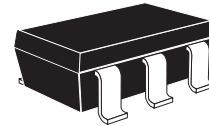

SOT23-6

### FEATURES

- Low on-resistance
- Fast switching speed
- Low threshold
- Low gate drive
- SOT23-6 package

### APPLICATIONS

- DC - DC Converters
- Power Management Functions
- Disconnect switches
- Motor control

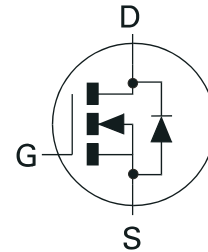

### ORDERING INFORMATION

DEVICE	REEL SIZE	TAPE WIDTH	QUANTITY PER REEL
ZXMN10A08E6TA	7"	8mm	3000 units
ZXMN10A08E6TC	13"	8mm	10000 units

### DEVICE MARKING

- 10A8

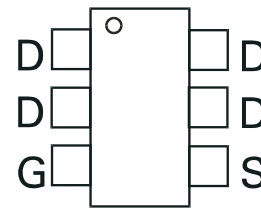

Top View

# ZXMN10A08E6

## ABSOLUTE MAXIMUM RATINGS.

PARAMETER	SYMBOL	LIMIT	UNIT
Drain-Source Voltage	$V_{DSS}$	100	V
Gate Source Voltage	$V_{GS}$	$\pm 20$	V
Continuous Drain Current $V_{GS}=10V$ ; $T_A=25^\circ C$ (b) $V_{GS}=10V$ ; $T_A=70^\circ C$ (b) $V_{GS}=10V$ ; $T_A=25^\circ C$ (a)	$I_D$	1.5 1.2 1.21	A
Pulsed Drain Current (c)	$I_{DM}$	5.3	A
Continuous Source Current (Body Diode) (b)	$I_S$	2.5	A
Pulsed Source Current (Body Diode) (c)	$I_{SM}$	5.3	A
Power Dissipation at $T_A=25^\circ C$ (a) Linear Derating Factor	$P_D$	1.1 8.8	W mW/ $^\circ C$
Power Dissipation at $T_A=25^\circ C$ (b) Linear Derating Factor	$P_D$	1.7 13.6	W mW/ $^\circ C$
Operating and Storage Temperature Range	$T_j:T_{stg}$	-55 to +150	$^\circ C$

## THERMAL RESISTANCE

PARAMETER	SYMBOL	VALUE	UNIT
Junction to Ambient (a)	$R_{\theta JA}$	113	$^\circ C/W$
Junction to Ambient (b)	$R_{\theta JA}$	73	$^\circ C/W$

### NOTES

(a) For a device surface mounted on 25mm x 25mm FR4 PCB with high coverage of single sided 1oz copper, in still air conditions

(b) For a device surface mounted on FR4 PCB measured at  $t \leq 10$  secs.

(c) Repetitive rating 25mm x 25mm FR4 PCB,  $D = 0.05$ , pulse width  $10\mu s$  - pulse width limited by maximum junction temperature. Refer to Transient Thermal Impedance graph



ISSUE 1 - MARCH 2002

# ZXMN10A08E6

## CHARACTERISTICS

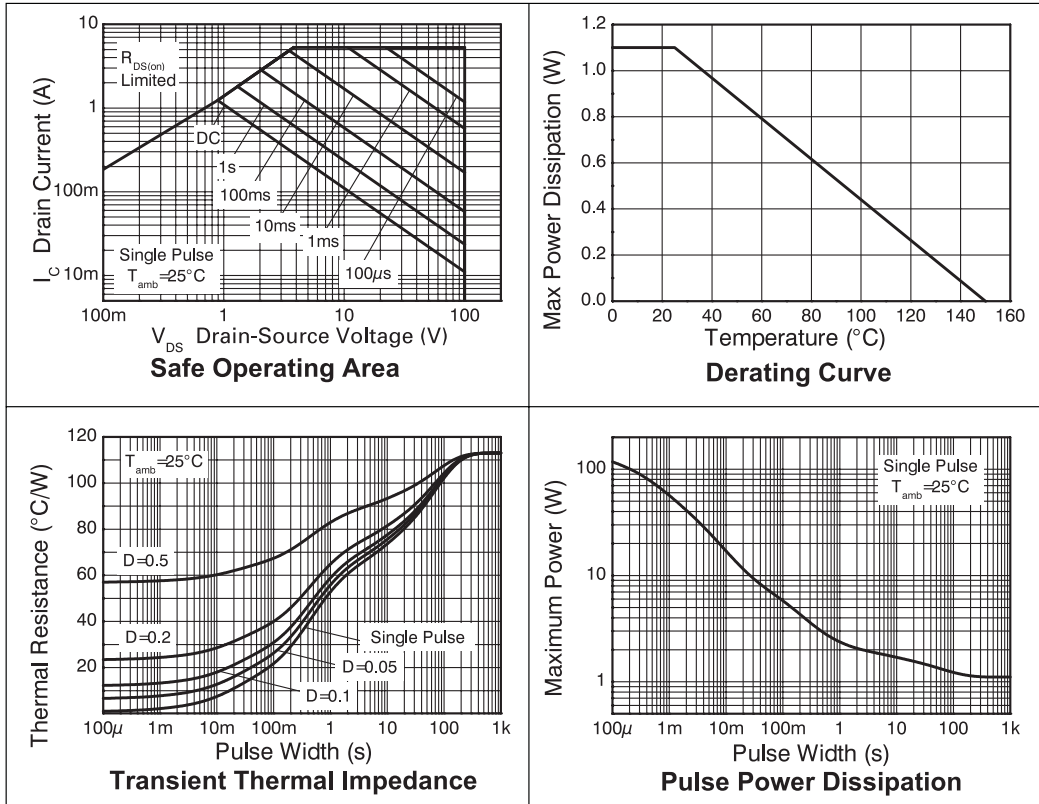

# ZXMN10A08E6

**ELECTRICAL CHARACTERISTICS** (at  $T_A = 25^\circ\text{C}$  unless otherwise stated).

PARAMETER	SYMBOL	MIN.	TYP.	MAX.	UNIT	CONDITIONS.
<b>STATIC</b>						
Drain-Source Breakdown Voltage	$V_{(BR)DSS}$	100			V	$I_D=250\mu\text{A}, V_{GS}=0\text{V}$
Zero Gate Voltage Drain Current	$I_{DSS}$			0.5	$\mu\text{A}$	$V_{DS}=100\text{V}, V_{GS}=0\text{V}$
Gate-Body Leakage	$I_{GSS}$			100	nA	$V_{GS}=\pm 20\text{V}, V_{DS}=0\text{V}$
Gate-Source Threshold Voltage	$V_{GS(th)}$	2.0			V	$I_D=250\mu\text{A}, V_{DS}=V_{GS}$
Static Drain-Source On-State Resistance (1)	$R_{DS(on)}$			0.40 0.60	$\Omega$ $\Omega$	$V_{GS}=10\text{V}, I_D=3.2\text{A}$ $V_{GS}=6\text{V}, I_D=2.6\text{A}$
Forward Transconductance (1)(3)	$g_{fs}$		5.0		S	$V_{DS}=15\text{V}, I_D=3.2\text{A}$
<b>DYNAMIC (3)</b>						
Input Capacitance	$C_{iss}$		405		pF	$V_{DS}=50\text{V}, V_{GS}=0\text{V}, f=1\text{MHz}$
Output Capacitance	$C_{oss}$		28.2		pF	
Reverse Transfer Capacitance	$C_{rss}$		14.2		pF	
<b>SWITCHING(2) (3)</b>						
Turn-On Delay Time	$t_{d(on)}$		3.4		ns	$V_{DD}=30\text{V}, I_D=1.2\text{A}$ $R_G=6.0\Omega, V_{GS}=10\text{V}$
Rise Time	$t_r$		2.2		ns	
Turn-Off Delay Time	$t_{d(off)}$		8		ns	
Fall Time	$t_f$		3.2		ns	
Gate Charge	$Q_g$		4.2		nC	$V_{DS}=50\text{V}, V_{GS}=5\text{V}, I_D=1.2\text{A}$
Total Gate Charge	$Q_g$		7.7		nC	$V_{DS}=50\text{V}, V_{GS}=10\text{V}, I_D=1.2\text{A}$
Gate-Source Charge	$Q_{gs}$		1.8		nC	
Gate-Drain Charge	$Q_{gd}$		2.1		nC	
<b>SOURCE-DRAIN DIODE</b>						
Diode Forward Voltage (1)	$V_{SD}$		0.87	0.95	V	$T_J=25^\circ\text{C}, I_S=3.2\text{A}, V_{GS}=0\text{V}$
Reverse Recovery Time (3)	$t_{rr}$		27		ns	$T_J=25^\circ\text{C}, I_F=1.2\text{A}, di/dt=100\text{A}/\mu\text{s}$
Reverse Recovery Charge (3)	$Q_{rr}$		32		nC	

## NOTES

- (1) Measured under pulsed conditions. Width=300 $\mu\text{s}$ . Duty cycle  $\leq 2\%$ .
- (2) Switching characteristics are independent of operating junction temperature.
- (3) For design aid only, not subject to production testing.



ISSUE 1 - MARCH 2002

# ZXMN10A08E6

## TYPICAL CHARACTERISTICS

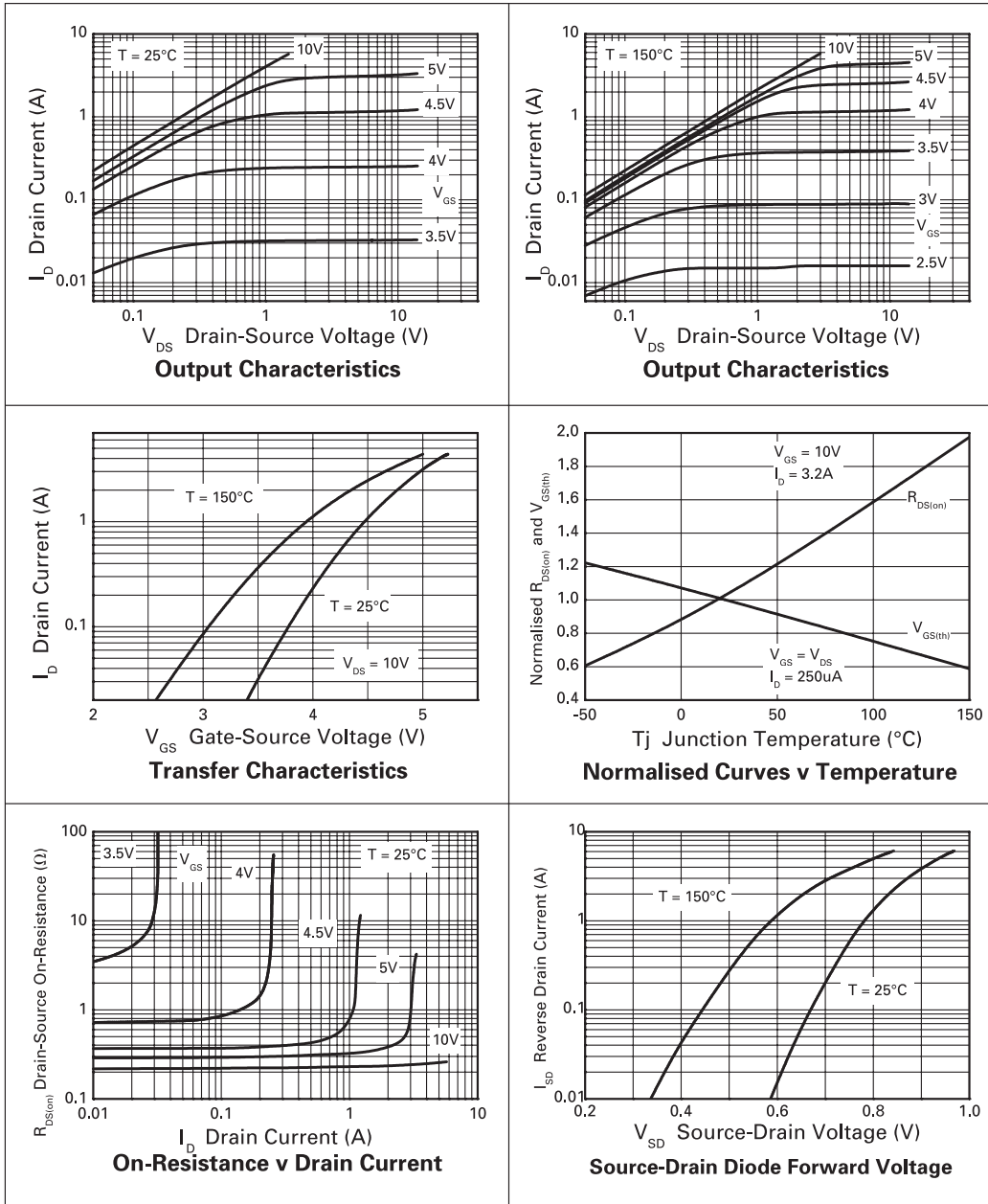

# ZXMN10A08E6

## TYPICAL CHARACTERISTICS

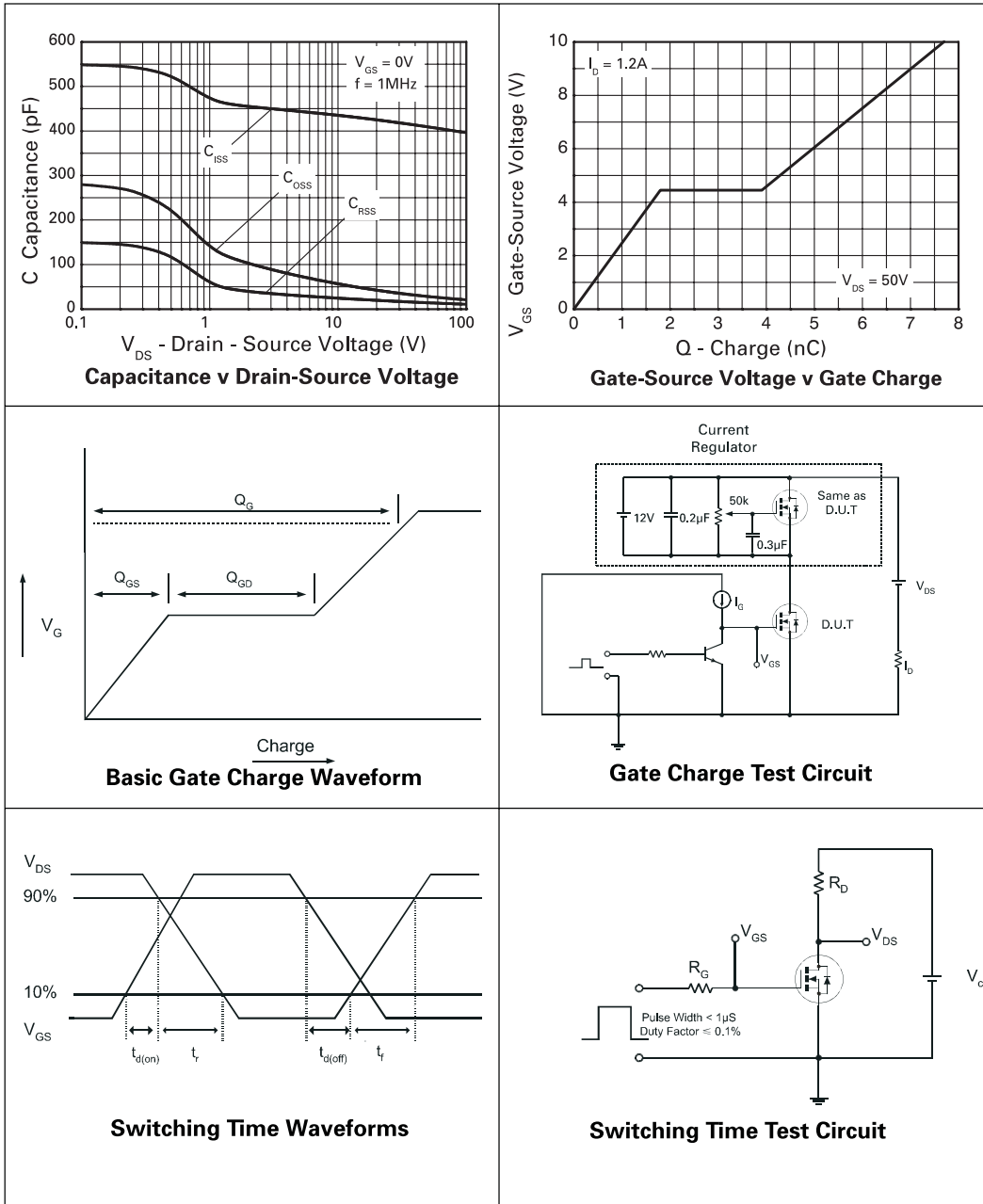

ISSUE 1 - MARCH 2002

# ZXMN10A08E6

## PACKAGE DIMENSIONS

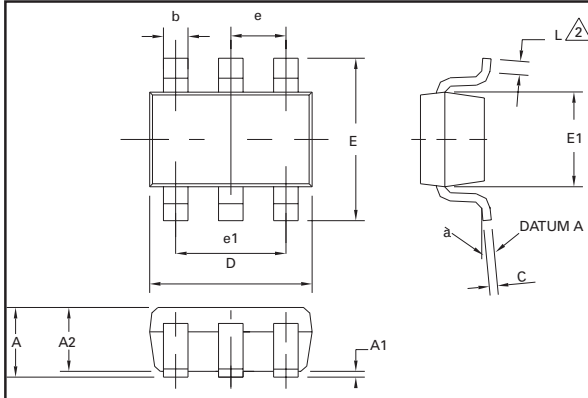

## PAD LAYOUT DETAILS

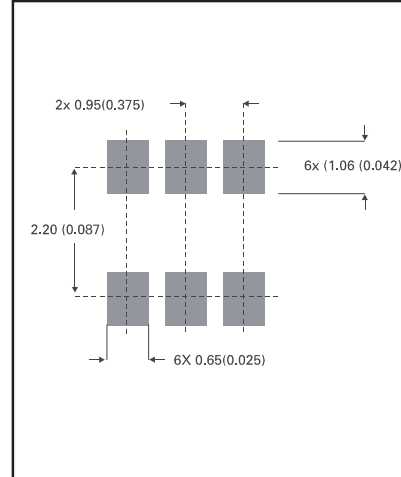

DIM	Millimetres		Inches	
	Min	Max	Min	Max
A	0.90	1.45	0.35	0.057
A1	0.00	0.15	0	0.006
A2	0.90	1.30	0.035	0.051
b	0.35	0.50	0.014	0.019
C	0.09	0.20	0.0035	0.008
D	2.80	3.00	0.110	0.118
E	2.60	3.00	0.102	0.118
E1	1.50	1.75	0.059	0.069
L	0.10	0.60	0.004	0.002
e	0.95 REF		0.037 REF	
e1	1.90 REF		0.074 REF	
L	0°	10°	0°	10°

© Zetex plc 2001

Zetex plc  
Fields New Road  
Chadderton  
Oldham, OL9 8NP  
United Kingdom  
Telephone (44) 161 622 4422  
Fax: (44) 161 622 4420

Zetex GmbH  
Streitfeldstraße 19  
D-81673 München  
Germany  
Telefon: (49) 89 45 49 49 0  
Fax: (49) 89 45 49 49 49

Zetex Inc  
700 Veterans Memorial Hwy  
Hauppauge, NY11788  
USA  
Telephone: (631) 360 2222  
Fax: (631) 360 8222

Zetex (Asia) Ltd  
3701-04 Metroplaza, Tower 1  
Hing Fong Road  
Kwai Fong  
Hong Kong  
Telephone: (852) 26100 611  
Fax: (852) 24250 494

These offices are supported by agents and distributors in major countries world-wide.

This publication is issued to provide outline information only which (unless agreed by the Company in writing) may not be used, applied or reproduced for any purpose or form part of any order or contract or be regarded as a representation relating to the products or services concerned. The Company reserves the right to alter without notice the specification, design, price or conditions of supply of any product or service.

For the latest product information, log on to [www.zetex.com](http://www.zetex.com)

ISSUE 1 - MARCH 2002

ZETEX