

# LM6152/LM6154

## Dual and Quad 75 MHz GBW Rail-to-Rail I/O Operational Amplifiers

### General Description

Using patented circuit topologies, the LM6152/LM6154 provides new levels of speed vs. power performance in applications where low voltage supplies or power limitations previously made compromise necessary. With only 1.4 mA/amplifier supply current, the 75 MHz gain bandwidth of this device supports new portable applications where higher power devices unacceptably drain battery life. The slew rate of the devices increases with increasing input differential voltage, thus allowing the device to handle capacitive loads while maintaining large signal amplitude.

The LM6152/LM6154 can be driven by voltages that exceed both power supply rails, thus eliminating concerns about exceeding the common-mode voltage range. The rail-to-rail output swing capability provides the maximum possible dynamic range at the output. This is particularly important when operating on low supply voltages.

Operating on supplies from 2.7V to over 24V, the LM6152/LM6154 is excellent for a very wide range of applications, from battery operated systems with large bandwidth requirements to high speed instrumentation.

### Features

At  $V_S = 5V$ , typical unless noted.

- Greater than rail-to-rail input CMVR  $-0.25V$  to  $5.25V$
- Rail-to-rail output swing  $0.01V$  to  $4.99V$
- Wide gain-bandwidth  $75\text{ MHz @ }100\text{ kHz}$
- Slew rate
  - Small signal  $5\text{ V}/\mu\text{s}$
  - Large signal  $45\text{ V}/\mu\text{s}$
- Low supply current  $1.4\text{ mA/amplifier}$
- Wide supply range  $2.7V$  to  $24V$
- Fast settling time of  $1.1\ \mu\text{s}$  for  $2V$  step (to  $0.01\%$ )
- PSRR  $91\text{ dB}$
- CMRR  $84\text{ dB}$

### Applications

- Portable high speed instrumentation
- Signal conditioning amplifier/ADC buffers
- Barcode scanners

### Connection Diagrams

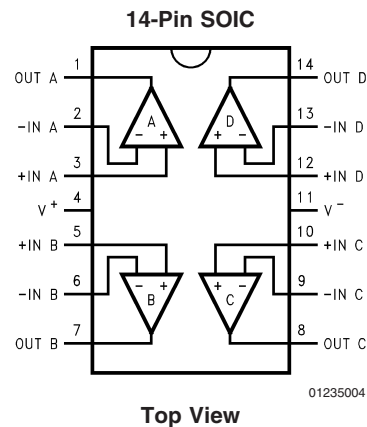
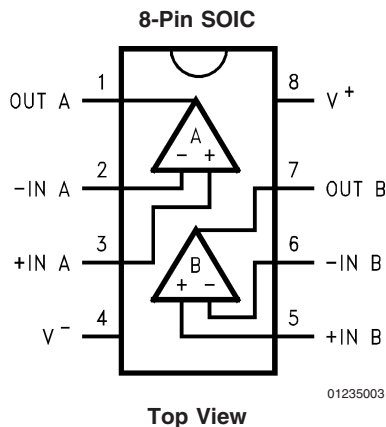

### Ordering Information

Package	Part Number	Package Marking	Transport Media	NSC Drawing
8-Pin SOIC	LM6152ACM	LM6152ACM	95 Units/Rails	M08A
	LM6152ACMX		2.5k Units Tape and Reel	
	LM6152BCM	LM6152BCM	95 Units/Rails	
	LM6152BCMX		2.5k Units Tape and Reel	
14-Pin SOIC	LM6154BCM	LM6154BCM	55 Units/Rails	M14A
	LM6154BCMX		2.5k Units Tape and Reel	

**Absolute Maximum Ratings** (Note 1)

If Military/Aerospace specified devices are required, please contact the National Semiconductor Sales Office/Distributors for availability and specifications.

ESD Tolerance (Note 2)	2500V
Differential Input Voltage	15V
Voltage at Input/Output Pin	(V <sup>+</sup> ) + 0.3V, (V <sup>-</sup> ) -0.3V
Supply Voltage (V <sup>+</sup> - V <sup>-</sup> )	35V
Current at Input Pin	±10 mA
Current at Output Pin (Note 3)	±25 mA
Current at Power Supply Pin	50 mA
Lead Temperature (soldering, 10 sec)	260°C

Storage Temperature Range -65°C to +150°C

Junction Temperature (Note 4) 150°C

**Operating Ratings** (Note 1)

Supply Voltage	2.7V ≤ V <sup>+</sup> ≤ 24V
Junction Temperature Range	0°C ≤ T <sub>J</sub> ≤ +70°C
LM6152, LM6154	
Thermal Resistance (θ <sub>JA</sub> )	
8-pin SOIC	193°C/W
14-pin SOIC	126°C/W

**5.0V DC Electrical Characteristics**

Unless otherwise specified, all limits are guaranteed for T<sub>J</sub> = 25°C, V<sup>+</sup> = 5.0V, V<sup>-</sup> = 0V, V<sub>CM</sub> = V<sub>O</sub> = V<sup>+</sup>/2 and R<sub>L</sub> > 1 MΩ to V<sup>+</sup>/2. **Boldface** limits apply at the temperature extremes.

Symbol	Parameter	Conditions	Typ (Note 5)	LM6154AC	LM6154BC	Units
				LM6152AC Limit (Note 6)	LM6152BC Limit (Note 6)	
V <sub>OS</sub>	Input Offset Voltage		0.54	2 4	5 7	mV max
TCV <sub>OS</sub>	Input Offset Voltage Average Drift		10			μV/°C
I <sub>B</sub>	Input Bias Current	0V ≤ V <sub>CM</sub> ≤ 5V	500 750	980 1500	980 1500	nA max
I <sub>OS</sub>	Input Offset Current		32 40	100 160	100 160	nA max
R <sub>IN</sub>	Input Resistance, CM	0V ≤ V <sub>CM</sub> ≤ 4V	30			MΩ
CMRR	Common Mode Rejection Ratio	0V ≤ V <sub>CM</sub> ≤ 4V	94	70	70	dB
		0V ≤ V <sub>CM</sub> ≤ 5V	84	60	60	min
PSRR	Power Supply Rejection Ratio	5V ≤ V <sup>+</sup> ≤ 24V	91	80	80	dB min
V <sub>CM</sub>	Input Common-Mode Voltage Range	Low	-0.25	0	0	V
		High	5.25	5.0	5.0	V
A <sub>V</sub>	Large Signal Voltage Gain	R <sub>L</sub> = 10 kΩ	214	50	50	V/mV min
V <sub>O</sub>	Output Swing	R <sub>L</sub> = 100 kΩ	0.006	0.02 0.03	0.02 0.03	V max
			4.992	4.97 4.96	4.97 4.96	V min
		R <sub>L</sub> = 2 kΩ	0.04	0.10 0.12	0.10 0.12	V max
			4.89	4.80 4.70	4.80 4.70	V min
I <sub>SC</sub>	Output Short Circuit Current	Sourcing	6.2	3 2.5	3 2.5	mA min
				27 17	27 17	mA max
		Sinking	16.9	7 5	7 5	mA min
				40	40	mA max

## 5.0V DC Electrical Characteristics (Continued)

Unless otherwise specified, all limits are guaranteed for  $T_J = 25^\circ\text{C}$ ,  $V^+ = 5.0\text{V}$ ,  $V^- = 0\text{V}$ ,  $V_{\text{CM}} = V_O = V^+/2$  and  $R_L > 1\text{M}\Omega$  to  $V^+/2$ . **Boldface** limits apply at the temperature extremes.

Symbol	Parameter	Conditions	Typ (Note 5)	LM6154AC LM6152AC Limit (Note 6)	LM6154BC LM6152BC Limit (Note 6)	Units
$I_S$	Supply Current	Per Amplifier	1.4	2 <b>2.25</b>	2 <b>2.25</b>	mA max

## 5.0V AC Electrical Characteristics

Unless otherwise specified, all limits guaranteed for  $T_J = 25^\circ\text{C}$ ,  $V^+ = 5.0\text{V}$ ,  $V^- = 0\text{V}$ ,  $V_{\text{CM}} = V_O = V^+/2$  and  $R_L > 1\text{M}\Omega$  to  $V^+/2$ . **Boldface** limits apply at the temperature extremes.

Symbol	Parameter	Conditions	Typ (Note 5)	LM6154AC LM6152AC Limit (Note 6)	LM6154BC LM6152BC Limit (Note 6)	Units
SR	Slew Rate	$\pm 4\text{V Step @ } V_S = \pm 6\text{V}$ , $R_S < 1\text{ k}\Omega$	30	24 <b>15</b>	24 <b>15</b>	V/ $\mu\text{s}$ min
GBW	Gain-Bandwidth Product	$f = 100\text{ kHz}$	75			MHz
	Amp-to-Amp Isolation	$R_L = 10\text{ k}\Omega$	125			dB
$e_n$	Input-Referred Voltage Noise	$f = 1\text{ kHz}$	9			nV/ $\sqrt{\text{Hz}}$
$i_n$	Input-Referred Current Noise	$f = 1\text{ kHz}$	0.34			pA/ $\sqrt{\text{Hz}}$
T.H.D	Total Harmonic Distortion	$f = 100\text{ kHz}$ , $R_L = 10\text{ k}\Omega$ $A_V = -1$ , $V_O = 2.5\text{ V}_{\text{PP}}$	-65			dBc
$t_s$	Settling Time	2V Step to 0.01%	1.1			$\mu\text{s}$

## 2.7V DC Electrical Characteristics

Unless otherwise specified, all limits are guaranteed for  $T_J = 25^\circ\text{C}$ ,  $V^+ = 2.7\text{V}$ ,  $V^- = 0\text{V}$ ,  $V_{\text{CM}} = V_O = V^+/2$  and  $R_L > 1\text{M}\Omega$  to  $V^+/2$ . **Boldface** limits apply at the temperature extremes.

Symbol	Parameter	Conditions	Typ (Note 5)	LM6154AC LM6152AC Limit (Note 6)	LM6154BC LM6152BC Limit (Note 6)	Units
$V_{\text{OS}}$	Input Offset Voltage		0.8	2 <b>5</b>	5 <b>8</b>	mV max
$\text{TCV}_{\text{OS}}$	Input Offset Voltage Average Drift		<b>10</b>			$\mu\text{V}/^\circ\text{C}$
$I_B$	Input Bias Current		500			nA
$I_{\text{OS}}$	Input Offset Current		50			nA
$R_{\text{IN}}$	Input Resistance, CM	$0\text{V} \leq V_{\text{CM}} \leq 1.8\text{V}$	30			$\text{M}\Omega$
CMRR	Common Mode Rejection Ratio	$0\text{V} \leq V_{\text{CM}} \leq 1.8\text{V}$	88			dB
		$0\text{V} \leq V_{\text{CM}} \leq 2.7\text{V}$	78			
PSRR	Power Supply Rejection Ratio	$3\text{V} \leq V^+ \leq 5\text{V}$	69			dB
$V_{\text{CM}}$	Input Common-Mode Voltage Range	Low	-0.25	0	0	V
		High	2.95	2.7	2.7	V
$A_V$	Large Signal Voltage Gain	$R_L = 10\text{ k}\Omega$	5.5			V/mV
$V_O$	Output Swing	$R_L = 10\text{ k}\Omega$	0.032	0.07 <b>0.11</b>	0.07 <b>0.11</b>	V max
			2.68	2.64	2.64	V
				<b>2.62</b>	<b>2.62</b>	min
$I_S$	Supply Current	Per Amplifier	1.35			mA

## 2.7V AC Electrical Characteristics

Unless otherwise specified, all limits are guaranteed for  $T_J = 25^\circ\text{C}$ ,  $V^+ = 2.7\text{V}$ ,  $V^- = 0\text{V}$ ,  $V_{\text{CM}} = V_O = V^+/2$  and  $R_L > 1\text{M}\Omega$  to  $V^+/2$ . **Boldface** limits apply at the temperature extremes.

Symbol	Parameter	Conditions	Typ (Note 5)	LM6154AC LM6152AC Limit (Note 6)	LM6154BC LM6152BC Limit (Note 6)	Units
GBW	Gain-Bandwidth Product	$f = 100\text{ kHz}$	80			MHz

## 24V DC Electrical Characteristics

Unless otherwise specified, all limits are guaranteed for  $T_J = 25^\circ\text{C}$ ,  $V^+ = 24\text{V}$ ,  $V^- = 0\text{V}$ ,  $V_{\text{CM}} = V_O = V^+/2$  and  $R_L > 1\text{M}\Omega$  to  $V^+/2$ . **Boldface** limits apply at the temperature extremes.

Symbol	Parameter	Conditions	Typ (Note 5)	LM6154AC LM6152AC Limit (Note 6)	LM6154BC LM6152BC Limit (Note 6)	Units
$V_{\text{OS}}$	Input Offset Voltage		0.3	2 4	7 9	mV max
$\text{TCV}_{\text{OS}}$	Input Offset Voltage Average Drift		10			$\mu\text{V}/^\circ\text{C}$
$I_{\text{B}}$	Input Bias Current		500			nA
$I_{\text{OS}}$	Input Offset Current		32			nA
$R_{\text{IN}}$	Input Resistance, CM	$0\text{V} \leq V_{\text{CM}} \leq 23\text{V}$	60			Meg $\Omega$
CMRR	Common Mode Rejection Ratio	$0\text{V} \leq V_{\text{CM}} \leq 23\text{V}$	94			dB
		$0\text{V} \leq V_{\text{CM}} \leq 24\text{V}$	84			
PSRR	Power Supply Rejection Ratio	$0\text{V} \leq V_{\text{CM}} \leq 24\text{V}$	95			dB
$V_{\text{CM}}$	Input Common-Mode Voltage Range	Low	-0.25	0	0	V
		High	24.25	24	24	V
$A_V$	Large Signal Voltage Gain	$R_L = 10\text{ k}\Omega$	55			V/mV
$V_O$	Output Swing	$R_L = 10\text{ k}\Omega$	0.044	0.075 <b>0.090</b>	0.075 <b>0.090</b>	V max
			23.91	23.8 <b>23.7</b>	23.8 <b>23.7</b>	V min
$I_{\text{S}}$	Supply Current	Per Amplifier	1.6	2.25 <b>2.50</b>	2.25 <b>2.50</b>	mA max

## 24V AC Electrical Characteristics

Unless otherwise specified, all limits are guaranteed for  $T_J = 25^\circ\text{C}$ ,  $V^+ = 24\text{V}$ ,  $V^- = 0\text{V}$ ,  $V_{\text{CM}} = V_O = V^+/2$  and  $R_L > 1\text{M}\Omega$  to  $V^+/2$ . **Boldface** limits apply at the temperature extremes.

Symbol	Parameter	Conditions	Typ (Note 5)	LM6154AC LM6152AC Limit (Note 6)	LM6154BC LM6152BC Limit (Note 6)	Units
GBW	Gain-Bandwidth Product	$f = 100\text{ kHz}$	80			MHz

**Note 1:** Absolute Maximum Ratings indicate limits beyond which damage to the device may occur. Operating Ratings indicate conditions for which the device is intended to be functional, but specific performance is not guaranteed. For guaranteed specifications and the test conditions, see the Electrical Characteristics.

**Note 2:** Human body model is 1.5 k $\Omega$  in series with 100 pF.

**Note 3:** Applies to both single-supply and split-supply operation. Continuous short circuit operation at elevated ambient temperature can result in exceeding the maximum allowed junction temperature of 150°C.

**Note 4:** The maximum power dissipation is a function of  $T_{\text{J(MAX)}}$ ,  $\theta_{\text{JA}}$ , and  $T_{\text{A}}$ . The maximum allowable power dissipation at any ambient temperature is  $P_{\text{D}} = (T_{\text{J(MAX)}} - T_{\text{A}}) / \theta_{\text{JA}}$ . All numbers apply for packages soldered directly into a PC board.

**Note 5:** Typical Values represent the most likely parametric norm.

**Note 6:** All limits are guaranteed by testing or statistical analysis.

# Typical Performance Characteristics

Supply Current vs. Supply Voltage

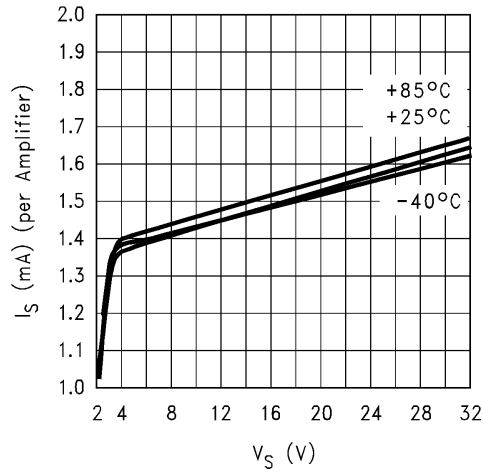

Offset Voltage vs. Supply voltage

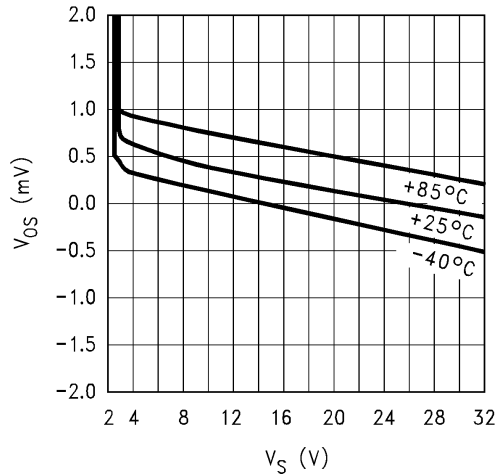

Bias Current vs. Supply voltage

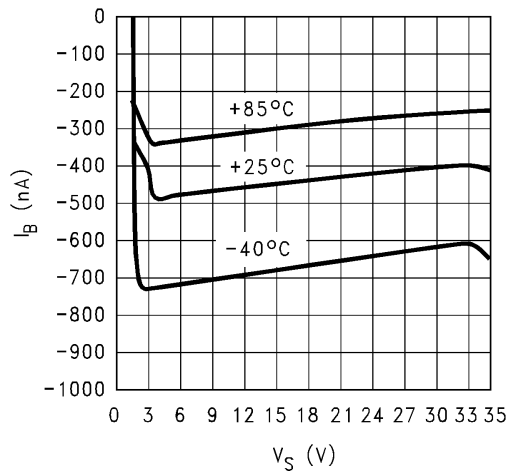

Bias Current vs. V<sub>CM</sub>

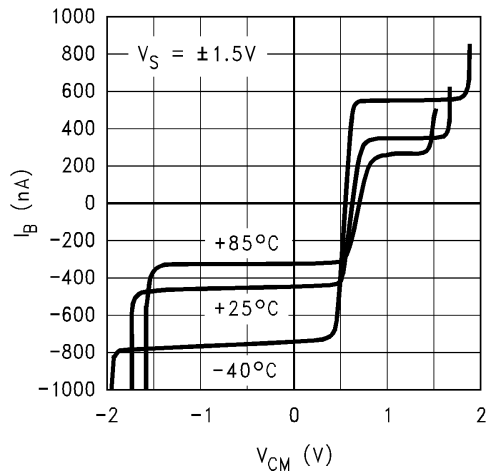

Bias Current vs. V<sub>CM</sub>

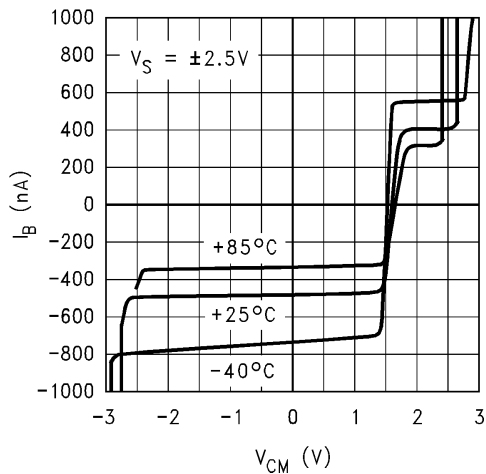

Bias Current vs. V<sub>CM</sub>

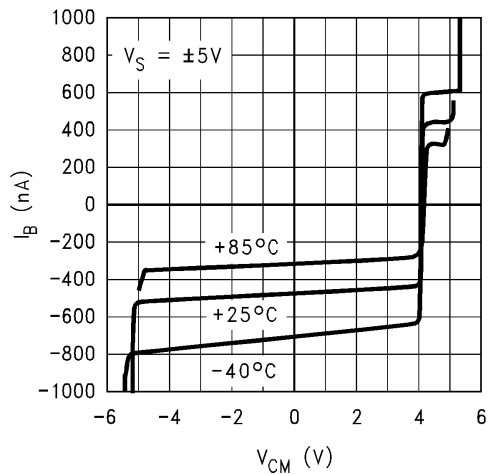

Typical Performance Characteristics (Continued)

Output Voltage vs. Source Current

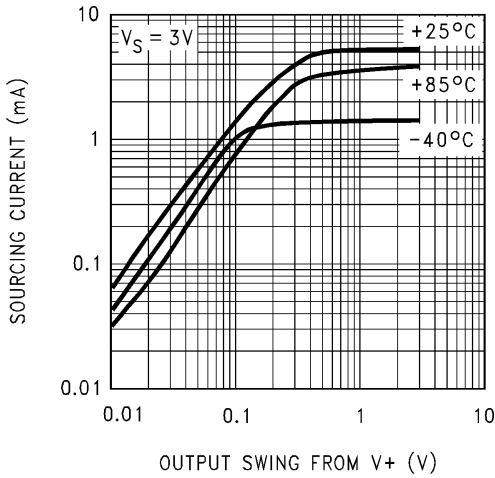

Output Voltage vs. Source Current

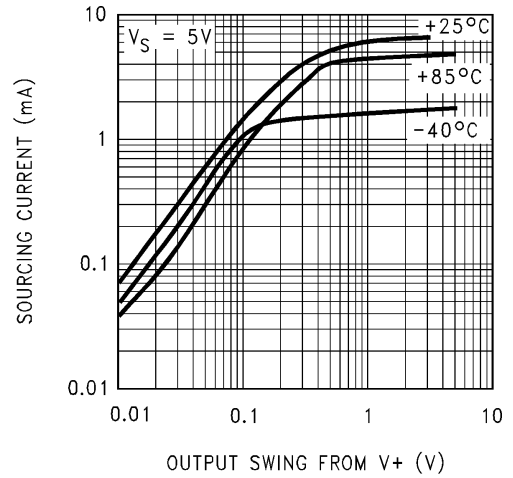

Output Voltage vs. Source Current

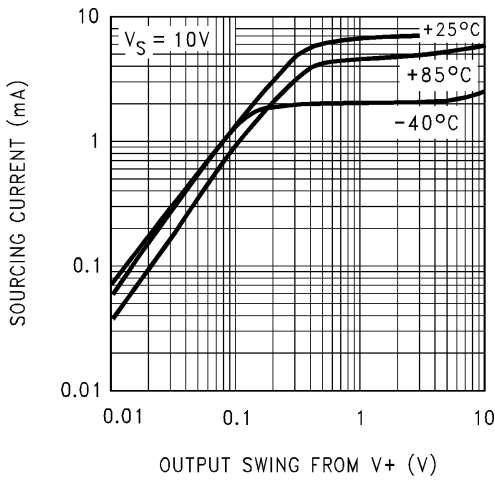

Output Voltage vs. Sink Current

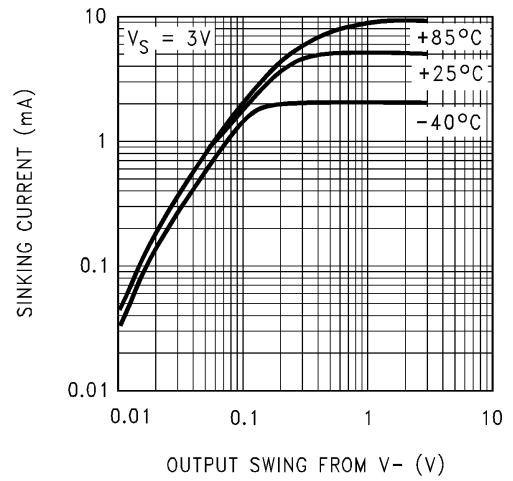

Output Voltage vs. Sink Current

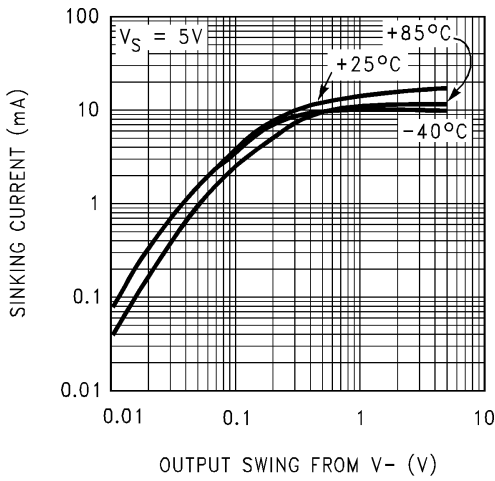

Output Voltage vs. Sink Current

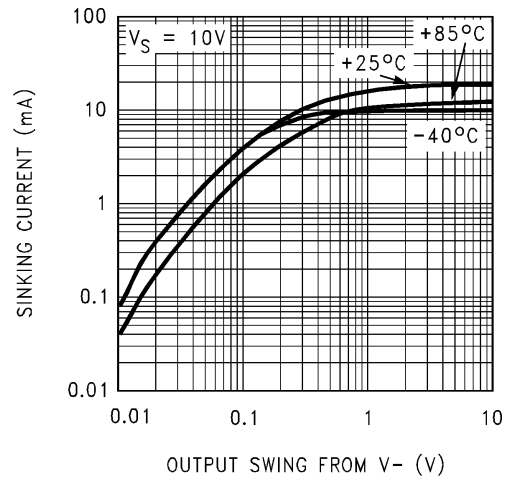

# Typical Performance Characteristics (Continued)

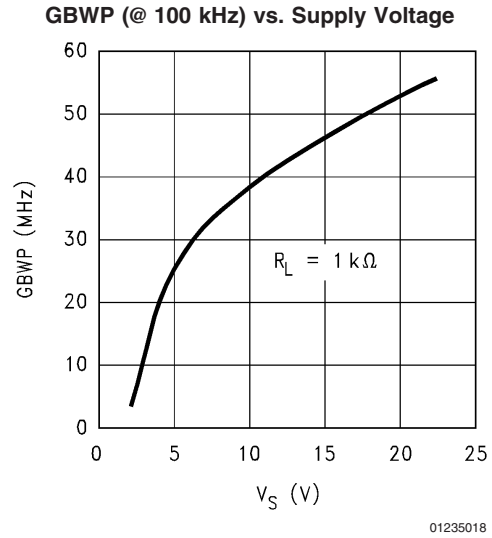
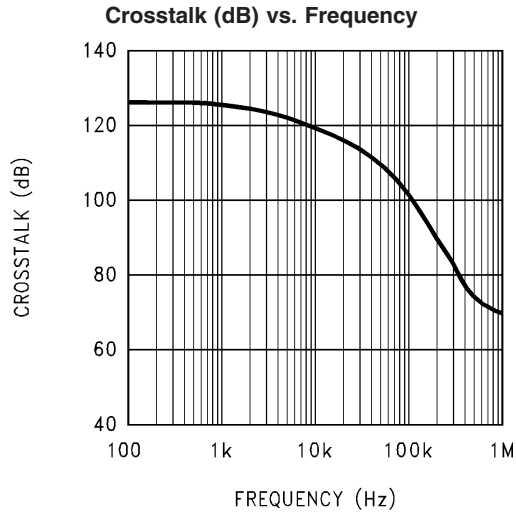

### Unity Gain Frequency vs. Supply Voltage for Various Loads

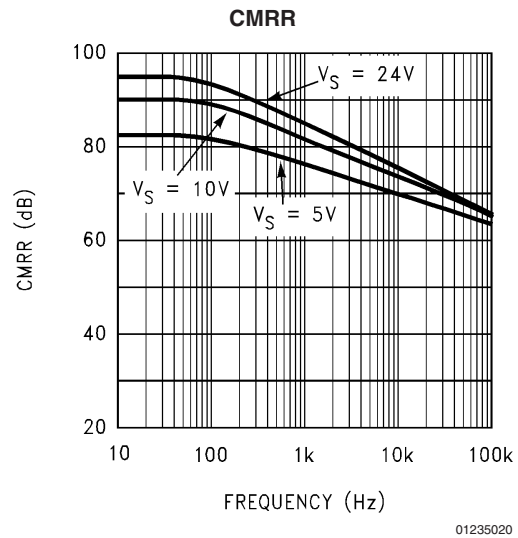
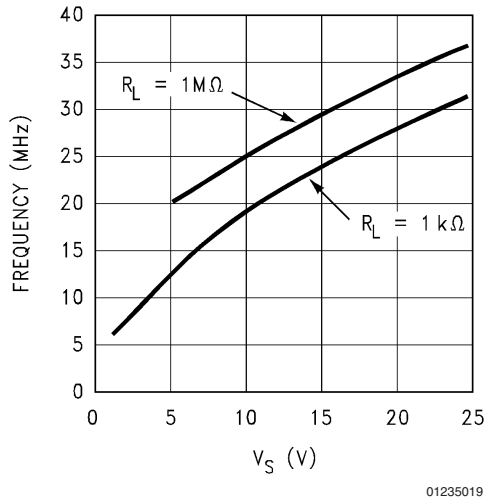

### Voltage Swing vs. Frequency (CL = 100 pF)

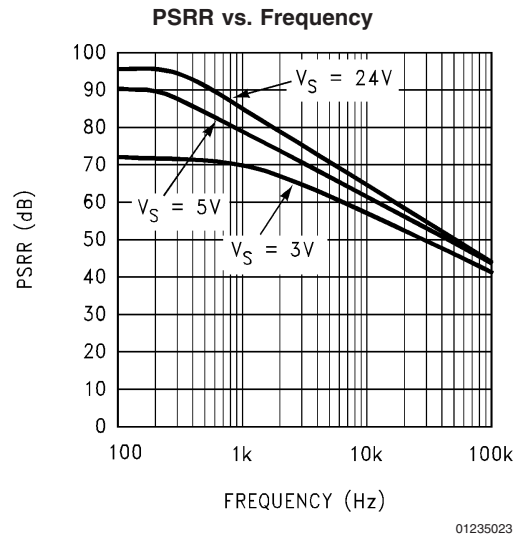
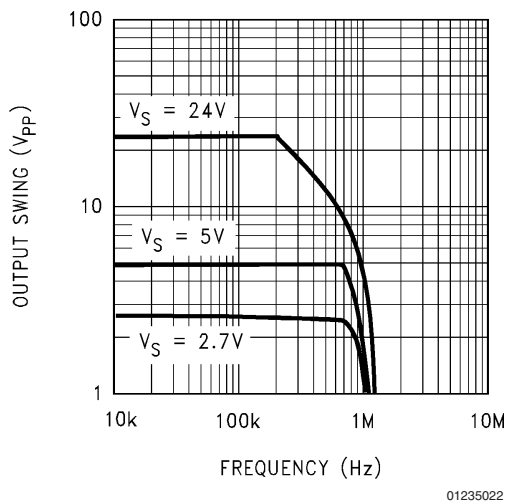

Typical Performance Characteristics (Continued)

Open Loop Gain/Phase  
( $V_S = 5V$ )

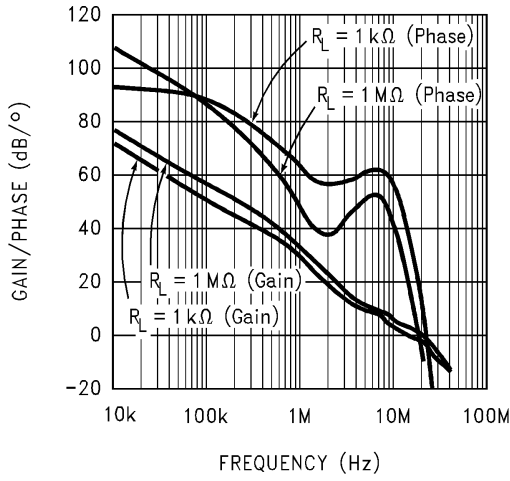

01235024

Open Loop Gain/Phase  
( $V_S = 10V$ )

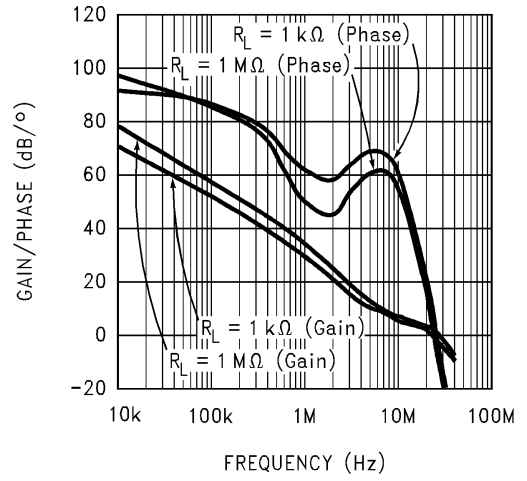

01235025

Open Loop Gain/Phase  
( $V_S = 24V$ )

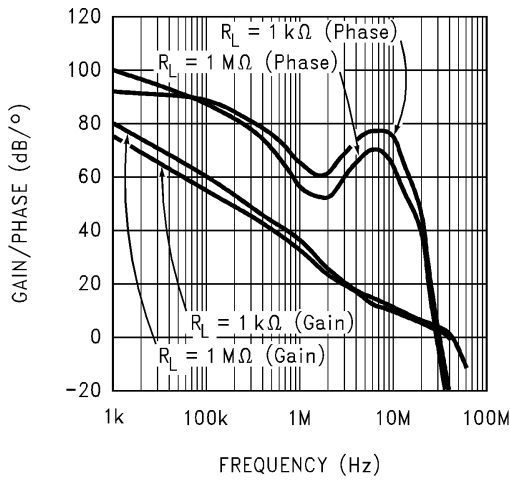

01235026

Noise Voltage vs. Frequency

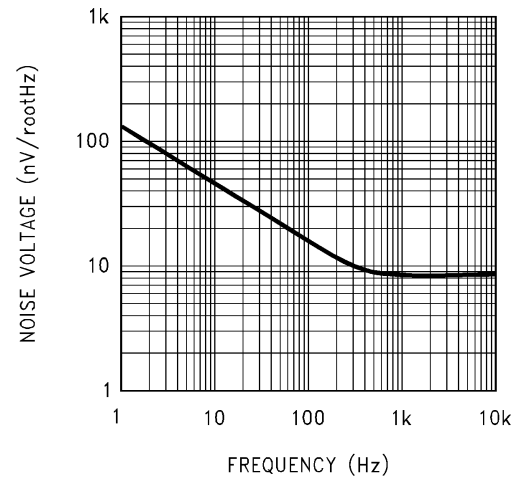

01235027

Noise Current vs. Frequency

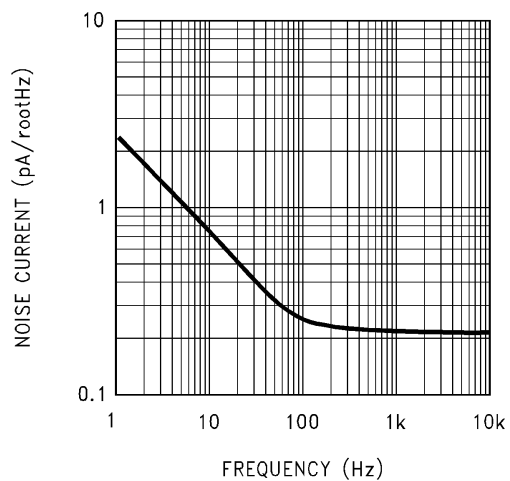

01235028

Voltage Error vs. Settle Time

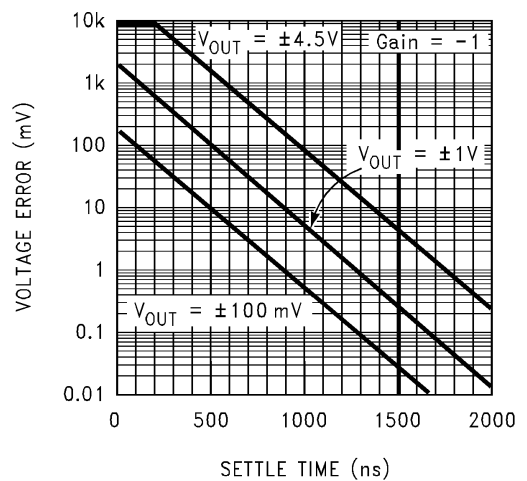

01235029



## Typical Performance Characteristics (Continued)

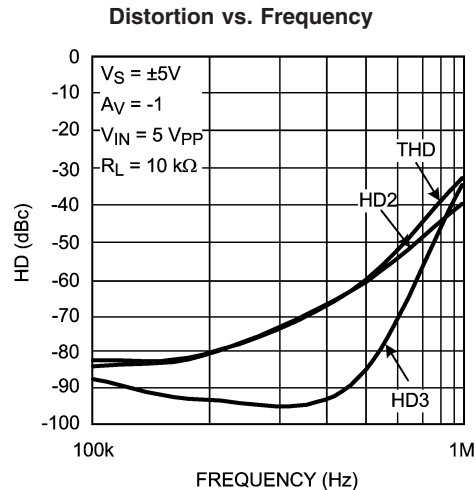

### Application Information

The LM6152/LM6154 is ideally suited for operation with about 10 k $\Omega$  (Feedback Resistor,  $R_F$ ) between the output and the negative input terminal.

With  $R_F$  set to this value, for most applications requiring a close loop gain of 10 or less, an additional small compensation capacitor ( $C_F$ ) (see Figure 1) is recommended across  $R_F$  in order to achieve a reasonable overshoot (10%) at the output by compensating for stray capacitance across the inputs.

The optimum value for  $C_F$  can best be established experimentally with a trimmer cap in place since its value is dependant on the supply voltage, output driving load, and the operating gain. Below, some typical values used in an inverting configuration and driving a 10 k $\Omega$  load have been tabulated for reference:

**TABLE 1. Typical BW (-3 dB) at Various Supply Voltage and Gains**

$V_S$ Volts	Gain	$C_F$ pF	BW (-3 dB) MHz
3	-1	5.6	4
	-10	6.8	1.97
	-100	None	0.797
24	-1	2.2	6.6
	-10	4.7	2.2
	-100	None	0.962

In the non-inverting configuration, the LM6152/LM6154 can be used for closed loop gains of +2 and above. In this case, also, the compensation capacitor ( $C_F$ ) is recommended across  $R_F$  (= 10 k $\Omega$ ) for gains of 10 or less.

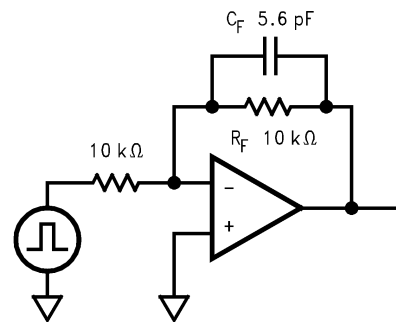

**FIGURE 1. Typical Inverting Gain Circuit  $A_V = -1$**

Because of the unique structure of this amplifier, when used at low closed loop gains, the realizable BW will be much less than the GBW product would suggest.

The LM6152/LM6154 brings a new level of ease of use to op amp system design.

The greater than rail-to-rail input voltage range eliminates concern over exceeding the common-mode voltage range. The rail-to-rail output swing provides the maximum possible dynamic range at the output. This is particularly important when operating on low supply voltages.

The high gain-bandwidth with low supply current opens new battery powered applications where higher power consumption previously reduced battery life to unacceptable levels.

The ability to drive large capacitive loads without oscillating functional removes this common problem.

To take advantage of these features, some ideas should be kept in mind.

The LM6152/LM6154, capacitive loads do not lead to oscillations, in all but the most extreme conditions, but they will result in reduced bandwidth. They also cause increased settling time.

## Application Information (Continued)

Unlike most bipolar op amps, the unique phase reversal prevention/speed-up circuit in the input stage, caused the slew rate to be very much a function of the input pulse amplitude. This results in a 10 to 1 increase in slew rate when the differential input signal increases. Large fast pulses will raise the slew-rate to more than 30 V/ $\mu$ s.

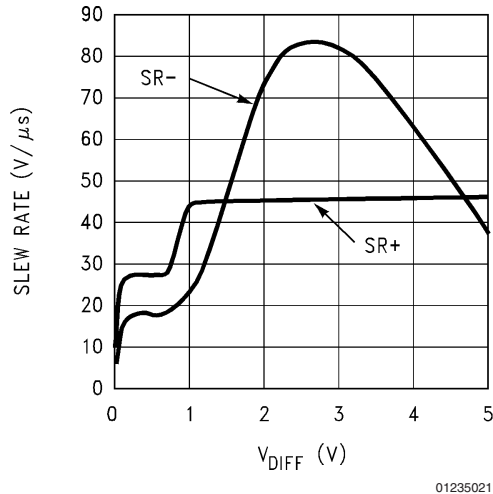

FIGURE 2. Slew Rate vs.  $V_{DIFF}$

The speed-up action adds stability to the system when driving large capacitive loads.

A conventional op amp exhibits a fixed maximum slew-rate even though the differential input voltage rises due to the lagging output voltage. In the LM6152/LM6154, increasing lag causes the differential input voltage to increase but as it does, the increased slew-rate keeps the output following the input much better. This effectively reduces phase lag. As a result, the LM6152/LM6154 can drive capacitive loads as large as 470 pF at gain of 2 and above, and not oscillate.

Capacitive loads decrease the phase margin of all op amps. This can lead to overshoot, ringing and oscillation. This is caused by the output resistance of the amplifier and the load capacitance forming an R-C phase shift network. The LM6152/6154 senses this phase shift and partly compensates for this effect.

**Physical Dimensions** inches (millimeters) unless otherwise noted

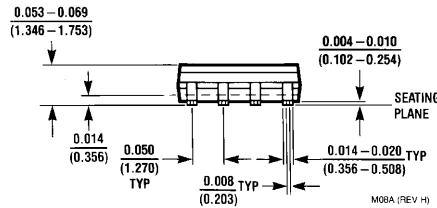
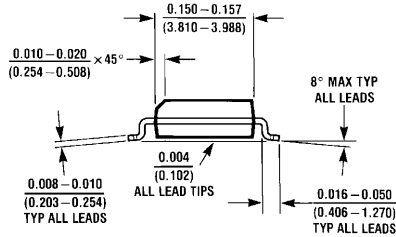
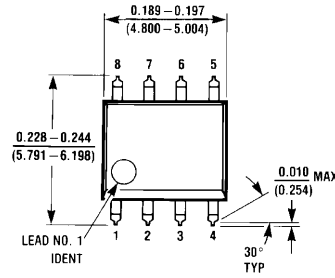

**8-Pin SOIC**  
NSC Package Number M08A

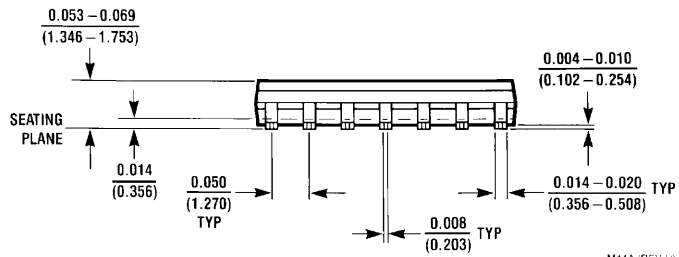
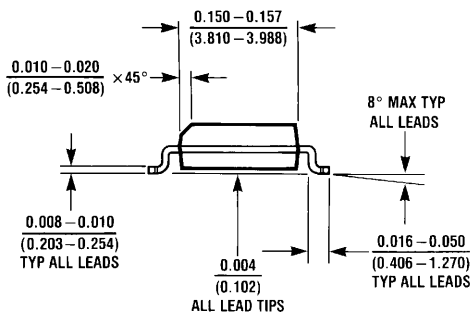
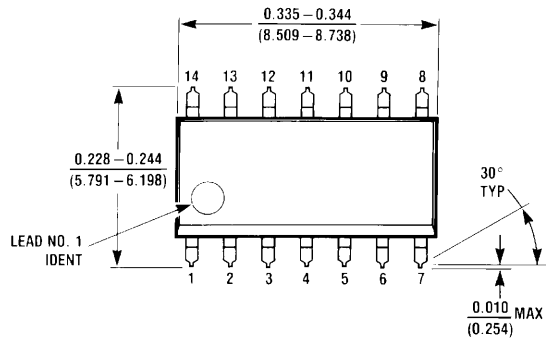

**14-Pin SOIC**  
NSC Package Number M14A

## Notes

National does not assume any responsibility for use of any circuitry described, no circuit patent licenses are implied and National reserves the right at any time without notice to change said circuitry and specifications.

For the most current product information visit us at [www.national.com](http://www.national.com).

### LIFE SUPPORT POLICY

NATIONAL'S PRODUCTS ARE NOT AUTHORIZED FOR USE AS CRITICAL COMPONENTS IN LIFE SUPPORT DEVICES OR SYSTEMS WITHOUT THE EXPRESS WRITTEN APPROVAL OF THE PRESIDENT AND GENERAL COUNSEL OF NATIONAL SEMICONDUCTOR CORPORATION. As used herein:

1. Life support devices or systems are devices or systems which, (a) are intended for surgical implant into the body, or (b) support or sustain life, and whose failure to perform when properly used in accordance with instructions for use provided in the labeling, can be reasonably expected to result in a significant injury to the user.
2. A critical component is any component of a life support device or system whose failure to perform can be reasonably expected to cause the failure of the life support device or system, or to affect its safety or effectiveness.

### BANNED SUBSTANCE COMPLIANCE

National Semiconductor manufactures products and uses packing materials that meet the provisions of the Customer Products Stewardship Specification (CSP-9-111C2) and the Banned Substances and Materials of Interest Specification (CSP-9-111S2) and contain no "Banned Substances" as defined in CSP-9-111S2.

Leadfree products are RoHS compliant.



**National Semiconductor**  
Americas Customer  
Support Center  
Email: [new.feedback@nsc.com](mailto:new.feedback@nsc.com)  
Tel: 1-800-272-9959

[www.national.com](http://www.national.com)

**National Semiconductor**  
Europe Customer Support Center  
Fax: +49 (0) 180-530 85 86  
Email: [europe.support@nsc.com](mailto:europe.support@nsc.com)  
Deutsch Tel: +49 (0) 69 9508 6208  
English Tel: +44 (0) 870 24 0 2171  
Français Tel: +33 (0) 1 41 91 8790

**National Semiconductor**  
Asia Pacific Customer  
Support Center  
Email: [ap.support@nsc.com](mailto:ap.support@nsc.com)

**National Semiconductor**  
Japan Customer Support Center  
Fax: 81-3-5639-7507  
Email: [jpn.feedback@nsc.com](mailto:jpn.feedback@nsc.com)  
Tel: 81-3-5639-7560