

TOSHIBA Bipolar Linear Integrated Circuit Silicon Monolithic

**TA7805SB, TA78057SB, TA7806SB, TA7807SB, TA7808SB, TA7809SB,
TA7810SB, TA7812SB, TA7815SB, TA7818SB, TA7820SB, TA7824SB**

Three-Terminal Positive Voltage Regulators

5 V, 5.7 V, 6 V, 7 V, 8 V, 9 V, 10 V, 12 V, 15 V, 18 V, 20 V, 24 V

Features

- Suitable for CMOS, TTL, the power supply of other digital ICs
- Internal thermal overload protection
- Internal short circuit current limiting
- Maximum output current of 1 A
- Package in the plastic case TPL (P_D: 1.8 W)

Pin Assignment

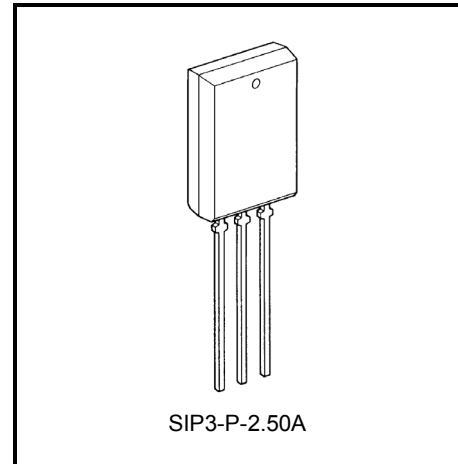
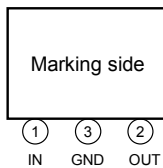

Weight: 1.5 g (Typ.)

Marking

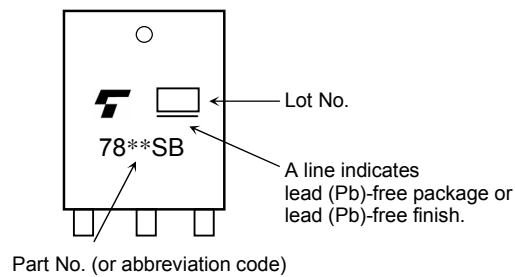

Note 1: The “**” in the each product number is replaces with the output voltage of each product.

Equivalent Circuit

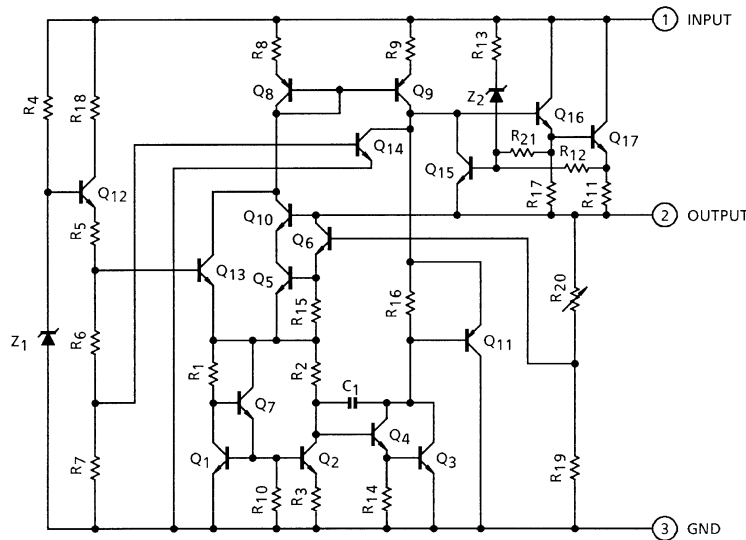

Absolute Maximum Ratings (Ta = 25°C)

Characteristics	Symbol	Rating	Unit			
Input voltage	V _{IN}	35	V			
				TA7805SB		
				TA78057SB		
				TA7806SB		
				TA7807SB		
				TA7808SB		
				TA7809SB		
				TA7810SB		
				TA7812SB		
				TA7815SB		
		Power dissipation (Ta = 25°C)		P _D	40	W
					1.8	
Operating temperature	T _{opr}	-30~85	°C			
Storage temperature	T _{stg}	-55~150	°C			
Junction temperature	T _j	150	°C			
Thermal resistance	R _{th(j-a)}	69.4	°C/W			

Note 2: Using continuously under heavy loads (e.g. the application of high temperature/current/voltage and the significant change in temperature, etc.) may cause this product to decrease in the reliability significantly even if the operating conditions (i.e. operating temperature/current/voltage, etc.) are within the absolute maximum ratings and the operating ranges.

Please design the appropriate reliability upon reviewing the Toshiba Semiconductor Reliability Handbook ("Handling Precautions"/Derating Concept and Methods) and individual reliability data (i.e. reliability test report and estimated failure rate, etc).

TA7805SB

Electrical Characteristics

(Unless otherwise specified, $V_{IN} = 10\text{ V}$, $I_{OUT} = 500\text{ mA}$, $0^\circ\text{C} \leq T_j \leq 125^\circ\text{C}$)

Characteristics	Symbol	Test Circuit	Test Condition	Min	Typ.	Max	Unit	
Output voltage	V_{OUT}	1	$T_j = 25^\circ\text{C}$, $I_{OUT} = 100\text{ mA}$	4.8	5.0	5.2	V	
Line regulation	Reg.line	1	$T_j = 25^\circ\text{C}$	$7.0\text{ V} \leq V_{IN} \leq 25\text{ V}$	—	3	100	mV
				$8.0\text{ V} \leq V_{IN} \leq 12\text{ V}$	—	1	50	
Load regulation	Reg.load	1	$T_j = 25^\circ\text{C}$	$5\text{ mA} \leq I_{OUT} \leq 1.4\text{ A}$	—	15	100	mV
				$250\text{ mA} \leq I_{OUT} \leq 750\text{ mA}$	—	5	50	
Output voltage	V_{OUT}	1	$T_j = 25^\circ\text{C}$ $7.0\text{ V} \leq V_{IN} \leq 20\text{ V}$ $5.0\text{ mA} \leq I_{OUT} \leq 1.0\text{ A}$	4.75	—	5.25	V	
Quiescent current	I_B	1	$T_j = 25^\circ\text{C}$, $I_{OUT} = 5\text{ mA}$	—	4.2	8.0	mA	
Quiescent current change	ΔI_B	1	$7.0\text{ V} \leq V_{IN} \leq 25\text{ V}$, $I_{OUT} = 5\text{ mA}$, $T_j = 25^\circ\text{C}$	—	—	1.3	mA	
Output noise voltage	V_{NO}	2	$T_a = 25^\circ\text{C}$, $10\text{ Hz} \leq f \leq 100\text{ kHz}$ $I_{OUT} = 50\text{ mA}$	—	50	—	μV_{rms}	
Ripple rejection	R.R.	3	$f = 120\text{ Hz}$, $8.0\text{ V} \leq V_{IN} \leq 18\text{ V}$ $I_{OUT} = 50\text{ mA}$, $T_j = 25^\circ\text{C}$	62	78	—	dB	
Dropout voltage	V_D	1	$I_{OUT} = 1.0\text{ A}$, $T_j = 25^\circ\text{C}$	—	2.0	—	V	
Short circuit current limit	I_{SC}	1	$T_j = 25^\circ\text{C}$	—	1.6	—	A	
Average temperature coefficient of output voltage	T_{CVO}	1	$I_{OUT} = 5\text{ mA}$	—	-0.6	—	$\text{mV}/^\circ\text{C}$	

TA78057SB

Electrical Characteristics

(Unless otherwise specified, $V_{IN} = 10.7\text{ V}$, $I_{OUT} = 500\text{ mA}$, $0^\circ\text{C} \leq T_j \leq 125^\circ\text{C}$)

Characteristics	Symbol	Test Circuit	Test Condition	Min	Typ.	Max	Unit	
Output voltage	V_{OUT}	1	$T_j = 25^\circ\text{C}$, $I_{OUT} = 100\text{ mA}$	5.47	5.7	5.93	V	
Line regulation	Reg.line	1	$T_j = 25^\circ\text{C}$	$7.7\text{ V} \leq V_{IN} \leq 25\text{ V}$	—	4	110	mV
				$8.7\text{ V} \leq V_{IN} \leq 12.7\text{ V}$	—	2	55	
Load regulation	Reg.load	1	$T_j = 25^\circ\text{C}$	$5\text{ mA} \leq I_{OUT} \leq 1.4\text{ A}$	—	15	110	mV
				$250\text{ mA} \leq I_{OUT} \leq 750\text{ mA}$	—	5	55	
Output voltage	V_{OUT}	1	$T_j = 25^\circ\text{C}$ $7.7\text{ V} \leq V_{IN} \leq 20.7\text{ V}$ $5.0\text{ mA} \leq I_{OUT} \leq 1.0\text{ A}$	5.42	—	5.98	V	
Quiescent current	I_B	1	$T_j = 25^\circ\text{C}$, $I_{OUT} = 5\text{ mA}$	—	4.3	8.0	mA	
Quiescent current change	ΔI_B	1	$7.7\text{ V} \leq V_{IN} \leq 25\text{ V}$, $I_{OUT} = 5\text{ mA}$, $T_j = 25^\circ\text{C}$	—	—	1.3	mA	
Output noise voltage	V_{NO}	2	$T_a = 25^\circ\text{C}$, $10\text{ Hz} \leq f \leq 100\text{ kHz}$ $I_{OUT} = 50\text{ mA}$	—	55	—	μV_{rms}	
Ripple rejection	R.R.	3	$f = 120\text{ Hz}$, $8.8\text{ V} \leq V_{IN} \leq 18.8\text{ V}$, $I_{OUT} = 50\text{ mA}$, $T_j = 25^\circ\text{C}$	62	77	—	dB	
Dropout voltage	V_D	1	$I_{OUT} = 1.0\text{ A}$, $T_j = 25^\circ\text{C}$	—	2.0	—	V	
Short circuit current limit	I_{SC}	1	$T_j = 25^\circ\text{C}$	—	1.5	—	A	
Average temperature coefficient of output voltage	T_{CVO}	1	$I_{OUT} = 5\text{ mA}$	—	-0.7	—	$\text{mV}/^\circ\text{C}$	

TA7806SB

Electrical Characteristics

(Unless otherwise specified, $V_{IN} = 11\text{ V}$, $I_{OUT} = 500\text{ mA}$, $0^\circ\text{C} \leq T_j \leq 125^\circ\text{C}$)

Characteristics	Symbol	Test Circuit	Test Condition	Min	Typ.	Max	Unit	
Output voltage	V_{OUT}	1	$T_j = 25^\circ\text{C}$, $I_{OUT} = 100\text{ mA}$	5.75	6.0	6.25	V	
Line regulation	Reg.line	1	$T_j = 25^\circ\text{C}$	$8.0\text{ V} \leq V_{IN} \leq 25\text{ V}$	—	4	120	mV
				$9\text{ V} \leq V_{IN} \leq 13\text{ V}$	—	2	60	
Load regulation	Reg.load	1	$T_j = 25^\circ\text{C}$	$5\text{ mA} \leq I_{OUT} \leq 1.4\text{ A}$	—	15	120	mV
				$250\text{ mA} \leq I_{OUT} \leq 750\text{ mA}$	—	5	60	
Output voltage	V_{OUT}	1	$T_j = 25^\circ\text{C}$ $8\text{ V} \leq V_{IN} \leq 21\text{ V}$ $5.0\text{ mA} \leq I_{OUT} \leq 1.0\text{ A}$	5.7	—	6.3	V	
Quiescent current	I_B	1	$T_j = 25^\circ\text{C}$, $I_{OUT} = 5\text{ mA}$	—	4.3	8.0	mA	
Quiescent current change	ΔI_B	1	$8.0\text{ V} \leq V_{IN} \leq 25\text{ V}$, $I_{OUT} = 5\text{ mA}$, $T_j = 25^\circ\text{C}$	—	—	1.3	mA	
Output noise voltage	V_{NO}	2	$T_a = 25^\circ\text{C}$, $10\text{ Hz} \leq f \leq 100\text{ kHz}$ $I_{OUT} = 50\text{ mA}$	—	55	—	μV_{rms}	
Ripple rejection	R.R.	3	$f = 120\text{ Hz}$, $9\text{ V} \leq V_{IN} \leq 19\text{ V}$ $I_{OUT} = 50\text{ mA}$, $T_j = 25^\circ\text{C}$	61	77	—	dB	
Dropout voltage	V_D	1	$I_{OUT} = 1.0\text{ A}$, $T_j = 25^\circ\text{C}$	—	2.0	—	V	
Short circuit current limit	I_{SC}	1	$T_j = 25^\circ\text{C}$	—	1.5	—	A	
Average temperature coefficient of output voltage	T_{CVO}	1	$I_{OUT} = 5\text{ mA}$	—	-0.7	—	$\text{mV}/^\circ\text{C}$	

TA7807SB

Electrical Characteristics

(Unless otherwise specified, $V_{IN} = 12\text{ V}$, $I_{OUT} = 500\text{ mA}$, $0^\circ\text{C} \leq T_j \leq 125^\circ\text{C}$)

Characteristics	Symbol	Test Circuit	Test Condition	Min	Typ.	Max	Unit	
Output voltage	V_{OUT}	1	$T_j = 25^\circ\text{C}$, $I_{OUT} = 100\text{ mA}$	6.72	7.0	7.28	V	
Line regulation	Reg.line	1	$T_j = 25^\circ\text{C}$	$9\text{ V} \leq V_{IN} \leq 25\text{ V}$	—	5	140	mV
				$10\text{ V} \leq V_{IN} \leq 14\text{ V}$	—	2	70	
Load regulation	Reg.load	1	$T_j = 25^\circ\text{C}$	$5\text{ mA} \leq I_{OUT} \leq 1.4\text{ A}$	—	15	140	mV
				$250\text{ mA} \leq I_{OUT} \leq 750\text{ mA}$	—	5	70	
Output voltage	V_{OUT}	1	$T_j = 25^\circ\text{C}$ $9\text{ V} \leq V_{IN} \leq 22\text{ V}$ $5.0\text{ mA} \leq I_{OUT} \leq 1.0\text{ A}$	6.65	—	7.35	V	
Quiescent current	I_B	1	$T_j = 25^\circ\text{C}$, $I_{OUT} = 5\text{ mA}$	—	4.3	8.0	mA	
Quiescent current change	ΔI_B	1	$9\text{ V} \leq V_{IN} \leq 25\text{ V}$, $I_{OUT} = 5\text{ mA}$, $T_j = 25^\circ\text{C}$	—	—	1.3	mA	
Output noise voltage	V_{NO}	2	$T_a = 25^\circ\text{C}$, $10\text{ Hz} \leq f \leq 100\text{ kHz}$ $I_{OUT} = 50\text{ mA}$	—	60	—	μV_{rms}	
Ripple rejection	R.R.	3	$f = 120\text{ Hz}$, $10\text{ V} \leq V_{IN} \leq 20\text{ V}$ $I_{OUT} = 50\text{ mA}$, $T_j = 25^\circ\text{C}$	59	75	—	dB	
Dropout voltage	V_D	1	$I_{OUT} = 1.0\text{ A}$, $T_j = 25^\circ\text{C}$	—	2.0	—	V	
Short circuit current limit	I_{SC}	1	$T_j = 25^\circ\text{C}$	—	1.3	—	A	
Average temperature coefficient of output voltage	T_{CVO}	1	$I_{OUT} = 5\text{ mA}$	—	-0.8	—	$\text{mV}/^\circ\text{C}$	

TA7808SB

Electrical Characteristics

(Unless otherwise specified, $V_{IN} = 14\text{ V}$, $I_{OUT} = 500\text{ mA}$, $0^\circ\text{C} \leq T_j \leq 125^\circ\text{C}$)

Characteristics	Symbol	Test Circuit	Test Condition	Min	Typ.	Max	Unit	
Output voltage	V_{OUT}	1	$T_j = 25^\circ\text{C}$, $I_{OUT} = 100\text{ mA}$	7.7	8.0	8.3	V	
Line regulation	Reg.line	1	$T_j = 25^\circ\text{C}$	$10.5\text{ V} \leq V_{IN} \leq 25\text{ V}$	—	6	160	mV
				$11\text{ V} \leq V_{IN} \leq 17\text{ V}$	—	2	80	
Load regulation	Reg.load	1	$T_j = 25^\circ\text{C}$	$5\text{ mA} \leq I_{OUT} \leq 1.4\text{ A}$	—	12	160	mV
				$250\text{ mA} \leq I_{OUT} \leq 750\text{ mA}$	—	4	80	
Output voltage	V_{OUT}	1	$T_j = 25^\circ\text{C}$ $10.5\text{ V} \leq V_{IN} \leq 23\text{ V}$ $5.0\text{ mA} \leq I_{OUT} \leq 1.0\text{ A}$	7.6	—	8.4	V	
Quiescent current	I_B	1	$T_j = 25^\circ\text{C}$, $I_{OUT} = 5\text{ mA}$	—	4.3	8.0	mA	
Quiescent current change	ΔI_B	1	$10.5\text{ V} \leq V_{IN} \leq 25\text{ V}$, $I_{OUT} = 5\text{ mA}$, $T_j = 25^\circ\text{C}$	—	—	1.0	mA	
Output noise voltage	V_{NO}	2	$T_a = 25^\circ\text{C}$, $10\text{ Hz} \leq f \leq 100\text{ kHz}$ $I_{OUT} = 50\text{ mA}$	—	70	—	μV_{rms}	
Ripple rejection	R.R.	3	$f = 120\text{ Hz}$, $11.5\text{ V} \leq V_{IN} \leq 21.5\text{ V}$ $I_{OUT} = 50\text{ mA}$, $T_j = 25^\circ\text{C}$	58	74	—	dB	
Dropout voltage	V_D	1	$I_{OUT} = 1.0\text{ A}$, $T_j = 25^\circ\text{C}$	—	2.0	—	V	
Short circuit current limit	I_{SC}	1	$T_j = 25^\circ\text{C}$	—	1.1	—	A	
Average temperature coefficient of output voltage	T_{CVO}	1	$I_{OUT} = 5\text{ mA}$	—	-1.0	—	$\text{mV}/^\circ\text{C}$	

TA7809SB

Electrical Characteristics

(Unless otherwise specified, $V_{IN} = 15\text{ V}$, $I_{OUT} = 500\text{ mA}$, $0^\circ\text{C} \leq T_j \leq 125^\circ\text{C}$)

Characteristics	Symbol	Test Circuit	Test Condition	Min	Typ.	Max	Unit	
Output voltage	V_{OUT}	1	$T_j = 25^\circ\text{C}$, $I_{OUT} = 100\text{ mA}$	8.64	9.0	9.36	V	
Line regulation	Reg.line	1	$T_j = 25^\circ\text{C}$	$11.5\text{ V} \leq V_{IN} \leq 26\text{ V}$	—	7	180	mV
				$13\text{ V} \leq V_{IN} \leq 19\text{ V}$	—	2.5	90	
Load regulation	Reg.load	1	$T_j = 25^\circ\text{C}$	$5\text{ mA} \leq I_{OUT} \leq 1.4\text{ A}$	—	12	180	mV
				$250\text{ mA} \leq I_{OUT} \leq 750\text{ mA}$	—	4	90	
Output voltage	V_{OUT}	1	$T_j = 25^\circ\text{C}$ $11.5\text{ V} \leq V_{IN} \leq 24\text{ V}$ $5.0\text{ mA} \leq I_{OUT} \leq 1.0\text{ A}$	8.55	—	9.45	V	
Quiescent current	I_B	1	$T_j = 25^\circ\text{C}$, $I_{OUT} = 5\text{ mA}$	—	4.3	8.0	mA	
Quiescent current change	ΔI_B	1	$11.5\text{ V} \leq V_{IN} \leq 26\text{ V}$, $I_{OUT} = 5\text{ mA}$, $T_j = 25^\circ\text{C}$	—	—	1.0	mA	
Output noise voltage	V_{NO}	2	$T_a = 25^\circ\text{C}$, $10\text{ Hz} \leq f \leq 100\text{ kHz}$ $I_{OUT} = 50\text{ mA}$	—	75	—	μV_{rms}	
Ripple rejection	R.R.	3	$f = 120\text{ Hz}$, $12.5\text{ V} \leq V_{IN} \leq 22.5\text{ V}$ $I_{OUT} = 50\text{ mA}$, $T_j = 25^\circ\text{C}$	56	72	—	dB	
Dropout voltage	V_D	1	$I_{OUT} = 1.0\text{ A}$, $T_j = 25^\circ\text{C}$	—	2.0	—	V	
Short circuit current limit	I_{SC}	1	$T_j = 25^\circ\text{C}$	—	1.0	—	A	
Average temperature coefficient of output voltage	T_{CVO}	1	$I_{OUT} = 5\text{ mA}$	—	-1.1	—	$\text{mV}/^\circ\text{C}$	

TA7810SB

Electrical Characteristics

(Unless otherwise specified, $V_{IN} = 16\text{ V}$, $I_{OUT} = 500\text{ mA}$, $0^\circ\text{C} \leq T_j \leq 125^\circ\text{C}$)

Characteristics	Symbol	Test Circuit	Test Condition	Min	Typ.	Max	Unit	
Output voltage	V_{OUT}	1	$T_j = 25^\circ\text{C}$, $I_{OUT} = 100\text{ mA}$	9.6	10.0	10.4	V	
Line regulation	Reg.line	1	$T_j = 25^\circ\text{C}$	$12.5\text{ V} \leq V_{IN} \leq 27\text{ V}$	—	8	200	mV
				$14\text{ V} \leq V_{IN} \leq 20\text{ V}$	—	2.5	100	
Load regulation	Reg.load	1	$T_j = 25^\circ\text{C}$	$5\text{ mA} \leq I_{OUT} \leq 1.4\text{ A}$	—	12	200	mV
				$250\text{ mA} \leq I_{OUT} \leq 750\text{ mA}$	—	4	100	
Output voltage	V_{OUT}	1	$T_j = 25^\circ\text{C}$ $12.5\text{ V} \leq V_{IN} \leq 25\text{ V}$ $5.0\text{ mA} \leq I_{OUT} \leq 1.0\text{ A}$	9.5	—	10.5	V	
Quiescent current	I_B	1	$T_j = 25^\circ\text{C}$, $I_{OUT} = 5\text{ mA}$	—	4.3	8.0	mA	
Quiescent current change	ΔI_B	1	$12.5\text{ V} \leq V_{IN} \leq 27\text{ V}$, $I_{OUT} = 5\text{ mA}$, $T_j = 25^\circ\text{C}$	—	—	1.0	mA	
Output noise voltage	V_{NO}	2	$T_a = 25^\circ\text{C}$, $10\text{ Hz} \leq f \leq 100\text{ kHz}$ $I_{OUT} = 50\text{ mA}$	—	80	—	μV_{rms}	
Ripple rejection	R.R.	3	$f = 120\text{ Hz}$, $13.5\text{ V} \leq V_{IN} \leq 23.5\text{ V}$ $I_{OUT} = 50\text{ mA}$, $T_j = 25^\circ\text{C}$	55	72	—	dB	
Dropout voltage	V_D	1	$I_{OUT} = 1.0\text{ A}$, $T_j = 25^\circ\text{C}$	—	2.0	—	V	
Short circuit current limit	I_{SC}	1	$T_j = 25^\circ\text{C}$	—	0.9	—	A	
Average temperature coefficient of output voltage	T_{CVO}	1	$I_{OUT} = 5\text{ mA}$	—	-1.3	—	$\text{mV}/^\circ\text{C}$	

TA7812SB

Electrical Characteristics

(Unless otherwise specified, $V_{IN} = 19\text{ V}$, $I_{OUT} = 500\text{ mA}$, $0^\circ\text{C} \leq T_j \leq 125^\circ\text{C}$)

Characteristics	Symbol	Test Circuit	Test Condition	Min	Typ.	Max	Unit	
Output voltage	V_{OUT}	1	$T_j = 25^\circ\text{C}$, $I_{OUT} = 100\text{ mA}$	11.5	12.0	12.5	V	
Line regulation	Reg.line	1	$T_j = 25^\circ\text{C}$	$14.5\text{ V} \leq V_{IN} \leq 30\text{ V}$	—	10	240	mV
				$16\text{ V} \leq V_{IN} \leq 22\text{ V}$	—	3	120	
Load regulation	Reg.load	1	$T_j = 25^\circ\text{C}$	$5\text{ mA} \leq I_{OUT} \leq 1.4\text{ A}$	—	12	240	mV
				$250\text{ mA} \leq I_{OUT} \leq 750\text{ mA}$	—	4	120	
Output voltage	V_{OUT}	1	$T_j = 25^\circ\text{C}$ $14.5\text{ V} \leq V_{IN} \leq 27\text{ V}$ $5.0\text{ mA} \leq I_{OUT} \leq 1.0\text{ A}$	11.4	—	12.6	V	
Quiescent current	I_B	1	$T_j = 25^\circ\text{C}$, $I_{OUT} = 5\text{ mA}$	—	4.3	8.0	mA	
Quiescent current change	ΔI_B	1	$14.5\text{ V} \leq V_{IN} \leq 30\text{ V}$, $I_{OUT} = 5\text{ mA}$, $T_j = 25^\circ\text{C}$	—	—	1.0	mA	
Output noise voltage	V_{NO}	2	$T_a = 25^\circ\text{C}$, $10\text{ Hz} \leq f \leq 100\text{ kHz}$ $I_{OUT} = 50\text{ mA}$	—	90	—	μV_{rms}	
Ripple rejection	R.R.	3	$f = 120\text{ Hz}$, $15\text{ V} \leq V_{IN} \leq 25\text{ V}$ $I_{OUT} = 50\text{ mA}$, $T_j = 25^\circ\text{C}$	55	71	—	dB	
Dropout voltage	V_D	1	$I_{OUT} = 1.0\text{ A}$, $T_j = 25^\circ\text{C}$	—	2.0	—	V	
Short circuit current limit	I_{SC}	1	$T_j = 25^\circ\text{C}$	—	0.7	—	A	
Average temperature coefficient of output voltage	T_{CVO}	1	$I_{OUT} = 5\text{ mA}$	—	-1.6	—	$\text{mV}/^\circ\text{C}$	

TA7815SB

Electrical Characteristics

(Unless otherwise specified, $V_{IN} = 23\text{ V}$, $I_{OUT} = 500\text{ mA}$, $0^\circ\text{C} \leq T_j \leq 125^\circ\text{C}$)

Characteristics	Symbol	Test Circuit	Test Condition	Min	Typ.	Max	Unit	
Output voltage	V_{OUT}	1	$T_j = 25^\circ\text{C}$, $I_{OUT} = 100\text{ mA}$	14.4	15.0	15.6	V	
Line regulation	Reg.line	1	$T_j = 25^\circ\text{C}$	$17.5\text{ V} \leq V_{IN} \leq 30\text{ V}$	—	11	300	mV
				$20\text{ V} \leq V_{IN} \leq 26\text{ V}$	—	3	150	
Load regulation	Reg.load	1	$T_j = 25^\circ\text{C}$	$5\text{ mA} \leq I_{OUT} \leq 1.4\text{ A}$	—	12	300	mV
				$250\text{ mA} \leq I_{OUT} \leq 750\text{ mA}$	—	4	150	
Output voltage	V_{OUT}	1	$T_j = 25^\circ\text{C}$ $17.5\text{ V} \leq V_{IN} \leq 30\text{ V}$ $5.0\text{ mA} \leq I_{OUT} \leq 1.0\text{ A}$	14.25	—	15.75	V	
Quiescent current	I_B	1	$T_j = 25^\circ\text{C}$, $I_{OUT} = 5\text{ mA}$	—	4.4	8.0	mA	
Quiescent current change	ΔI_B	1	$17.5\text{ V} \leq V_{IN} \leq 30\text{ V}$, $I_{OUT} = 5\text{ mA}$, $T_j = 25^\circ\text{C}$	—	—	1.0	mA	
Output noise voltage	V_{NO}	2	$T_a = 25^\circ\text{C}$, $10\text{ Hz} \leq f \leq 100\text{ kHz}$ $I_{OUT} = 50\text{ mA}$	—	110	—	μV_{rms}	
Ripple rejection	R.R.	3	$f = 120\text{ Hz}$, $18.5\text{ V} \leq V_{IN} \leq 28.5\text{ V}$ $I_{OUT} = 50\text{ mA}$, $T_j = 25^\circ\text{C}$	54	70	—	dB	
Dropout voltage	V_D	1	$I_{OUT} = 1.0\text{ A}$, $T_j = 25^\circ\text{C}$	—	2.0	—	V	
Short circuit current limit	I_{SC}	1	$T_j = 25^\circ\text{C}$	—	0.5	—	A	
Average temperature coefficient of output voltage	T_{CVO}	1	$I_{OUT} = 5\text{ mA}$	—	-2.0	—	$\text{mV}/^\circ\text{C}$	

TA7818SB

Electrical Characteristics

(Unless otherwise specified, $V_{IN} = 27\text{ V}$, $I_{OUT} = 500\text{ mA}$, $0^\circ\text{C} \leq T_j \leq 125^\circ\text{C}$)

Characteristics	Symbol	Test Circuit	Test Condition	Min	Typ.	Max	Unit	
Output voltage	V_{OUT}	1	$T_j = 25^\circ\text{C}$, $I_{OUT} = 100\text{ mA}$	17.3	18.0	18.7	V	
Line regulation	Reg.line	1	$T_j = 25^\circ\text{C}$	$21\text{ V} \leq V_{IN} \leq 33\text{ V}$	—	13	360	mV
				$24\text{ V} \leq V_{IN} \leq 30\text{ V}$	—	4	180	
Load regulation	Reg.load	1	$T_j = 25^\circ\text{C}$	$5\text{ mA} \leq I_{OUT} \leq 1.4\text{ A}$	—	12	360	mV
				$250\text{ mA} \leq I_{OUT} \leq 750\text{ mA}$	—	4	180	
Output voltage	V_{OUT}	1	$T_j = 25^\circ\text{C}$ $21\text{ V} \leq V_{IN} \leq 33\text{ V}$ $5.0\text{ mA} \leq I_{OUT} \leq 1.0\text{ A}$	17.1	—	18.9	V	
Quiescent current	I_B	1	$T_j = 25^\circ\text{C}$, $I_{OUT} = 5\text{ mA}$	—	4.5	8.0	mA	
Quiescent current change	ΔI_B	1	$21\text{ V} \leq V_{IN} \leq 33\text{ V}$, $I_{OUT} = 5\text{ mA}$, $T_j = 25^\circ\text{C}$	—	—	1.0	mA	
Output noise voltage	V_{NO}	2	$T_a = 25^\circ\text{C}$, $10\text{ Hz} \leq f \leq 100\text{ kHz}$ $I_{OUT} = 50\text{ mA}$	—	125	—	μV_{rms}	
Ripple rejection	R.R.	3	$f = 120\text{ Hz}$, $22\text{ V} \leq V_{IN} \leq 32\text{ V}$ $I_{OUT} = 50\text{ mA}$, $T_j = 25^\circ\text{C}$	52	68	—	dB	
Dropout voltage	V_D	1	$I_{OUT} = 1.0\text{ A}$, $T_j = 25^\circ\text{C}$	—	2.0	—	V	
Short circuit current limit	I_{SC}	1	$T_j = 25^\circ\text{C}$	—	0.4	—	A	
Average temperature coefficient of output voltage	T_{CVO}	1	$I_{OUT} = 5\text{ mA}$	—	-2.5	—	$\text{mV}/^\circ\text{C}$	

TA7820SB

Electrical Characteristics

(Unless otherwise specified, $V_{IN} = 29\text{ V}$, $I_{OUT} = 500\text{ mA}$, $0^\circ\text{C} \leq T_j \leq 125^\circ\text{C}$)

Characteristics	Symbol	Test Circuit	Test Condition	Min	Typ.	Max	Unit	
Output voltage	V_{OUT}	1	$T_j = 25^\circ\text{C}$, $I_{OUT} = 100\text{ mA}$	19.2	20.0	20.8	V	
Line regulation	Reg.line	1	$T_j = 25^\circ\text{C}$	$23\text{ V} \leq V_{IN} \leq 35\text{ V}$	—	15	400	mV
				$26\text{ V} \leq V_{IN} \leq 32\text{ V}$	—	5	200	
Load regulation	Reg.load	1	$T_j = 25^\circ\text{C}$	$5\text{ mA} \leq I_{OUT} \leq 1.4\text{ A}$	—	12	400	mV
				$250\text{ mA} \leq I_{OUT} \leq 750\text{ mA}$	—	4	200	
Output voltage	V_{OUT}	1	$T_j = 25^\circ\text{C}$ $23\text{ V} \leq V_{IN} \leq 35\text{ V}$ $5.0\text{ mA} \leq I_{OUT} \leq 1.0\text{ A}$	19.0	—	21.0	V	
Quiescent current	I_B	1	$T_j = 25^\circ\text{C}$, $I_{OUT} = 5\text{ mA}$	—	4.6	8.0	mA	
Quiescent current change	ΔI_B	1	$23\text{ V} \leq V_{IN} \leq 35\text{ V}$, $I_{OUT} = 5\text{ mA}$, $T_j = 25^\circ\text{C}$	—	—	1.0	mA	
Output noise voltage	V_{NO}	2	$T_a = 25^\circ\text{C}$, $10\text{ Hz} \leq f \leq 100\text{ kHz}$ $I_{OUT} = 50\text{ mA}$	—	135	—	μV_{rms}	
Ripple rejection	R.R.	3	$f = 120\text{ Hz}$, $24\text{ V} \leq V_{IN} \leq 34\text{ V}$ $I_{OUT} = 50\text{ mA}$, $T_j = 25^\circ\text{C}$	50	66	—	dB	
Dropout voltage	V_D	1	$I_{OUT} = 1.0\text{ A}$, $T_j = 25^\circ\text{C}$	—	2.0	—	V	
Short circuit current limit	I_{SC}	1	$T_j = 25^\circ\text{C}$	—	0.4	—	A	
Average temperature coefficient of output voltage	T_{CVO}	1	$I_{OUT} = 5\text{ mA}$	—	-3.0	—	$\text{mV}/^\circ\text{C}$	

TA7824SB

Electrical Characteristics

(Unless otherwise specified, $V_{IN} = 33\text{ V}$, $I_{OUT} = 500\text{ mA}$, $0^\circ\text{C} \leq T_j \leq 125^\circ\text{C}$)

Characteristics	Symbol	Test Circuit	Test Condition	Min	Typ.	Max	Unit	
Output voltage	V_{OUT}	1	$T_j = 25^\circ\text{C}$, $I_{OUT} = 100\text{ mA}$	23.0	24.0	25.0	V	
Line regulation	Reg.line	1	$T_j = 25^\circ\text{C}$	$27\text{ V} \leq V_{IN} \leq 38\text{ V}$	—	18	480	mV
				$30\text{ V} \leq V_{IN} \leq 36\text{ V}$	—	6	240	
Load regulation	Reg.load	1	$T_j = 25^\circ\text{C}$	$5\text{ mA} \leq I_{OUT} \leq 1.4\text{ A}$	—	12	480	mV
				$250\text{ mA} \leq I_{OUT} \leq 750\text{ mA}$	—	4	240	
Output voltage	V_{OUT}	1	$T_j = 25^\circ\text{C}$ $27\text{ V} \leq V_{IN} \leq 38\text{ V}$ $5.0\text{ mA} \leq I_{OUT} \leq 1.0\text{ A}$	22.8	—	25.2	V	
Quiescent current	I_B	1	$T_j = 25^\circ\text{C}$, $I_{OUT} = 5\text{ mA}$	—	4.6	8.0	mA	
Quiescent current change	ΔI_B	1	$27\text{ V} \leq V_{IN} \leq 38\text{ V}$, $I_{OUT} = 5\text{ mA}$, $T_j = 25^\circ\text{C}$	—	—	1.0	mA	
Output noise voltage	V_{NO}	2	$T_a = 25^\circ\text{C}$, $10\text{ Hz} \leq f \leq 100\text{ kHz}$ $I_{OUT} = 50\text{ mA}$	—	150	—	μV_{rms}	
Ripple rejection	R.R.	3	$f = 120\text{ Hz}$, $28\text{ V} \leq V_{IN} \leq 38\text{ V}$ $I_{OUT} = 50\text{ mA}$, $T_j = 25^\circ\text{C}$	50	66	—	dB	
Dropout voltage	V_D	1	$I_{OUT} = 1.0\text{ A}$, $T_j = 25^\circ\text{C}$	—	2.0	—	V	
Short circuit current limit	I_{SC}	1	$T_j = 25^\circ\text{C}$	—	0.3	—	A	
Average temperature coefficient of output voltage	T_{CVO}	1	$I_{OUT} = 5\text{ mA}$	—	-3.5	—	$\text{mV}/^\circ\text{C}$	

Test Circuit 1/Standard Application Circuit

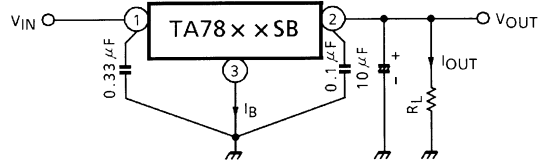

Test Circuit 2

V_{NO}

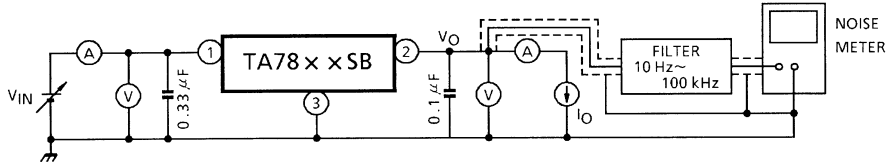

Test Circuit 3

R.R.

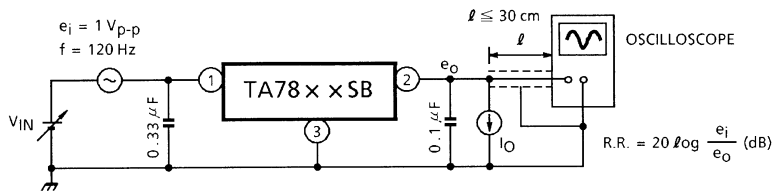

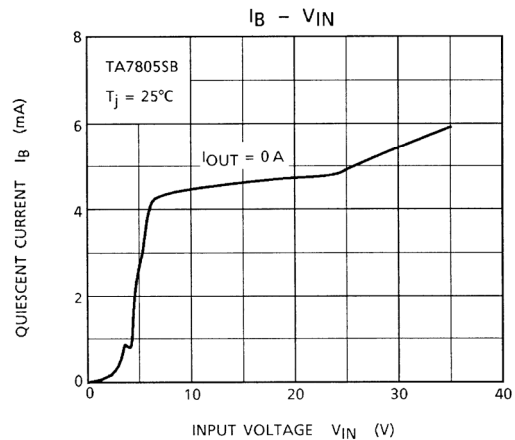
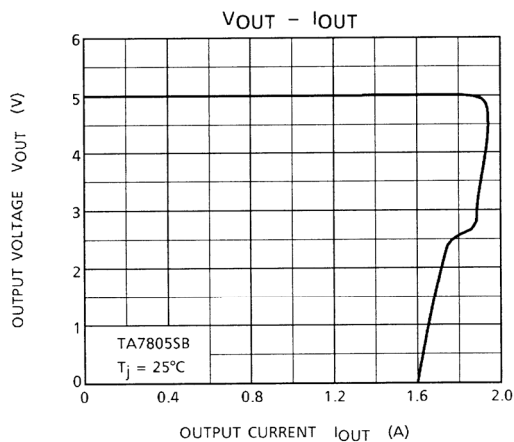
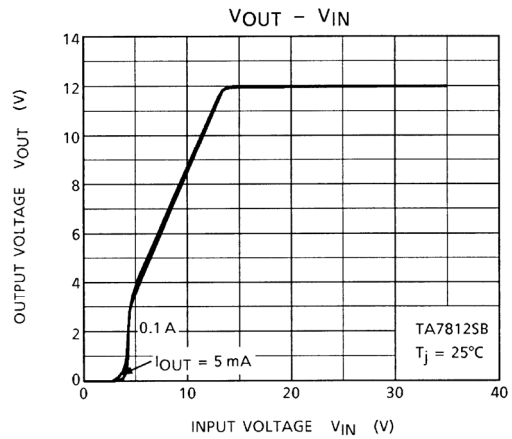
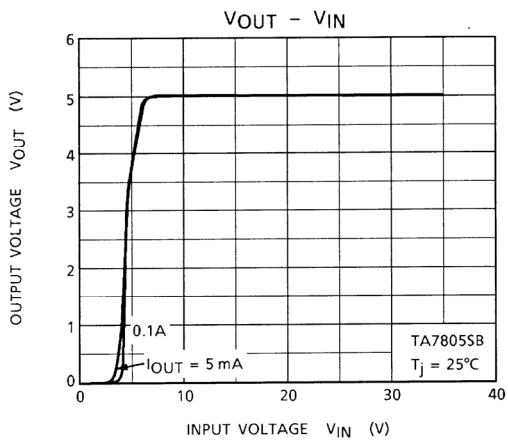
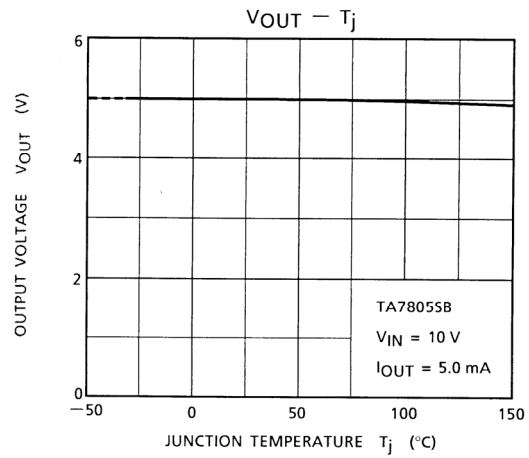
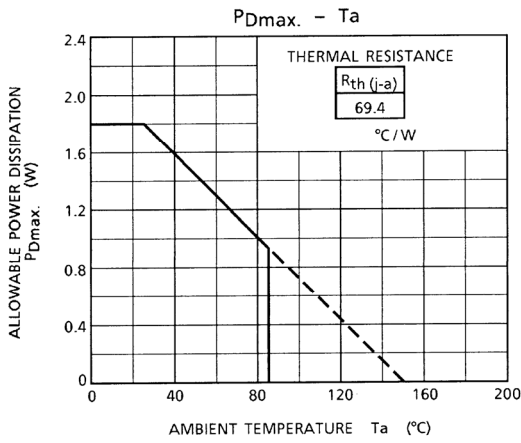

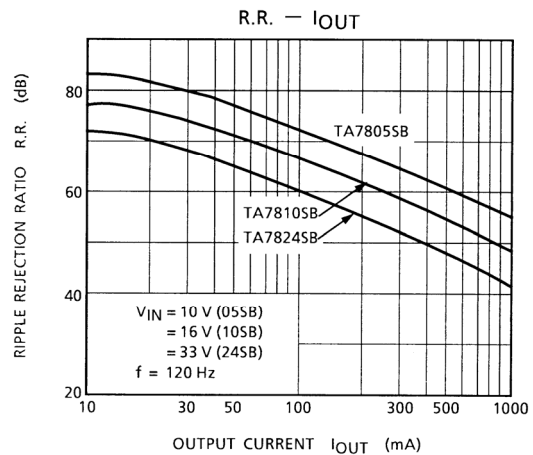
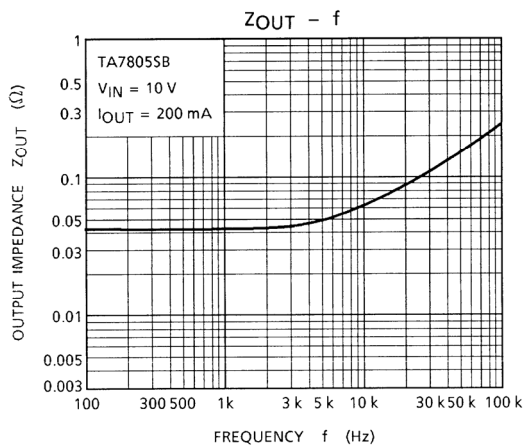
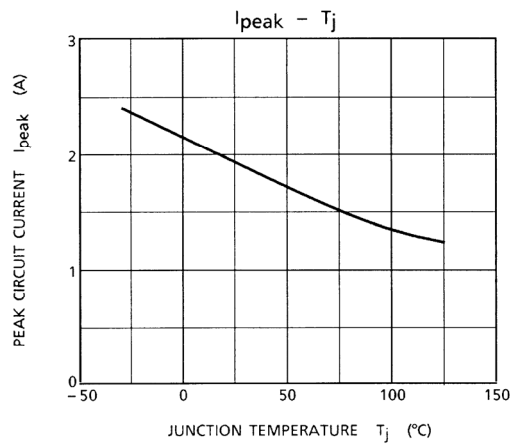
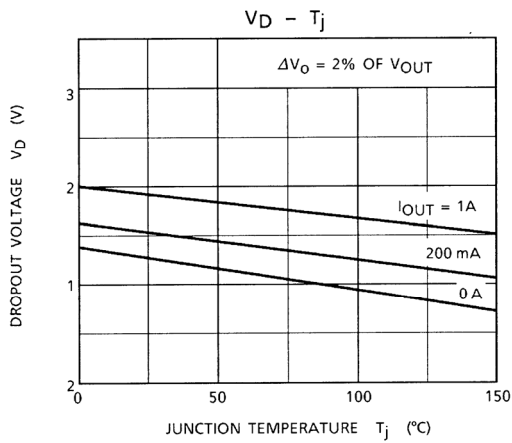
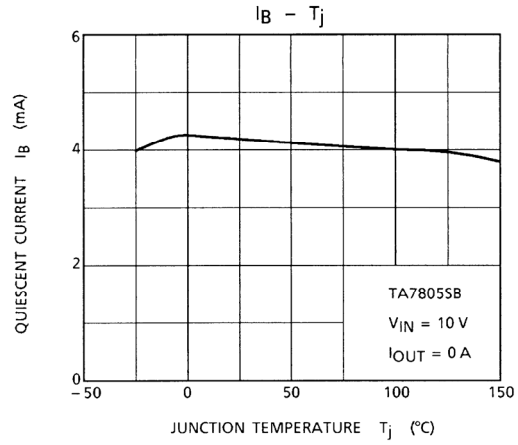
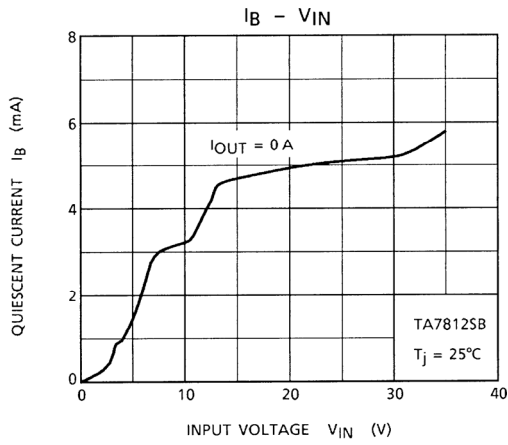

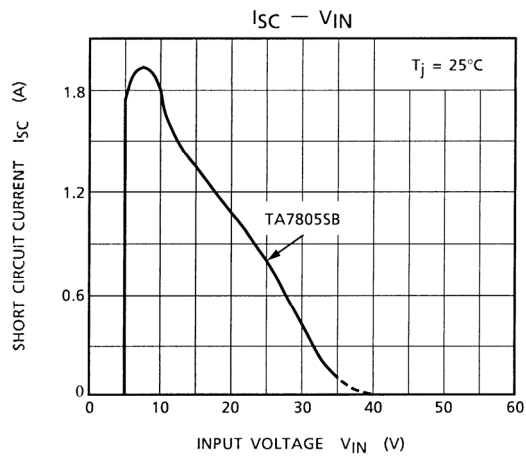

Precautions on Application

- (1) In regard to GND, be careful not to apply a negative voltage to the input/output terminal. Further, special care is necessary in the case of a voltage boost application.
- (2) If a surge voltage exceeding the absolute maximum rating is applied to the input terminal or if a voltage in excess of the input terminal voltage is applied to the output terminal, the circuit may be destroyed.

Particular care is necessary in the case of the latter.

Circuit destruction may also occur if the input terminal shorts to GND in a state of normal operation, causing the output terminal voltage to exceed the input voltage (GND potential) and the electrical charge of the chemical capacitor connected to the output terminal to flow into the input side.

Where these risks exist, take steps such as connecting zener and general silicon diodes to the circuit, as shown in the figure below.

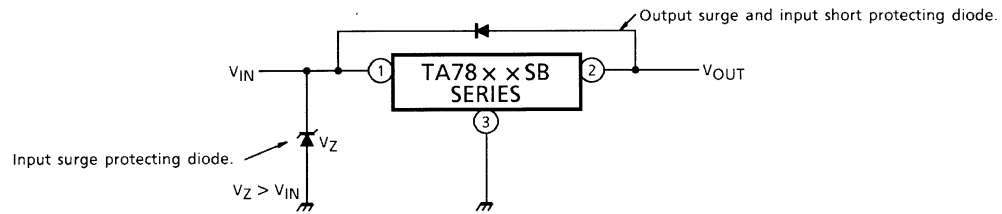

- (3) When the input voltage is too high, the power dissipation of the three-terminal regulator, which is a series regulator, increases, causing the junction temperature to rise. In such a case, it is recommended to reduce the power dissipation, and hence the junction temperature, by inserting a power-limiting resistor R_{SD} in the input terminal.

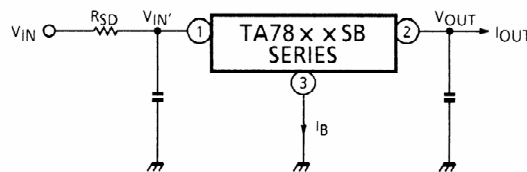

The power dissipation P_D of the IC is expressed in the following equation.

$$P_D = (V_{IN'} - V_{OUT}) \cdot I_{OUT} + V_{IN'} \cdot I_B$$

Reducing $V_{IN'}$ below the lowest voltage necessary for the IC will cause ripple, deterioration in output regulation and, in certain circumstances, parasitic oscillation.

To determine the resistance value of R_{SD} , design with a margin, referring to the following equation.

$$R_{SD} < \frac{V_{IN} - V_{IN'}}{I_{OUT} + I_B}$$

- (4) Be sure to connect a capacitor near the input terminal and output terminal between both terminals and GND. The capacitances should be determined experimentally because they depend on PCB patterns. In particular, adequate investigation should be made to ensure there is no problem even in high or low temperatures

Application Circuits

(1) Voltage boost regulator

(a) Voltage boost by use of zener diode

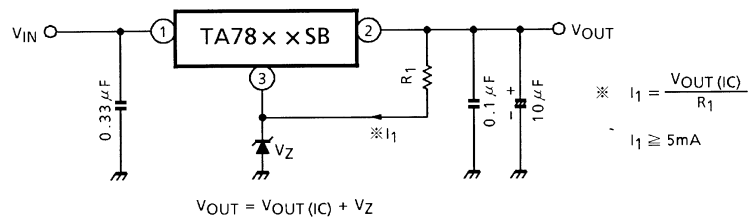

(b) Voltage boost by use of resistor

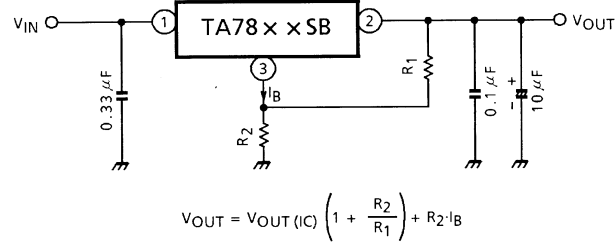

(c) Adjustable output regulator

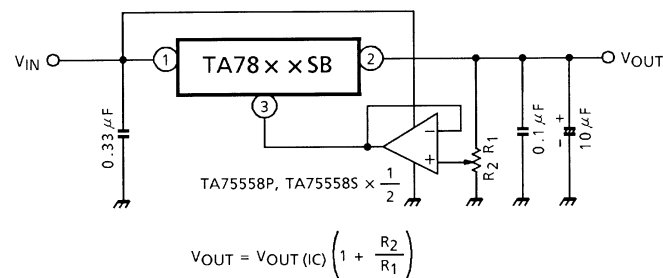

(2) Current boost regulator

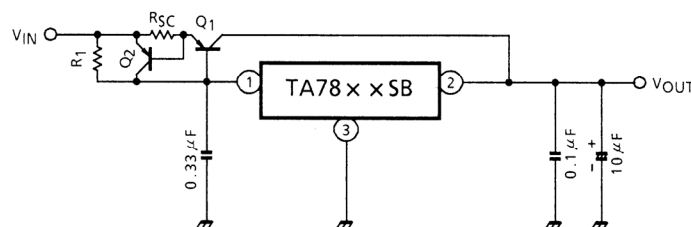

Heat sink is needed for Q1.

$$R_1 \approx \frac{V_{BE1}}{I_B \text{ MAX}}$$

where,

V_{BE1} : V_{BE} of external transistor Q1.

$I_B \text{ MAX}$: Quiescent current of IC.

$$R_{SC} = \frac{V_{BE2}}{I_{SC}}$$

where,

I_{SC} : Short-circuit current.

Package Dimensions

SIP3-P-2.50A

Unit : mm

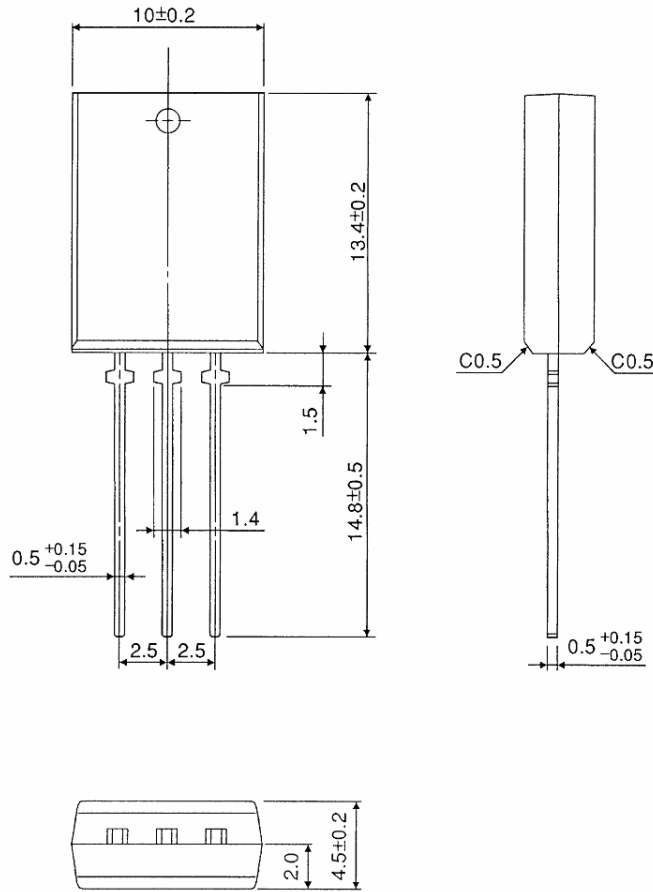

Weight: 1.5 g (typ.)

RESTRICTIONS ON PRODUCT USE

060925EBA

- The information contained herein is subject to change without notice. 021023_D
- TOSHIBA is continually working to improve the quality and reliability of its products. Nevertheless, semiconductor devices in general can malfunction or fail due to their inherent electrical sensitivity and vulnerability to physical stress. It is the responsibility of the buyer, when utilizing TOSHIBA products, to comply with the standards of safety in making a safe design for the entire system, and to avoid situations in which a malfunction or failure of such TOSHIBA products could cause loss of human life, bodily injury or damage to property.
In developing your designs, please ensure that TOSHIBA products are used within specified operating ranges as set forth in the most recent TOSHIBA products specifications. Also, please keep in mind the precautions and conditions set forth in the "Handling Guide for Semiconductor Devices," or "TOSHIBA Semiconductor Reliability Handbook" etc. 021023_A
- The TOSHIBA products listed in this document are intended for usage in general electronics applications (computer, personal equipment, office equipment, measuring equipment, industrial robotics, domestic appliances, etc.). These TOSHIBA products are neither intended nor warranted for usage in equipment that requires extraordinarily high quality and/or reliability or a malfunction or failure of which may cause loss of human life or bodily injury ("Unintended Usage"). Unintended Usage include atomic energy control instruments, airplane or spaceship instruments, transportation instruments, traffic signal instruments, combustion control instruments, medical instruments, all types of safety devices, etc. Unintended Usage of TOSHIBA products listed in this document shall be made at the customer's own risk. 021023_B
- The products described in this document shall not be used or embedded to any downstream products of which manufacture, use and/or sale are prohibited under any applicable laws and regulations. 060106_Q
- The information contained herein is presented only as a guide for the applications of our products. No responsibility is assumed by TOSHIBA for any infringements of patents or other rights of the third parties which may result from its use. No license is granted by implication or otherwise under any patent or patent rights of TOSHIBA or others. 021023_C
- The products described in this document are subject to foreign exchange and foreign trade control laws. 060925_E