

### 2 mode Noise Filters

Type: **EXC24CB/CP**  
**EXC24CN**



#### ■ Features

- Burst/radiation noise filtering for audio circuits
- The optimally magnetic-coupled ferrite beads allow for the filtering of both common and normal mode noises
- The strong multi-layer structure provides high resistance to reflow soldering heat and a high mounting reliability
- Magnetic shield type
- High Impedance : 220 to 1 kΩ (EXC24CB type)
- Low Resistance Value : 0.4 Ω max. (EXC24CP type)
- High Impedance : 600 Ω,  
Low Resistance Value : 0.9 Ω max. (EXC24CN type)

#### ■ Recommended Applications

- Receiver lines, speaker lines, microphone lines and headset of mobile phones.
- Audio signal lines of Portable audio equipment, PCs, PDAs.

#### ■ Explanation of Part Numbers

##### ● EXC24CB/CP Type

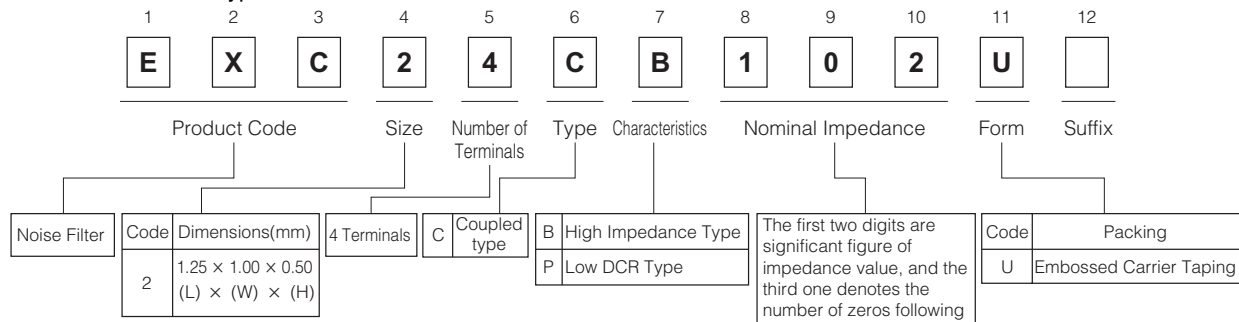

##### ● EXC24CN Type

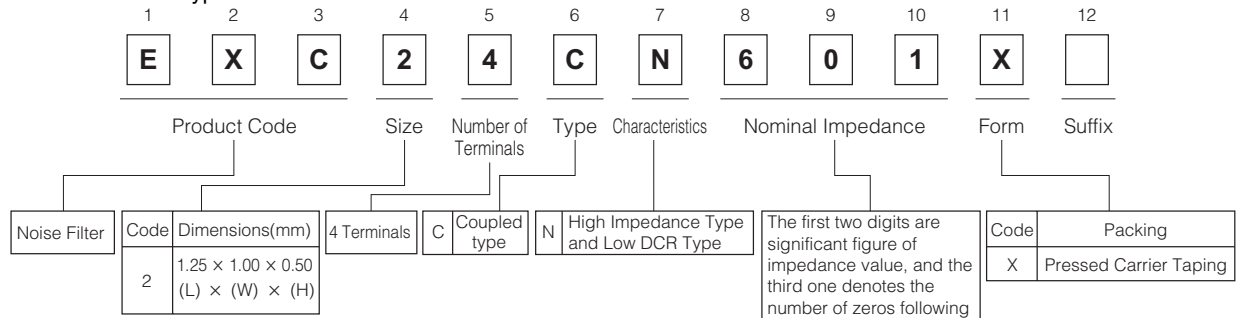

#### ■ Construction

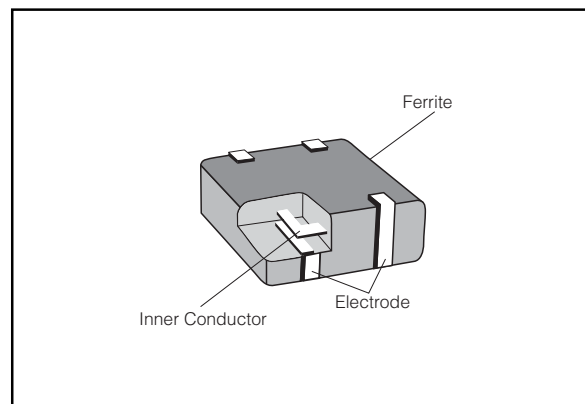

#### ■ Dimensions in mm (not to scale)

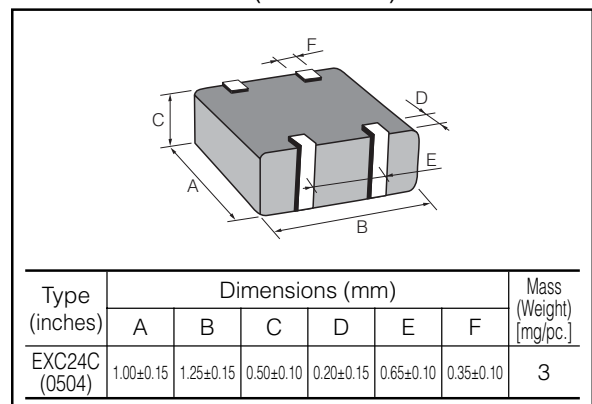

Design and specifications are each subject to change without notice. Ask factory for the current technical specifications before purchase and/or use. Should a safety concern arise regarding this product, please be sure to contact us immediately.

### ■ Circuit Configuration (No Polarity)

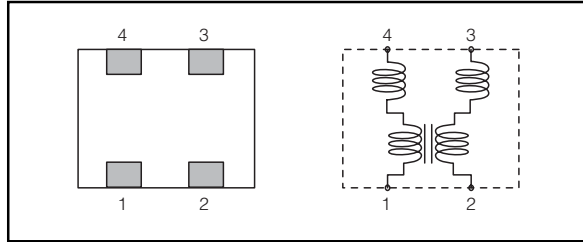

### ■ Ratings

Part Number	Impedance (Open mode)		Rated Voltage (V DC)	Rated Current (mA DC)	DC Resistance ( $\Omega$ ) max.
	( $\Omega$ ) at 100MHz	Tolerance(%)			
EXC24CP121U	120	$\pm 25$	5	500	0.3
EXC24CP221U	220			350	0.4
EXC24CB221U	220			100	0.7
EXC24CB102U	1000			50	1.5

Part Number	Impedance (Common mode)		Rated Voltage (V DC)	Rated Current (mA DC)	DC Resistance ( $\Omega$ ) max.
	( $\Omega$ ) at 100MHz	Tolerance(%)			
EXC24CN601X	600	$\pm 25$	5	200	0.9

### ■ Impedance Characteristics (Typical)

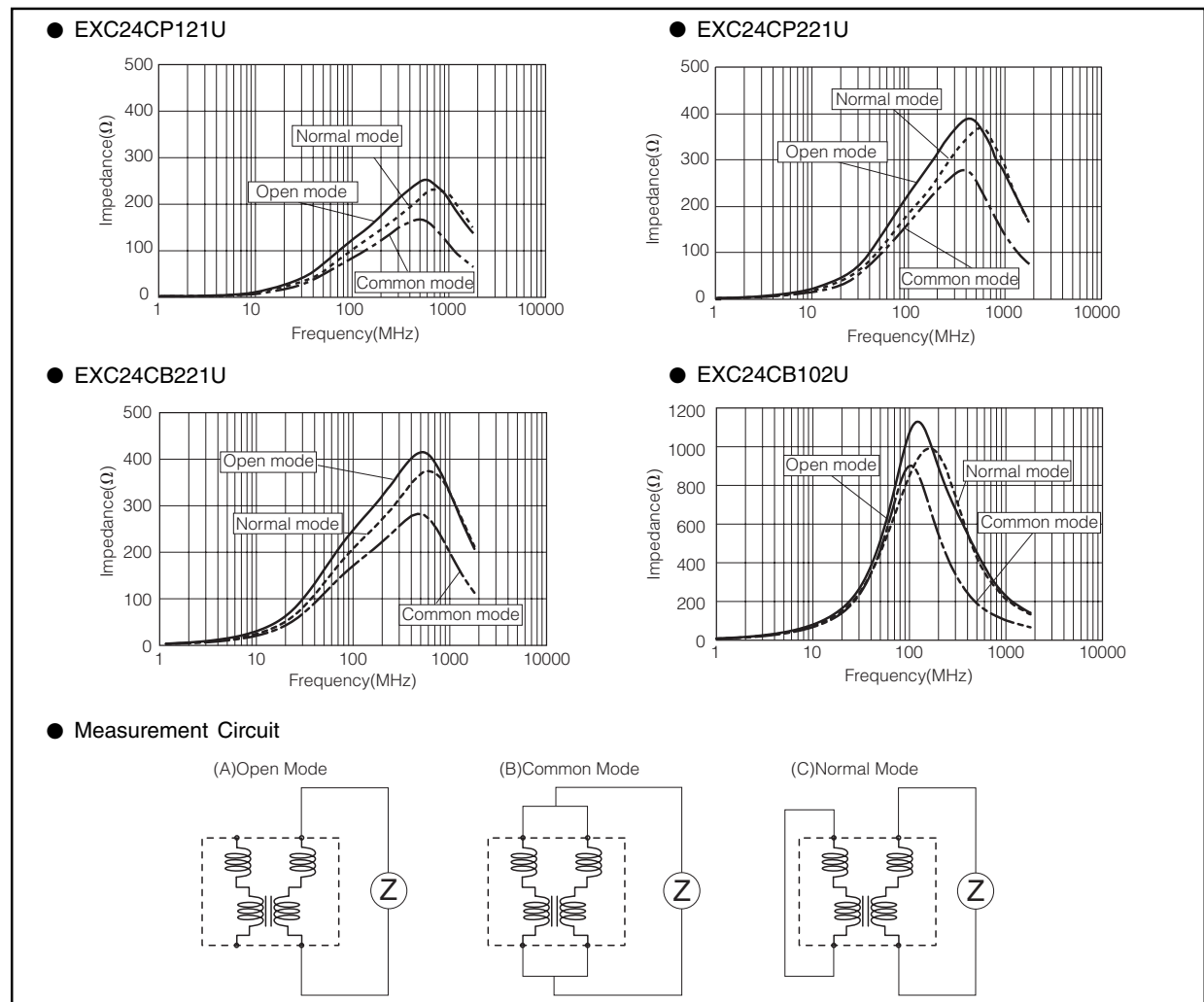

Design and specifications are each subject to change without notice. Ask factory for the current technical specifications before purchase and/or use. Should a safety concern arise regarding this product, please be sure to contact us immediately.

### Impedance Characteristics (Typical)

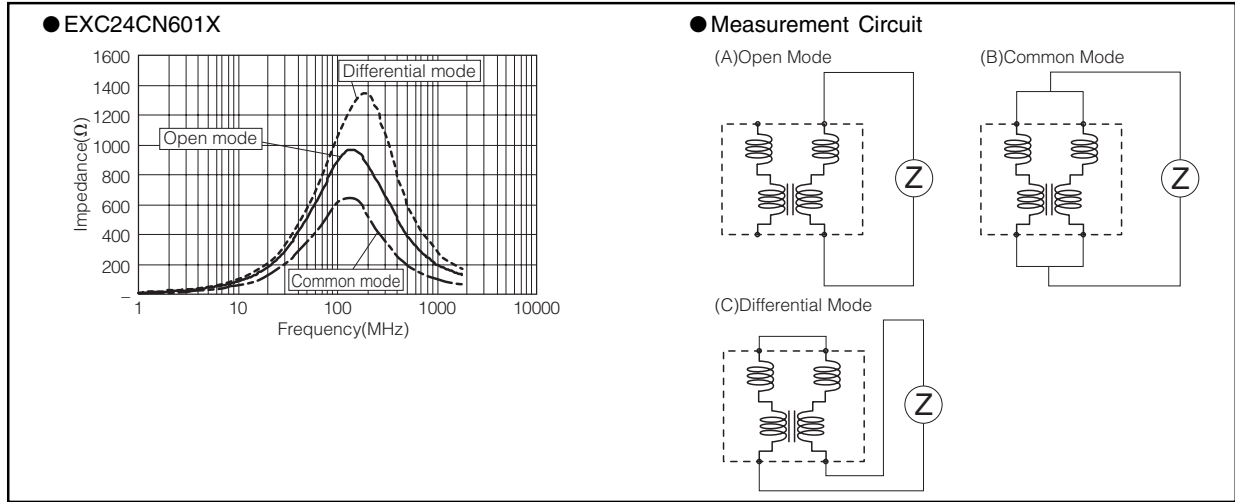

### Packaging Methods (Taping)

● Standard Quantity

Part Number	Kind of Taping	Pitch (P <sub>1</sub> )	Quantity
EXC24CP□□□□U	Embossed Carrier Taping	4 mm	5000 pcs./reel
EXC24CB□□□□U			
EXC24CN□□□□X	Pressed Carrier Taping	2 mm	10000 pcs./reel

#### Embossed Carrier Taping

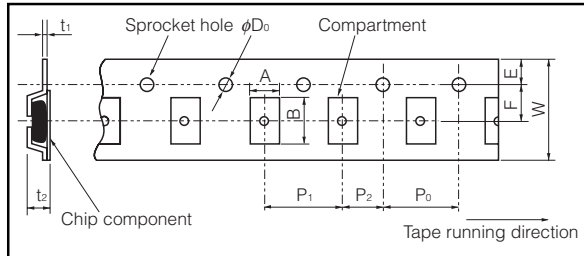

#### Pressed Carrier Taping

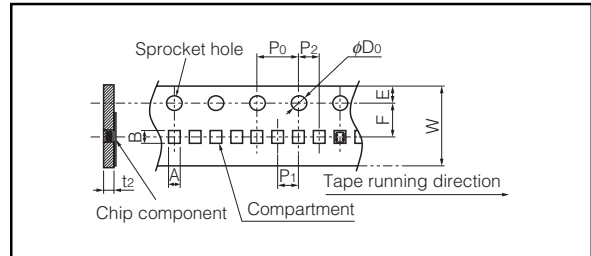

#### Taping Reel

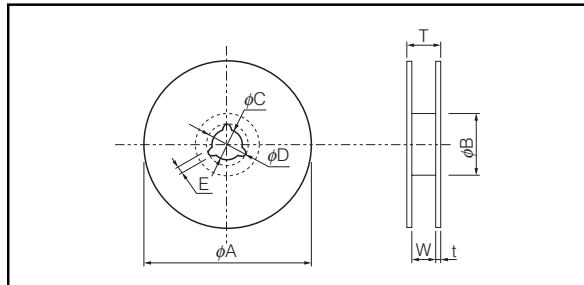

#### Embossed Carrier Dimensions (mm)

Part Number	A	B	W	F	E	P <sub>1</sub>	P <sub>2</sub>	P <sub>0</sub>	φD <sub>0</sub>	t <sub>1</sub>	t <sub>2</sub>
EXC24CP□□□□U	1.20±0.15	1.45±0.15	8.0±0.2	3.5±0.1	1.75±0.10	4.0±0.1	2.0±0.1	4.0±0.1	1.5±0.1	0.25±0.05	0.90±0.15
EXC24CB□□□□U											

#### Pressed Carrier Dimensions (mm)

Part Number	A	B	W	F	E	P <sub>1</sub>	P <sub>2</sub>	P <sub>0</sub>	φD <sub>0</sub>	t <sub>2</sub>
EXC24CN□□□□X	1.20±0.15	1.45±0.15	8.0±0.2	3.5±0.1	1.75±0.10	2.0±0.1	2.0±0.1	4.0±0.1	1.5±0.1	0.68±0.10

#### Standard Reel Dimensions (mm)

Part Number	φA	φB	φC	φD	E	W	T	t
EXC24C□□□□U	180.0±3.0	60.0±1.0	13.0±0.5	21.0±0.8	2.0±0.5	9.0±0.3	11.4±1.5	1.2±0.2

Design and specifications are each subject to change without notice. Ask factory for the current technical specifications before purchase and/or use. Should a safety concern arise regarding this product, please be sure to contact us immediately.

### Recommended Land Pattern Design

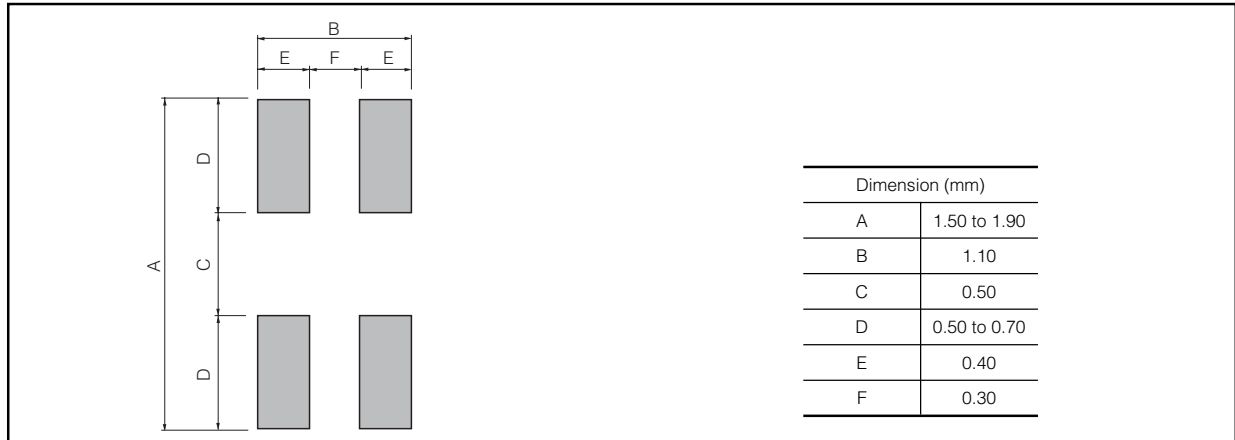

### Recommended Soldering Conditions

Recommendations and precautions are described below.

#### Recommended soldering conditions for reflow

- Reflow soldering shall be performed a maximum of two times.
- Please contact us for additional information when used in conditions other than those specified.
- Please measure the temperature of the terminals and study every kind of solder and printed circuit board for solderability before actual use.

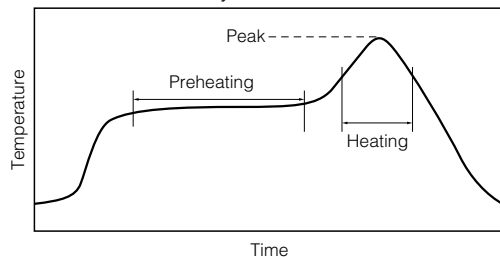

For soldering (Example : Sn-37Pb)

	Temperature	Time
Preheating	140 °C to 160 °C	60 s to 120 s
Main heating	Above 200 °C	30 s to 40 s
Peak	235 ± 10 °C	max. 10 s

For lead-free soldering (Example : Sn/3Ag/0.5Cu)

	Temperature	Time
Preheating	150 °C to 170 °C	60 s to 120 s
Main heating	Above 230 °C	30 s to 40 s
Peak	max. 260 °C	max. 10 s

<Repair with hand soldering>

- Preheat with a blast of hot air or similar method. Use a soldering iron with a tip temperature of 350 °C or less. Solder each electrode for 3 seconds or less.
- Never touch this product with the tip of a soldering iron.

### ⚠ Safety Precautions

The following are precautions for individual products. Please also refer to the precautions common to EMI Filters, ESD Suppressors, Fuses, and MR Sensors shown on page EL113 of this catalog.

1. When possible, do not mount 2 mode Noise Filters (hereafter called the filters) by flow soldering. It is highly possible that flow soldering may cause bridges between the electrodes.
2. Use rosin-based flux or halogen-free flux.
3. For cleaning, use an alcohol-based cleaning agent. Before using any other type, consult with our sales person in advance.
4. Do not apply shock to the filters or pinch them with a hard tool (e.g. pliers and tweezers). Otherwise, their bodies may be chipped, affecting their performance. Excessive mechanical stress may damage the filters. Handle with care.
5. Store the filters in a location with a temperature ranging from -5 °C to +40 °C and a relative humidity of 40 % to 60 %, where there are no rapid changes in temperature or humidity.
6. Use the filters within half a year after the date of the outgoing inspection indicated on the packages.

## ⚠ Safety Precautions (Common precautions for EMI Filters, ESD Suppressors, Fuses, and MR Sensors)

- When using our products, no matter what sort of equipment they might be used for, be sure to make a written agreement on the specifications with us in advance. The design and specifications in this catalog are subject to change without prior notice.
- Do not use the products beyond the specifications described in this catalog.
- This catalog explains the quality and performance of the products as individual components. Before use, check and evaluate their operations when installed in your products.
- Install the following systems for a failsafe design to ensure safety if these products are to be used in equipment where a defect in these products may cause the loss of human life or other significant damage, such as damage to vehicles (automobile, train, vessel), traffic lights, medical equipment, aerospace equipment, electric heating appliances, combustion/gas equipment, rotating equipment, and disaster/crime prevention equipment.
  - \* Systems equipped with a protection circuit and a protection device
  - \* Systems equipped with a redundant circuit or other system to prevent an unsafe status in the event of a single fault

### (1) Precautions for use

- These products are designed and manufactured for general and standard use in general electronic equipment (e.g. AV equipment, home electric appliances, office equipment, information and communication equipment)
- These products are not intended for use in the following special conditions. Before using the products, carefully check the effects on their quality and performance, and determine whether or not they can be used.
  1. In liquid, such as water, oil, chemicals, or organic solvent
  2. In direct sunlight, outdoors, or in dust
  3. In salty air or air with a high concentration of corrosive gas, such as Cl<sub>2</sub>, H<sub>2</sub>S, NH<sub>3</sub>, SO<sub>2</sub>, or NO<sub>2</sub>
  4. Electric Static Discharge (ESD) Environment (except ESD Suppressors)
    - These components are sensitive to static electricity and can be damaged under static shock (ESD). Please take measures to avoid any of these environments.
    - Smaller components are more sensitive to ESD environment.
  5. Electromagnetic Environment
    - Avoid any environment where strong electromagnetic waves exist.
  6. In an environment where these products cause dew condensation
  7. Sealing or coating of these products or a printed circuit board on which these products are mounted, with resin or other materials
- These products generate Joule heat when energized. Carefully position these products so that their heat will not affect the other components.
- Carefully position these products so that their temperatures will not exceed the category temperature range due to the effects of neighboring heat-generating components. Do not mount or place heat-generating components or inflammables, such as vinyl-coated wires, near these products (except Thermal Cutoffs).
- Note that non-cleaning solder, halogen-based highly active flux, or water-soluble flux may deteriorate the performance or reliability of the products.
- Carefully select a flux cleaning agent for use after soldering. An unsuitable agent may deteriorate the performance or reliability. In particular, when using water or a water-soluble cleaning agent, be careful not to leave water residues. Otherwise, the insulation performance may be deteriorated.

### (2) Precautions for storage

The performance of these products, including the solderability, is guaranteed for a year from the date of arrival at your company, provided that they remain packed as they were when delivered and stored at a temperature of 5 °C to 35 °C and a relative humidity of 45 % to 85 %. (Micro Chip Fuses: Guaranteed for 6 months from the date of arrival at your company)

The performance of EMI Filters is guaranteed for 6 months or a year from the outgoing inspection date indicated on the packages, provided that they are stored at a temperature of -5 °C to +40 °C and a relative humidity of 40 % to 60 %. Check the guarantee period in the specifications. The performance of Thermal Cutoffs is guaranteed for a year from the outgoing inspection date indicated on the packages, provided that they are stored at a temperature of -10 °C to +40 °C and a relative humidity of 30 % to 75 %.

Even within the above guarantee periods, do not store these products in the following conditions. Otherwise, their electrical performance and/or solderability may be deteriorated, and the packaging materials (e.g. taping materials) may be deformed or deteriorated, resulting in mounting failures.

1. In salty air or in air with a high concentration of corrosive gas, such as Cl<sub>2</sub>, H<sub>2</sub>S, NH<sub>3</sub>, SO<sub>2</sub>, or NO<sub>2</sub>
2. In direct sunlight

### <Package markings>

Package markings include the product number, quantity, and country of origin. In principle, the country of origin should be indicated in English.

---