

OUTLINE DRAWING

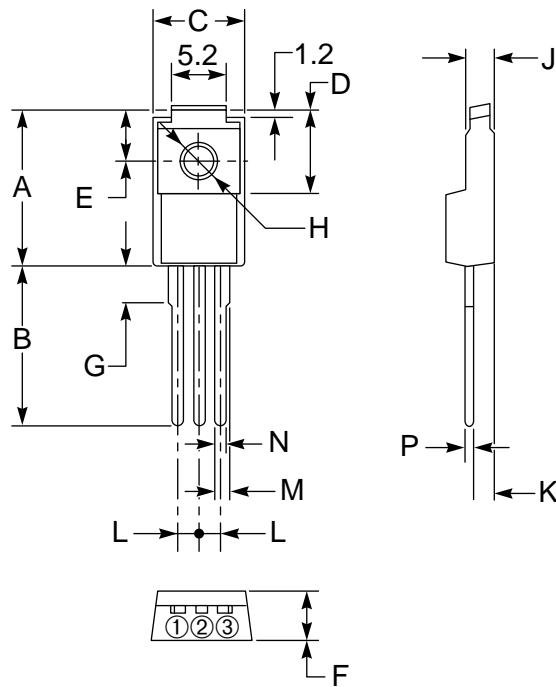

CONNECTION DIAGRAM

- ① T1 TERMINAL
- ② T2 TERMINAL
- ③ GATE TERMINAL

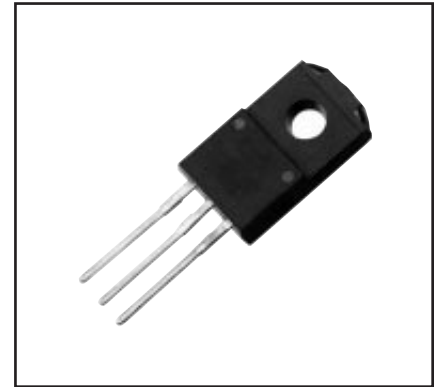
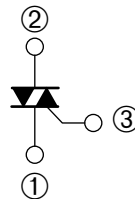

Description:

A triac is a solid state silicon AC switch which may be gate triggered from an off-state to an on-state for either polarity of applied voltage.

Features:

- Full Molded Isolation Package
- Glass Passivation
- Selected for Inductive Loads
- UL Approved

Applications:

- AC Switch
- Motor Controls
- Lighting

Ordering Information:

Example: Select the complete seven, eight or nine digit part number you desire from the table - i.e. BCR8PM-8 is a 400 Volt, 8 Ampere Triac.

Outline Drawing (Conforms to TO-220F)

Dimensions	Inches	Millimeters
A	0.67	17.0
B	0.49 Min.	12.5 Min.
C	0.39	10.0
D	0.33	8.5
E	0.20	5.0
F	0.18	4.5
G	0.14	3.6

Dimensions	Inches	Millimeters
H	0.126 ±0.008 Dia.	3.2 ±0.2 Dia.
J	0.11	2.8
K	0.102	2.6
L	0.10	2.5
M	0.039	1.0
N	0.031	0.8
P	0.020	0.5

Type	V _{DRM} Volts	Code	Inductive Load*
BCR8PM	400 600	-8 -12	L

*For inductive load, add L.

BCR8PM

Triac

8 Amperes/400-600 Volts

Absolute Maximum Ratings, $T_a = 25\text{ }^\circ\text{C}$ unless otherwise specified

Ratings	Symbol	BCR8PM-8	BCR8PM-12	Units
Repetitive Peak Off-state Voltage	V_{DRM}	400	600	Volts
Non-repetitive Peak Off-state Voltage	V_{DSM}	500	720	Volts
On-state Current, $T_c = 88^\circ\text{C}$	$I_T(\text{RMS})$	8	8	Amperes
Non-repetitive Peak Surge, One Cycle (60 Hz)	I_{TSM}	80	80	Amperes
I^2t for Fusing, $t = 8.3\text{ msec}$	I^2t	26	26	A^2sec
Peak Gate Power Dissipation, 20 μsec	P_{GM}	5	5	Watts
Average Gate Power Dissipation	$P_{G(\text{avg})}$	0.5	0.5	Watts
Peak Gate Current	I_{GM}	2	2	Amperes
Peak Gate Voltage	V_{GM}	10	10	Volts
Storage Temperature	T_{stg}	-40 to 125	-40 to 125	$^\circ\text{C}$
Operating Temperature	T_j	-40 to 125	-40 to 125	$^\circ\text{C}$
Isolation Voltage	V_{iso}	1500	1500	Volts
Weight	–	2	2	Grams

BCR8PM

Triac

8 Amperes/400-600 Volts

Electrical and Thermal Characteristics, $T_j = 25\text{ }^\circ\text{C}$ unless otherwise specified

Characteristics	Symbol	Test Conditions (Trigger Mode)				BCR8PM			Units
		V_D	R_L	R_G	T_j	Min.	Typ.	Max.	
Gate Parameters									
DC Gate Trigger Current									
MT2+ Gate+	I_{GT}	6V	6 Ω	330 Ω	25 $^\circ\text{C}$	–	–	30	mA
MT2+ Gate–		6V	6 Ω	330 Ω	25 $^\circ\text{C}$	–	–	30	mA
MT2– Gate–		6V	6 Ω	330 Ω	25 $^\circ\text{C}$	–	–	30	mA
DC Gate Trigger Voltage									
MT2+ Gate+	V_{GT}	6V	6 Ω	330 Ω	25 $^\circ\text{C}$	–	–	1.5	Volts
MT2+ Gate–		6V	6 Ω	330 Ω	25 $^\circ\text{C}$	–	–	1.5	Volts
MT2– Gate–		6V	6 Ω	330 Ω	25 $^\circ\text{C}$	–	–	1.5	Volts
DC Gate Non-trigger Voltage									
All	V_{GD}	1/2 V_{DRM}	–	–	125 $^\circ\text{C}$	0.2	–	–	Volts

BCR8PM

Triac

8 Amperes/400-600 Volts

Electrical and Thermal Characteristics, $T_j = 25\text{ }^\circ\text{C}$ unless otherwise specified

Characteristics	Symbol	Test Conditions	Min.	Typ.	Max.	Units
Thermal Resistance, Junction-to-case	$R_{th(j-c)}$	–	–	–	3.7	$^\circ\text{C/W}$
Voltage – Blocking State Repetitive Off-state Current	I_{DRM}	Gate Open Circuited, $V_D = V_{DRM}$, $T_j = 125^\circ\text{C}$	–	–	2	mA
Current – Conducting State Peak On-state Voltage	V_{TM}	$T_C = 25^\circ\text{C}$ $I_{TM} = 12\text{A}$	–	–	1.6	Volts
Critical Rate-of-rise of Commutating Off-state Voltage (Commutating dv/dt) ▲ for inductive load (L) (Switching)	$(dv/dt)_C$	–	–	–	–	$\text{V}/\mu\text{s}$

Δ Part Number	V_{DRM} (Volts)	Commutating dv/dt , $(dv/dt)_C$ ($\text{V}/\mu\text{sec}$)		Test Condition	Commutating Voltage & Current Waveform (Inductive Load)
		Load Type	Minimum		
BCR8PM-8L	400	L	10	$T_j = 125^\circ\text{C}$, Rate of Decay On-state Commutating Current $(di/dt)_C = -4\text{A/msec}$; Peak Off-state Voltage $V_D = 400\text{V}$	
BCR8PM-12L	600	L	10		

BCR8PM

Triac

8 Amperes/400-600 Volts

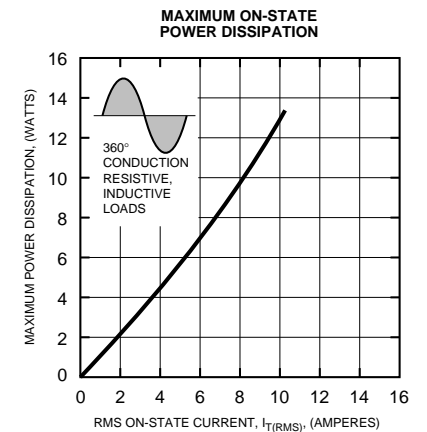
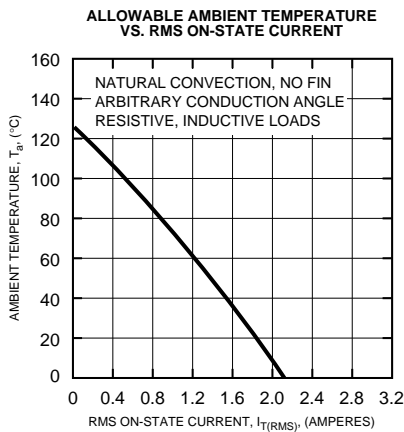
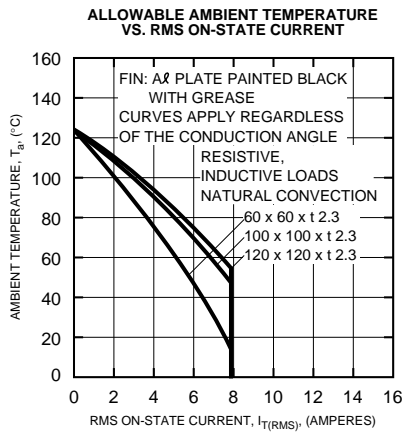
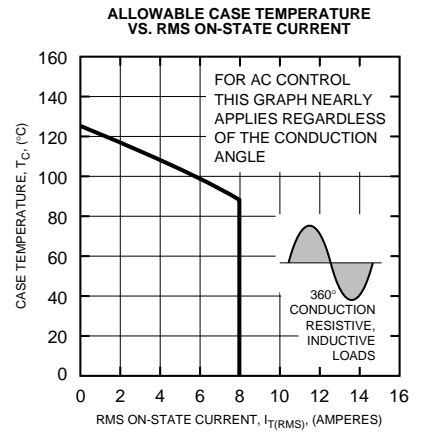
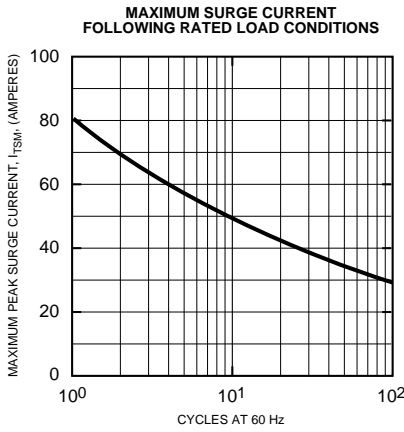
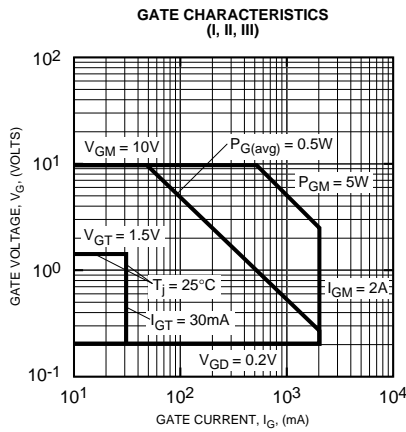
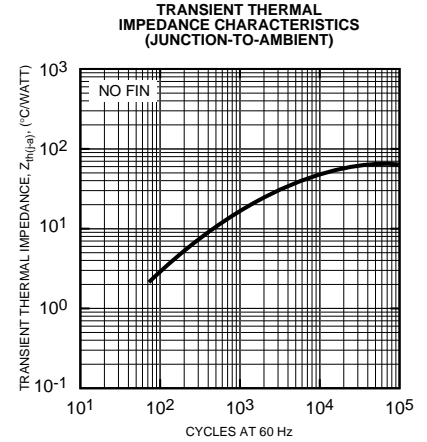
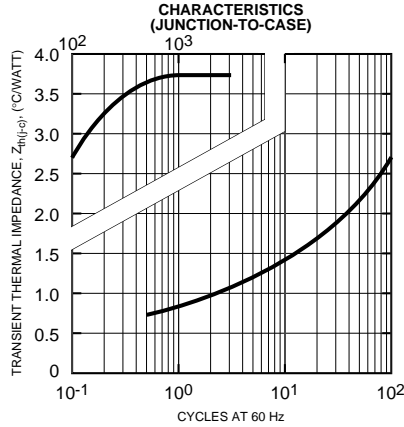
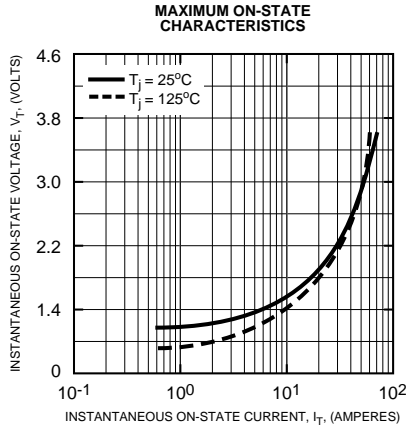

BCR8PM

Triac

8 Amperes/400-600 Volts

GATE TRIGGER CURRENT VS. JUNCTION TEMPERATURE (TYPICAL)

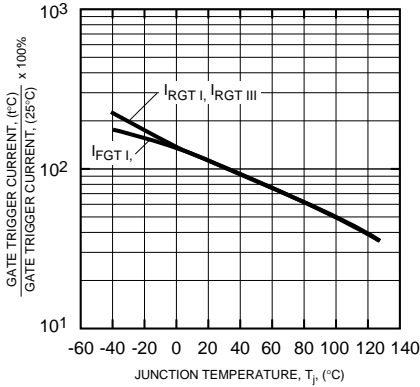

GATE TRIGGER VOLTAGE VS. JUNCTION TEMPERATURE (TYPICAL)

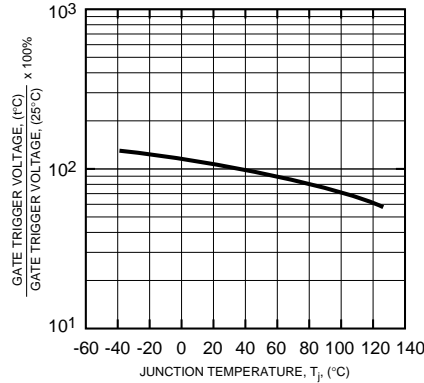

LATCHING CURRENT VS. JUNCTION TEMPERATURE (TYPICAL)

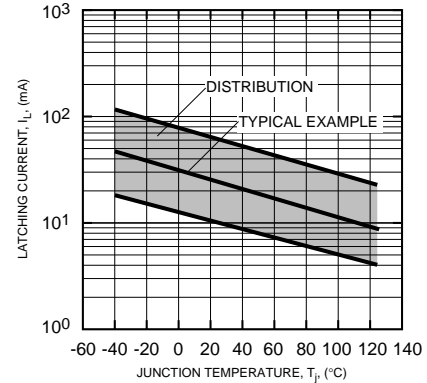

BREAKOVER VOLTAGE VS. JUNCTION TEMPERATURE (TYPICAL)

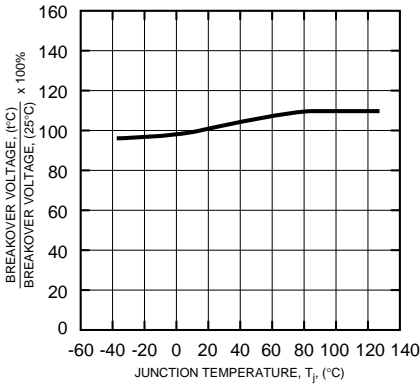

BREAKOVER VOLTAGE VS. RATE OF RISE OF OFF-STATE VOLTAGE (TYPICAL)

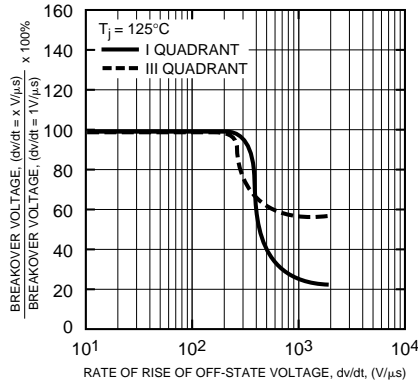

REPETITIVE PEAK OFF-STATE CURRENT VS. JUNCTION TEMPERATURE (TYPICAL)

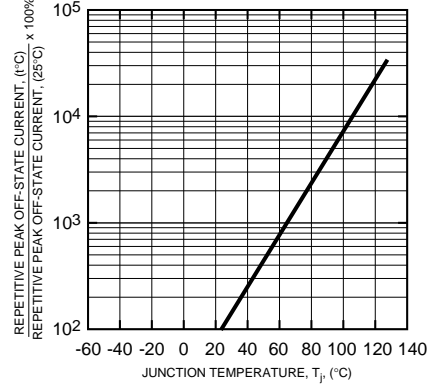

COMMUTATION CHARACTERISTICS (TYPICAL)

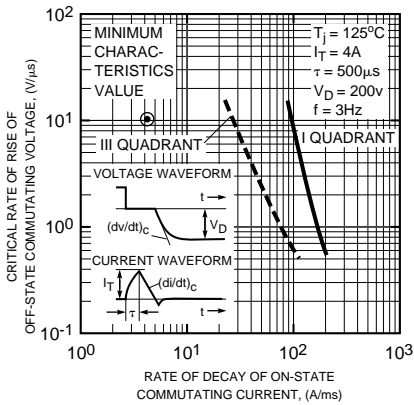

GATE TRIGGER CURRENT VS. GATE CURRENT PULSE WIDTH (TYPICAL)

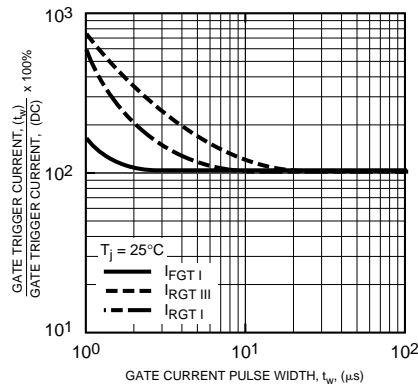

GATE TRIGGER CHARACTERISTICS TEST CIRCUITS

