

POWER RELAY

1 POLE—10 A LOW PROFILE TYPE FTR-H1 SERIES

RoHS compliant

■ FEATURES

- Working class: B (for IMQ)/ C (for VDE)
- Type of service: continuous duty
- Low profile (height 16.5 mm)/ cadmium free contacts
- 1 form A/ 1 form C 10 A, TV-5 rating available
- UL class B (130°C) insulation
- High isolation in small package (between coil and contacts)
 - Insulation distance : 8 mm
 - Dielectric strength : 5,000 VAC
 - Surge strength : 10,000 V
- Plastic materials —UL94 flame class V-0
UL CTI level class 2
- Plastic sealed relay
- Pin configuration compatible to VS/ FBR610 Series
- UL, CSA, BSI, VDE, SEMKO recognized
- Conforms to FIMKO, DEMKO
- Environmentally friendly cadmium free contacts type are available
- RoHS compliant since date code: 0434R
Please see page 7 for more information



■ ORDERING INFORMATION

[Example] $\frac{\text{FTR-H1}}{\text{(a)}} \quad \frac{\text{A}}{\text{(b)}} \quad \frac{\text{A}}{\text{(c)}} \quad \frac{\text{005}}{\text{(d)}} \quad \frac{\text{V}}{\text{(e)}} \quad \frac{\text{- **}}{\text{(f)}}$

(a)	Series Name	FTR-H1: FTR-H1 Series			
(b)	Contact Arrangement	A	: 1 form A (SPST-NO)		
		C	: 1 form C (SPDT)		
(c)	Coil Type	A	: Standard type (0.53 W)		
		D	: High sensitive type (0.4W)		
(d)	Nominal Voltage	005	: 5 VDC	012	: 12 VDC
		006	: 6 VDC	024	: 24 VDC
		009	: 9 VDC	048	: 48 VDC
(e)	Contact Material/TV Type	V	: Gold plate silver alloy (standard type)		
		T	: Gold plate silver alloy (TV-5 rating type, 1 form A standard type only)		
(f)	Custom Designation	Custom specification to be assigned			

Ordering Code Actual Marking
FTR-H1AA005V H1AA005V

FTR-H1 SERIES

n SAFETY STANDARD AND FILE NUMBERS

UL508, 873 (File No. E63614)

C22.2 No. 14 (File No. LR40304-30/LR107822)

VDE 0435, 0631, 0700, 0860 (File No. 11039-4940-1019)

	Nominal voltage	Contact rating
TV-Rating	5 ~ 48 VDC	TV-5 120 VAC 1/2 HP 250 VAC 1/3 HP 125 VAC 10 A 30 VDC/250 VAC resistive Pilot duty B 300, Q 300
General		1/2 HP 250 VAC 1/3 HP 125 VAC 10 A 30 VDC/250 VAC resistive 3A 250 VAC inductive (PF=0.4) Pilot duty B 300, Q 300

FTR-H1 SERIES

■ SPECIFICATIONS

Item		Standard Type	Sensitive	TV-5 Rating Type
Contact	Arrangement	1 form A (SPST-NO), 1 form C (SPDT)		1 form A (SPST-NO)
	Material	Gold plate silver alloy		
	Style	Single		
	Resistance (initial)	Maximum 100 m Ω (at 1 A 6 VDC)		
	Rating (Resistive)	10 A 250 VAC/30 VDC		
	Maximum Carrying Current	14 A		
	Maximum Switching Rating	2,500 VA/300 W		
	Maximum Switching Voltage	400 VAC 300 VDC		
	Maximum Switching Current	10 A		
	Minimum Switching Load*1	10 mA 5 VDC		
	Maximum Inrush Current	—		78 A 120 VAC (at lamp load)
Coil	Operating Range	80 to 110 % × V nominal		
	Nominal Power (at 20°C)	0.53 W	0.4W	0.53 W
	Operate Power (at 20°C)	0.26 W	0.225W	0.26W
	Operating Temperature	-40°C to +75°C (no frost) (refer to the CHARACTERISTIC DATA)		
Time Value	Operate (at nominal voltage)	Maximum 10 ms		
	Release (at nominal voltage)	Maximum 5 ms		
Insulation	Resistance (at 500 VDC)	Minimum 1,000 M Ω		
	Dielectric Strength	Between open contacts	1,000 VAC 1 minute	
		Between coil and contacts*2	5,000 VAC 1 minute	
Surge Strength*3	10,000 V (at 1.2 x 50 μs)			
Life	Mechanical	2 × 10 ⁷ operations minimum		
	Electrical	Contact Rating	1 × 10 ⁵ operations minimum	
		Lamp Load	—	
Other	Vibration Resistance	Misoperation	10 to 55 Hz (double amplitude of 1.65 mm)	
		Endurance	10 to 55 Hz (double amplitude of 3.3 mm)	
	Shock Resistance	Misoperation	100 m/s ² (11 ± ¹ ms)	
		Endurance	1,000 m/s ² (6 ± ¹ ms)	
	Weight	Approximately 12 g		

*1 Minimum switching loads mentioned above are reference values. Please perform the confirmation test with the actual load before production since reference values may vary according to switching frequencies, environmental conditions and expected reliability levels.

*2 IMQ

*3 IMQ

FTR-H1 SERIES

■ COIL DATA CHART

MODEL		Nominal Voltage	Coil Resistance (±10%)	Must Operate Voltage	Must Release Voltage
Standard Type	TV-5 Rating Type				
FTR-H1 (C, A) A005 V	FTR-H1AA005 T	5 VDC	47 Ω	3.5 VDC	0.5 VDC
FTR-H1 (C, A) A006V	FTR-H1AA006 T	6 VDC	68 Ω	4.2 VDC	0.6 VDC
FTR-H1 (C, A) A009 V	FTR-H1AA009 T	9 VDC	155 Ω	6.3 VDC	0.9 VDC
FTR-H1 (C, A) A012 V	FTR-H1AA012 T	12 VDC	270 Ω	8.4 VDC	1.2 VDC
FTR-H1 (C, A) A024 V	FTR-H1AA024 T	24 VDC	1,100 Ω	16.8 VDC	2.4 VDC
FTR-H1 (C, A) A048 V	FTR-H1AA048 T	48 VDC	4,400 Ω	33.6 VDC	4.8 VDC

Note: All values in the table are measured at 20°C.

Sensitive Type

MODEL		Nominal Voltage	Coil Resistance (±10%)	Must Operate Voltage	Must Release Voltage
Standard Type					
FTR-H1 (C, A) D005 V		5 VDC	62 Ω	3.75 VDC	0.5 VDC
FTR-H1 (C, A) D006 V		6 VDC	90 Ω	4.5 VDC	0.6 VDC
FTR-H1 (C, A) D009V		9 VDC	202 Ω	6.75 VDC	0.9 VDC
FTR-H1 (C, A) D012 V		12 VDC	360 Ω	9.0 VDC	1.2 VDC
FTR-H1 (C, A) D024 V		24 VDC	1,440 Ω	18.0 VDC	2.4 VDC
FTR-H1 (C, A) D048 V		48 VDC	5,760 Ω	36.0 VDC	4.8 VDC

Note: All values in the table are measured at 20°C.

FTR-H1 SERIES

CHARACTERISTIC DATA

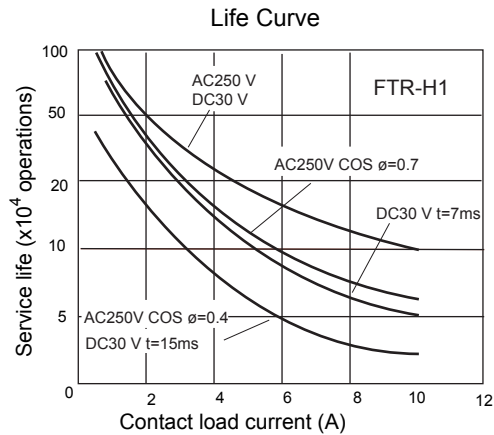
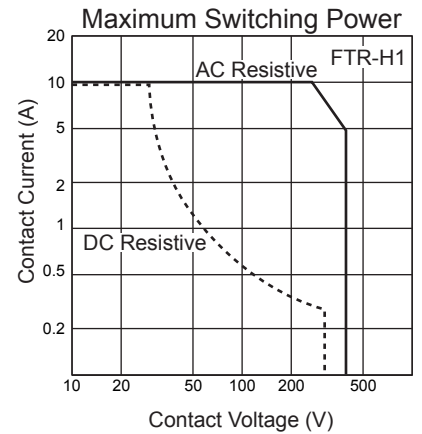
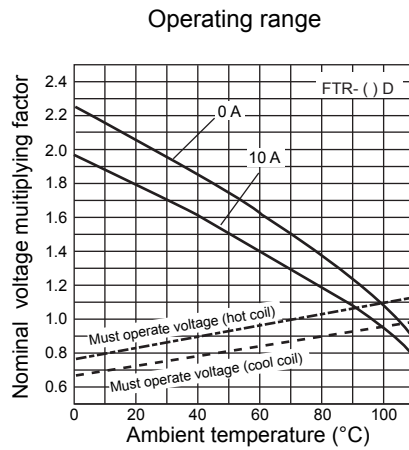
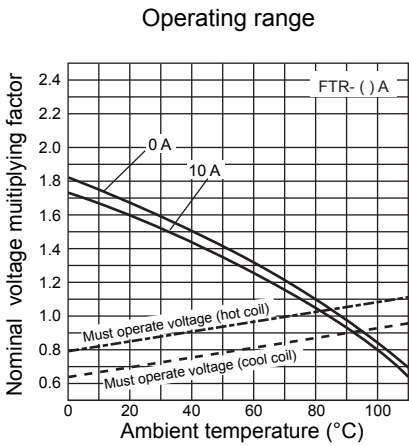
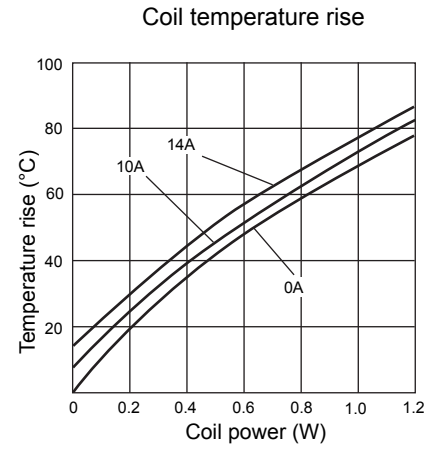
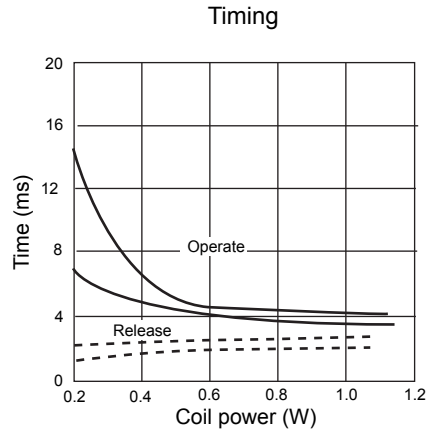
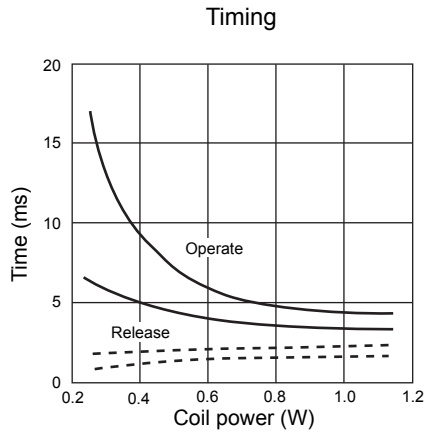

REFERENCE DATA

Distribution of operate and release voltage

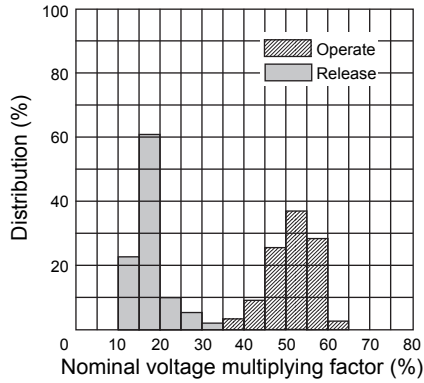

Distribution of operate and release time

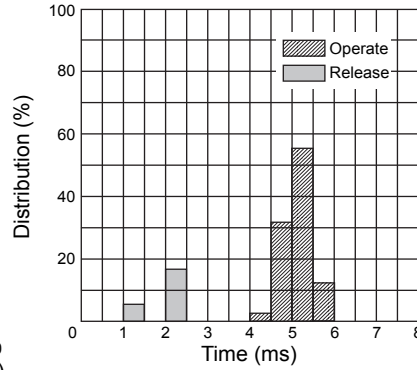

Distribution of contact resistance

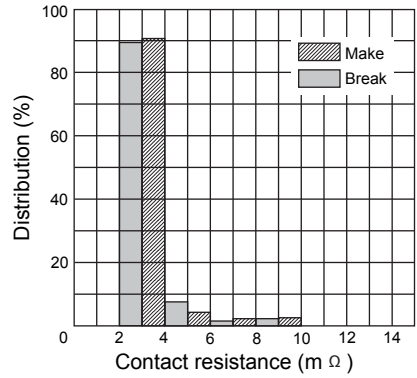

Mechanical life test

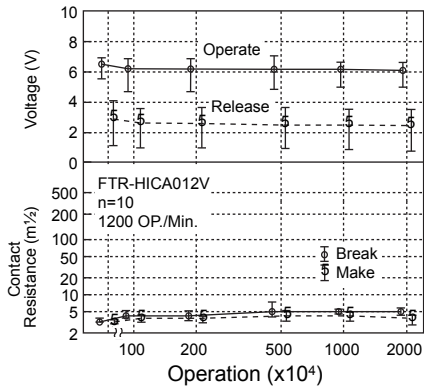

Electrical life test

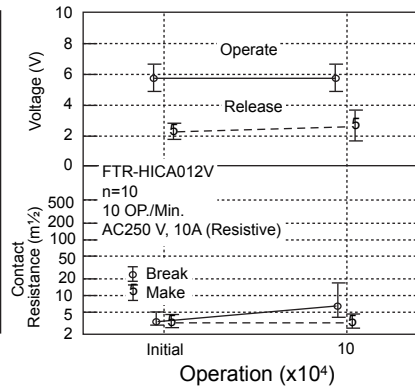

Electrical life test

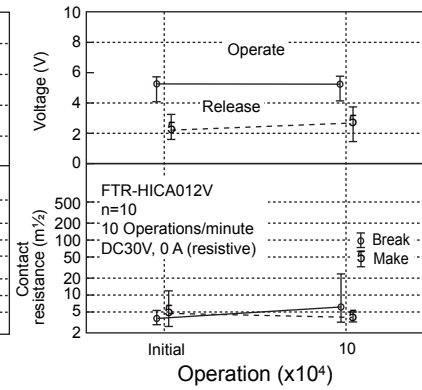

DIMENSIONS

Dimensions

FTR-H1A type

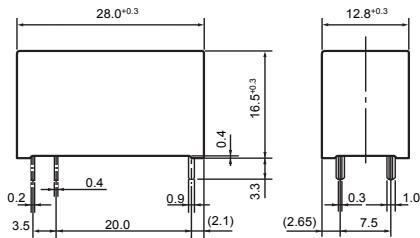

FTR-H1C type

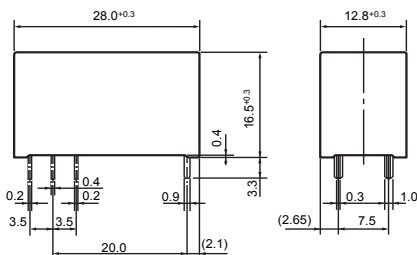

Schematics (BOTTOM VIEW)

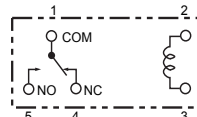
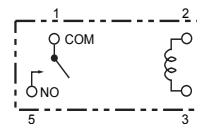

PC board mounting hole layout (BOTTOM VIEW)

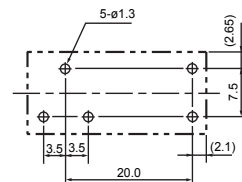
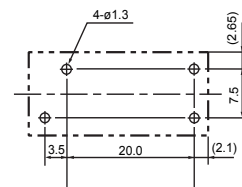

Unit: mm

RoHS Compliance and Lead Free Relay Information

1. General Information

- Relays produced after the specific date code that is indicated on each data sheet are lead-free now. Most of our signal and power relays are lead-free. Please refer to Lead-Free Status Info. (<http://www.fujitsu.com/us/downloads/MICRO/fcai/relays/lead-free-letter.pdf>)
- Lead free solder paste currently used in relays is Sn-3.0Ag-0.5Cu.
- All signal and most power relays also comply with RoHS. Please refer to individual data sheets. Relays that are RoHS compliant do not contain the 5 hazardous materials that are restricted by RoHS directive (lead, mercury, chromium IV, PBB, PBDE).
- It has been verified that using lead-free relays in leaded assembly process will not cause any problems (compatible).
- "LF" is marked on each outer and inner carton. (No marking on individual relays).
- To avoid leaded relays (for lead-free sample, etc.) please consult with area sales office.
- We will ship leaded relays as long as the leaded relay inventory exists.

Note: Cadmium was exempted from RoHS on October 21, 2005. (Amendment to Directive 2002/95/EC)

2. Recommended Lead Free Solder Profile

- Recommended solder paste Sn-3.0Ag-0.5Cu.

Reflow Solder condition

Flow Solder condition:

Pre-heating: maximum 120°C
Soldering: dip within 5 sec. at
260°C solder bath

Solder by Soldering Iron:

Soldering Iron
Temperature: maximum 360°C
Duration: maximum 3 sec.

We highly recommend that you confirm your actual solder conditions

3. Moisture Sensitivity

Moisture Sensitivity Level standard is not applicable to electromechanical relays.

4. Tin Whisker

- Dipped SnAgCu solder is known as low risk tin whisker. No considerable length whisker was found by our in house test.

Fujitsu Components International Headquarter Offices

Japan

Fujitsu Component Limited
Gotanda-Chuo Building
3-5, Higashigotanda 2-chome, Shinagawa-ku
Tokyo 141, Japan
Tel: (81-3) 5449-7010
Fax: (81-3) 5449-2626
Email: promothq@ft.ed.fujitsu.com
Web: www.fcl.fujitsu.com

North and South America

Fujitsu Components America, Inc.
250 E. Caribbean Drive
Sunnyvale, CA 94089 U.S.A.
Tel: (1-408) 745-4900
Fax: (1-408) 745-4970
Email: marcom@fcai.fujitsu.com
Web: <http://www.fujitsu.com/us/services/edevices/components/>

Europe

Fujitsu Components Europe B.V.
Diamantlaan 25
2132 WV Hoofddorp
Netherlands
Tel: (31-23) 5560910
Fax: (31-23) 5560950
Email: info@fceu.fujitsu.com
Web: <http://www.fujitsu.com/emea/services/components/>

Asia Pacific

Fujitsu Components Asia Ltd.
102E Pasir Panjang Road
#04-01 Citilink Warehouse Complex
Singapore 118529
Tel: (65) 6375-8560
Fax: (65) 6273-3021
Email: fcal@fcal.fujitsu.com
Web: <http://www.fujitsu.com/sg/services/micro/components/>

©2005 Fujitsu Components America, Inc. All rights reserved. All trademarks or registered trademarks are the property of their respective owners.

Fujitsu Components America does not warrant that the content of datasheet is error free. In a continuing effort to improve our products Fujitsu Components America, Inc. reserves the right to change specifications/datasheets without prior notice. Rev. 11/18/2005.