

FEATURES

- **CTR Minimum**
MCA230/255, 100%
MCA231, 200%
- **Isolation Test Voltage, 5300 VAC_{RMS}**
- **Coupling Capacitance, 0.5 pF**
- **Fast Rise Time, 10 μs**
- **Fast Fall Time, 35 μs**
- **Underwriters Lab File #E52744**
- **VDE #0884 Available with Option 1**

DESCRIPTION

The MCA230/231/255 are industry standard opto-couplers, consisting of a Gallium Arsenide infrared LED and a silicon photodarlington. These opto-couplers are constructed with a high voltage insulation, double molded packaging process which offers 7.5 KV withstand test capability.

Maximum Ratings

Emitter

Reverse Voltage	6 V
Continuous Forward Current	60 mA
Power Dissipation at 25°C	135 mW
Derate Linearly from 25°C	1.8 mW/°C
Detector	
Collector-Emitter Breakdown Voltage	
MCA230/231	30 V
MCA255	55 V
Emitter-Collector Breakdown Voltage	7 V
Collector-Base Breakdown Voltage	
MCA230/231	30 V
MCA255	55 V
Power Dissipation at 25°C	210 mW
Derate Linearly from 25°C	2.8 mW/°C

Package

Total Package Dissipation at 25°C	
(LED plus Detector)	260 mW
Derate Linearly from 25°C	3.5 mW/°C
Storage Temperature	-55°C to +150°C
Operating Temperature	-55°C to +100°C
Lead Soldering Time at 260°C	10 sec.
Isolation Test Voltage	5300 VAC _{RMS}
Isolation Resistance	
V _{IO} =500 V, T _A =25°C	10 ¹² Ω
V _{IO} =500 V, T _A =100°C	10 ¹¹ Ω

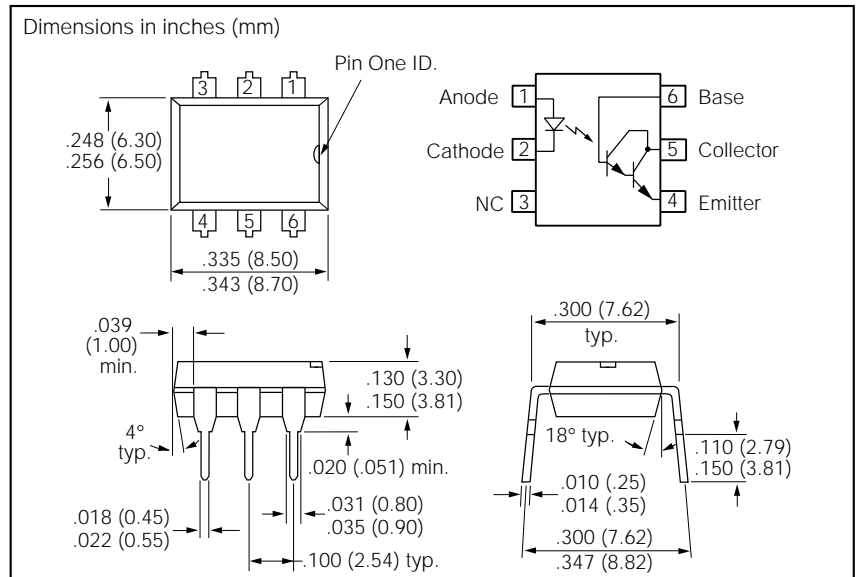

Characteristics (T_A=25°C)

	Symbol	Min.	Typ.	Max.	Unit	Condition
Emitter						
Forward Voltage	V _F		1.1	1.5	V	I _F =50 mA
Reverse Current	I _R			10	μA	V _R =3 V
Junction Capacitance	C _J		50		pF	V _R =3 V
Detector						
BV _{CEO}		30			V	I _C =100 μA, I _F =0 mA
MCA230/231		30			V	I _C =100 μA, I _F =0 mA
MCA255						
BV _{ECO}		7			V	I _E =10 μA, I _F =0 mA
BV _{CBO}		30			V	I _C =10 μA, I _F =0 mA
MCA230/231		55			V	I _C =10 μA, I _F =0 mA
MCA55						
I _{CEO}				100	nA	V _{CE} =10 V, I _F =0 mA
Package						
V _{CEsat}				0.8	V	I _{CE} =2 mA, I _F =16 mA
				1.0	V	I _C =I _F =50 mA
				1.0	V	I _C =2 mA, I _F =1 mA
				1.0	V	I _C =10 mA, I _F =5 mA
				1.2	V	I _C =50 mA, I _F =10 mA
DC Current Transfer Ratio					%	V _{CE} =5 V, I _F =10 mA
MCA230/255	CTR	100			%	V _{CE} =5 V, I _F =1 mA
MCA231	CTR	200			%	
Capacitance Input to Output	C _{IO}		0.5		pF	
Switching Times	t _{on}		10		μs	R _L =100 Ω
	t _{off}		35		μs	V _{CE} =10 V

Figure 1. Forward voltage versus forward current

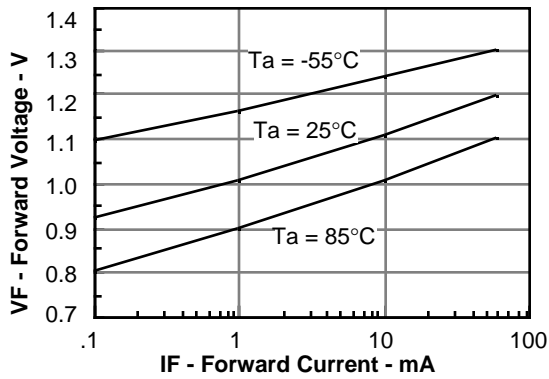

Figure 2. Normalized non-saturated and saturated CTRce at TA = 25°C versus LED current

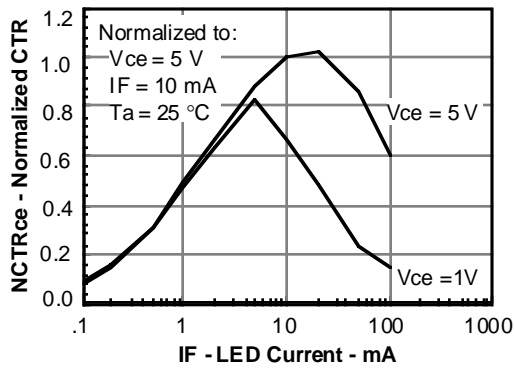

Figure 3. Normalized non-saturated and saturated collector-emitter current versus LED current

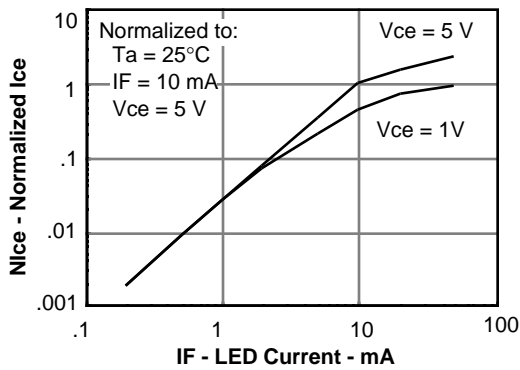

Figure 4. Normalized collector-base photocurrent versus LED current

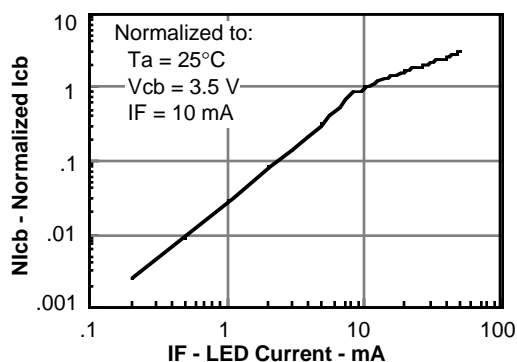

Figure 5. Non-saturated and saturated HFE versus base current

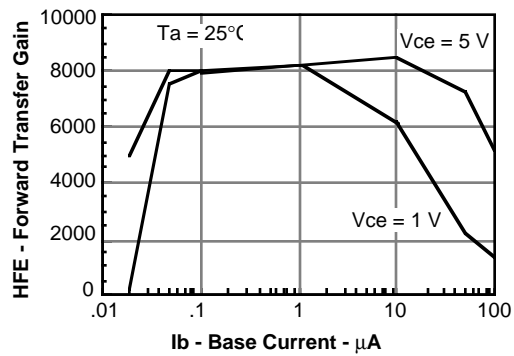

Figure 6. Low to high propagation delay versus collector load resistance and LED current

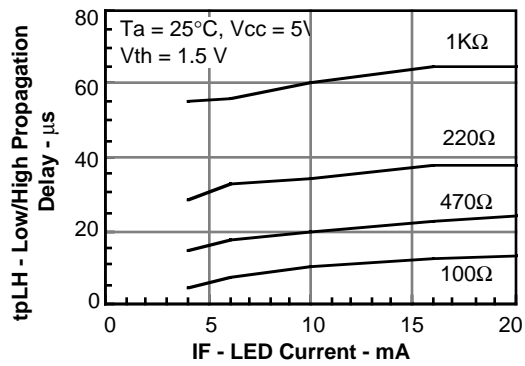

Figure 7. High to low propagation delay versus collector load resistance and LED current

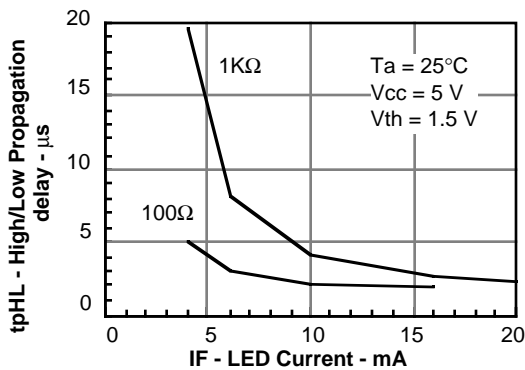

Figure 8. Switching timing waveform and schematic

