

Evaluation Kit Manual  
Follows Data Sheet

# MAXIM

## +12V, 120mA Flash Memory Programming Supply

MAX734

### General Description

The MAX734 is a +12V-output, step-up, DC-DC switch-mode regulator. It delivers a guaranteed 120mA from a 4.75V input, and is ideal for programming flash memories. Available in 8-pin SO and DIP packages, it uses only a diode, an 18 $\mu$ H inductor, and two 33 $\mu$ F capacitors. The entire circuit is completely surface-mountable and fits into less than 0.3in<sup>2</sup>. The MAX734 also features a logic-controlled shutdown pin that allows direct microprocessor ( $\mu$ P) control. In-circuit testing ensures guaranteed output specifications over load, line, and temperature limits.

Battery-saving features include 85% efficiency, 1.2mA operating quiescent supply current, and 70 $\mu$ A shutdown supply current. The operating supply current can be reduced to less than 500 $\mu$ A by toggling the shutdown pin with the  $\mu$ P.

The MAX734 uses current-mode pulse-width modulation (PWM) control to provide precise output regulation and low subharmonic noise. A fixed 170kHz oscillator frequency facilitates ripple filtering and allows the use of tiny external capacitors.

For higher-current solutions up to 250mA, refer to the MAX732 data sheet and evaluation kit (MAX732EVKIT-SO).

### Applications

- +12V Flash Memory Programming Supplies
- PCMCIA +12V Supplies
- Solid-State Disk Drives
- Palmtop Computers
- Compact +12V Op-Amp Supplies

### Pin Configuration

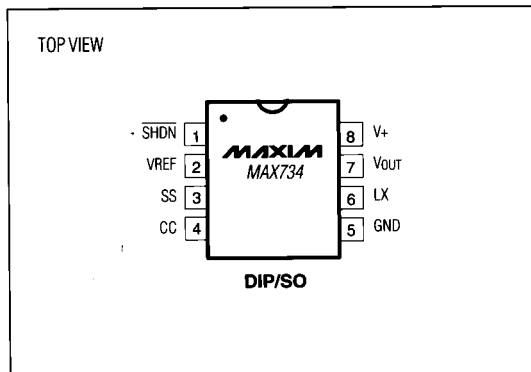

### Features

- ◆ Regulated +12V  $\pm$ 5% Output
- ◆ Guaranteed 120mA Output Current
- ◆ Tiny Flash Memory Programming Circuit:  
Fits into 0.3in<sup>2</sup>  
8-Pin SO and Plastic DIP Packages  
Uses Tiny 18 $\mu$ H Inductor and 33 $\mu$ F Capacitors
- ◆ Logic-Controlled 70 $\mu$ A Shutdown
- ◆ 85% Typical Efficiency

### Ordering Information

PART	TEMP. RANGE	PIN-PACKAGE
MAX734CPA	0°C to +70°C	8 Plastic DIP
MAX734CSA	0°C to +70°C	8 SO
MAX734C/D	0°C to +70°C	Dice*
MAX734EPA	-40°C to +85°C	8 Plastic DIP
MAX734ESA	-40°C to +85°C	8 SO
MAX734MJA	-55°C to +125°C	8 CERDIP**

\* Contact factory for dice specifications.

\*\* Contact factory for availability and processing to MIL-STD-883.

### Typical Operating Circuit

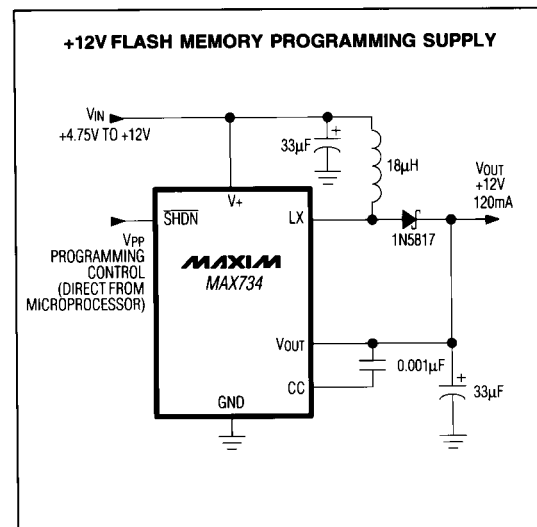

MAXIM

Maxim Integrated Products 1

Call toll free 1-800-998-8800 for free samples or literature

## +12V, 120mA Flash Memory Programming Supply

### ABSOLUTE MAXIMUM RATINGS

Pin Voltages	
V+, LX	+17V, -0.3V
VOUT	±25V
SS, CC, SHDN	-0.3V to (V+ + 0.3V)
Peak Switch Current (ILX)	1.5A
Reference Current (IVREF)	2.5mA
Continuous Power Dissipation (TA = +70°C)	
Plastic DIP (derate 9.09mW/°C above +70°C)	727mW
SO (derate 5.88mW/°C above +70°C)	471mW
CERDIP (derate 8.00mW/°C above +70°C)	640mW

### Operating Temperature Ranges:

MAX734C	0°C to +70°C
MAX734E	-40°C to +85°C
MAX734MJA	-55°C to +125°C
Junction Temperatures:	
MAX734C_J/E	+150°C
MAX734MJA	+175°C
Storage Temperature Range	-65°C to +160°C
Lead Temperature (soldering, 10sec)	+300°C

Stresses beyond those listed under "Absolute Maximum Ratings" may cause permanent damage to the device. These are stress ratings only, and functional operation of the device at these or any other conditions beyond those indicated in the operational sections of the specifications is not implied. Exposure to absolute maximum rating conditions for extended periods may affect device reliability.

### ELECTRICAL CHARACTERISTICS

(Circuit of Figure 1, V+ = 5V, ILOAD = 0mA, TA = TMIN to TMAX, typical values are at TA = +25°C, unless otherwise noted.)

PARAMETER	CONDITIONS	MIN	TYP	MAX	UNITS
Output Voltage	V+ = 4.75V to 12V, Figure 1, 0mA < ILOAD < 120mA	MAX734C/E 11.64	12.12	12.60	V
		MAX734M 11.40	12.12	12.60	
Load Current	V+ = 4.75V, Figure 1		120	150	mA
	V+ = 4.5V, Figure 2		225		
	V+ = 3.0V, Figure 2		150		
Maximum Input Voltage				VOUT	V
Line Regulation	V+ = 5V to 12V		0.20		%/V
Load Regulation	ILOAD = 0mA to 120mA		0.0035		%/mA
Efficiency	V+ = 5V, ILOAD = 120mA		83		%
Supply Current	Includes switch current (Note 1)		1.2	2.5	mA
Standby Current	SHDN = 0, entire circuit		70	100	µA
	SHDN = 0, into V+		6		
Shutdown Input Threshold	VIH	2.0			V
	VIL			0.25	
Shutdown Input Leakage Current				1.0	µA
LX On Resistance	ILX = 500mA		0.5		Ω
LX Leakage Current	VDS = 12V		1.0		µA
Reference Voltage			1.23		V
Reference Drift	TA = TMIN to TMAX		50		ppm°C
Oscillator Frequency			170		kHz
Compensation Pin Impedance			7500		Ω

**Note 1:** Quiescent supply current can be reduced to less than 500µA by pulsing SHDN while supplying 12V to a small load. See *Reducing Operating Supply Current* section.

# +12V, 120mA Flash Memory Programming Supply

## Typical Operating Characteristics

MAX734

(Circuit of Figure 1,  $V_{IN} = +5V$ ,  $V_{OUT} = +12V$ ,  $T_A = +25^\circ C$ , unless otherwise noted.)

**SWITCHING WAVEFORMS - CONTINUOUS CONDUCTION**

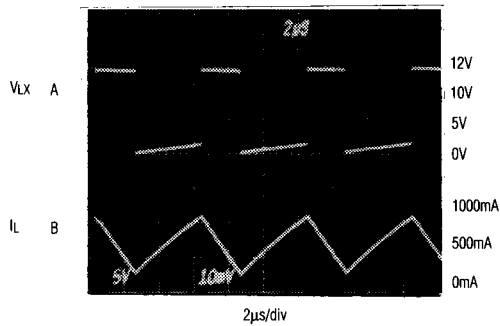

A = LX PIN, 5V/div  
B = INDUCTOR CURRENT, 0.5A/div  
 $I_{OUT} = 150mA$

**SWITCHING WAVEFORMS - DISCONTINUOUS CONDUCTION**

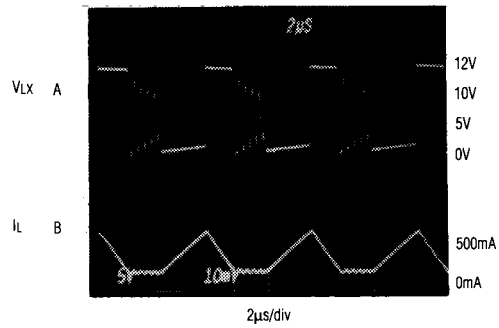

A = LX PIN, 5V/div  
B = INDUCTOR CURRENT, 500mA/div  
 $I_{OUT} = 50mA$

**SHDN RESPONSE TIME**

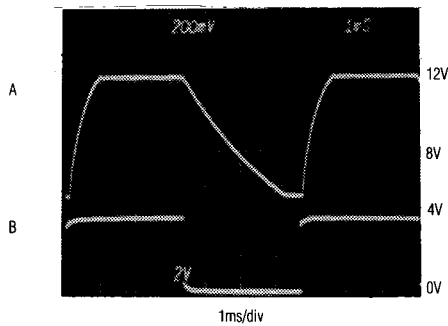

A =  $V_{OUT}$ , LOAD =  $100\Omega$   
B = SHDN, SS = NO CAPACITOR

**LINE-TRANSIENT RESPONSE**

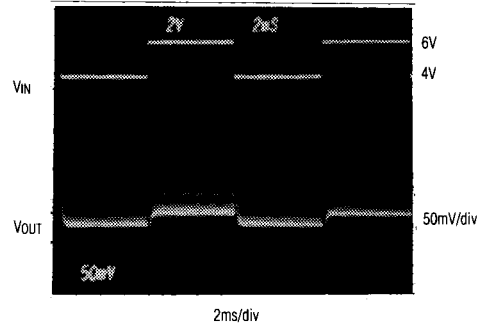

$I_{OUT} = 50mA$

# +12V, 120mA Flash Memory Programming Supply

## Typical Operating Characteristics (continued)

(Circuit of Figure 1,  $V_{IN} = +5V$ ,  $V_{OUT} = +12V$ ,  $T_A = +25^\circ C$ , unless otherwise noted.)

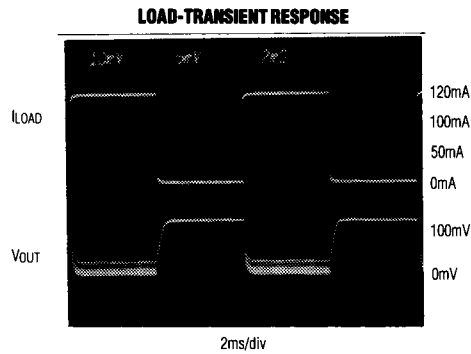
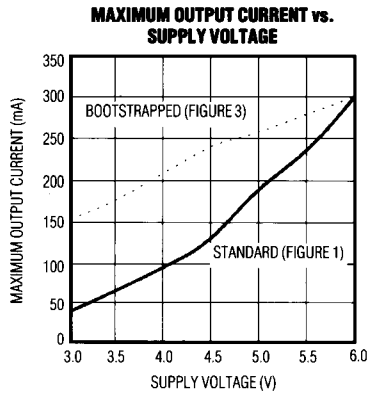
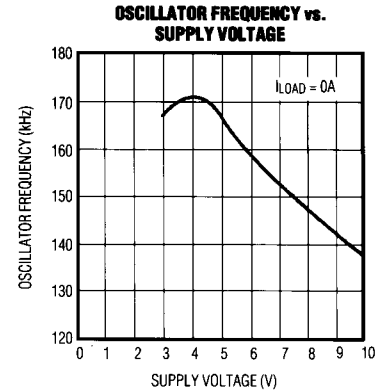
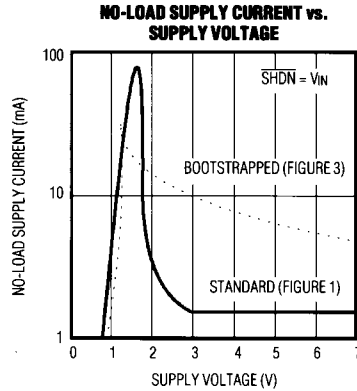
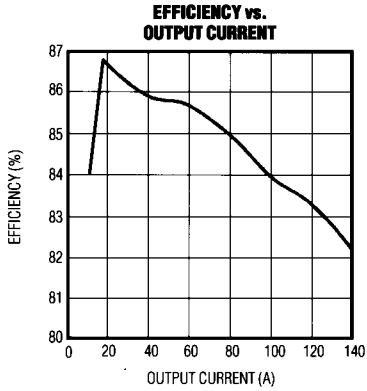

## Pin Description

PIN	NAME	FUNCTION
1	SHDN	Shutdown - active low. Connect to ground to shut down the MAX734. Connect to V+ for normal operation. Power switching FET is held off when SHDN is low.
2	VREF	Reference Voltage Output (+1.23V) - supplies up to 100 $\mu$ A for external loads.
3	SS	Soft-Start. Capacitor between SS and GND provides soft-start and short-circuit protection.
4	CC	Compensation Capacitor Input. Externally compensates the outer feedback loop.
5	GND	Ground
6	LX	Drain of internal N-channel power MOSFET
7	VOUT	Output-Voltage Sense Input. Provides regulation feedback sensing.
8	V+	Supply-Voltage Input. The bypass capacitor must be as close to the device as possible.

# +12V, 120mA Flash Memory Programming Supply

**MAX734**

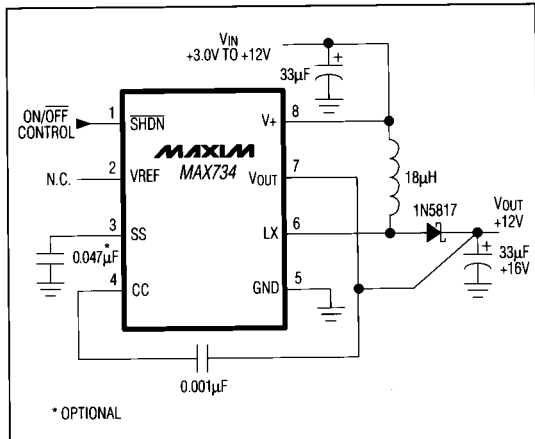

Figure 1. Standard Operating Circuit

Table 1. Typical Soft-Start Times

SUPPLY VOLTAGE (V)	SOFT-START TIME (ms) vs. C <sub>SS</sub> (µF)				
	No C <sub>SS</sub>	0.047µF	0.1µF	0.47µF	1.0µF
5	1	29	55	260	500
7.5		18	27	83	162
9		6	10	47	78

**Note:** Soft-start times are  $\pm 35\%$ . C<sub>1</sub> is the soft-start capacitor (C<sub>SS</sub>); the output capacitor (C<sub>OUT</sub>) = 33µF; I<sub>LOAD</sub> = 75mA.

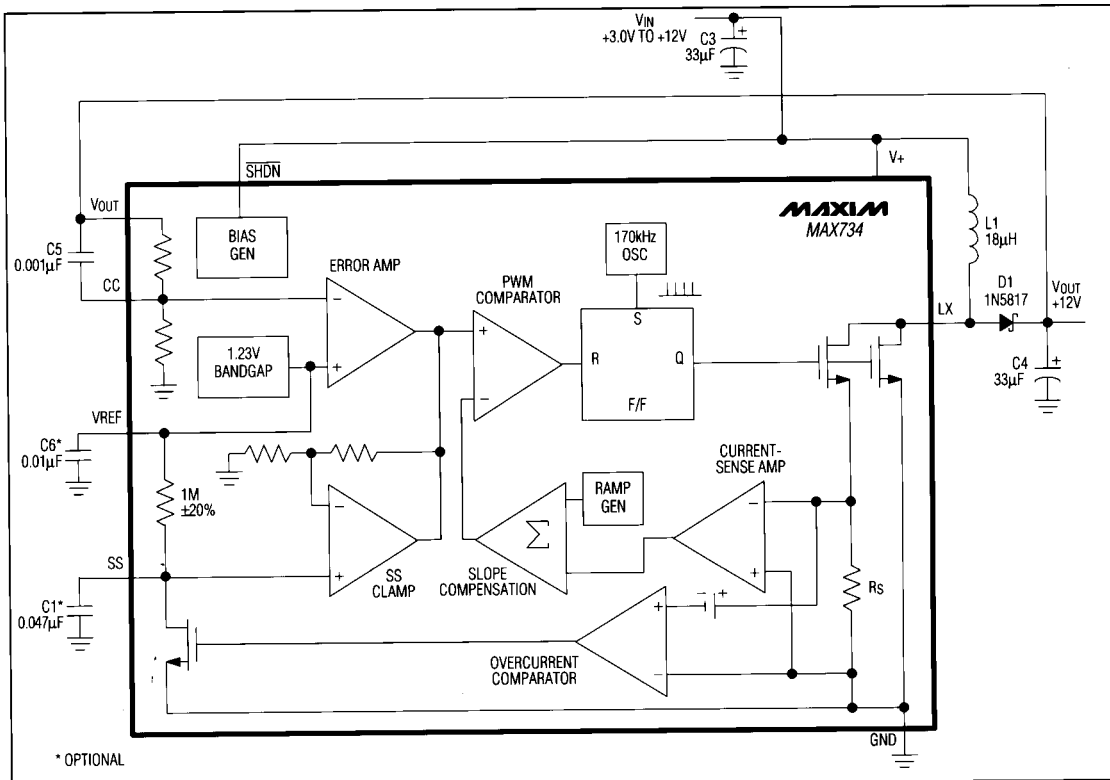

Figure 2. Detailed Block Diagram with External Components

## +12V, 120mA Flash Memory Programming Supply

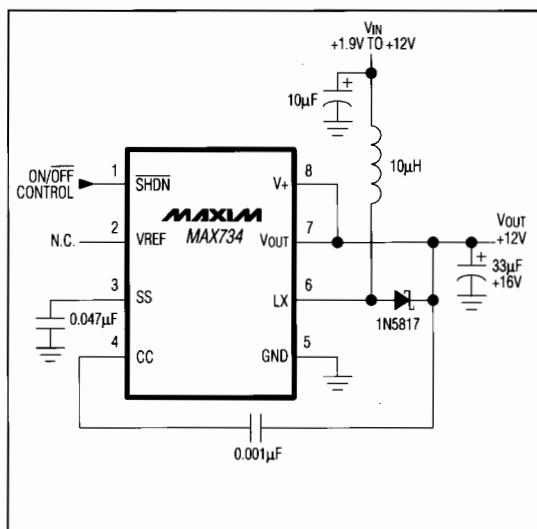

Figure 3. Bootstrap Operation

### Detailed Description

The MAX734 switch-mode regulator uses a current-mode pulse-width modulation (PWM) controller in a simple boost regulator circuit to convert +5V to +12V, as shown in Figure 1. The current-mode PWM architecture provides cycle-by-cycle current limiting and excellent line- and load-transient response characteristics.

#### Operating Principle

The controller consists of two feedback loops: an inner (current) loop that monitors the switch current via the current-sense resistor ( $R_s$ ) and amplifier; and an outer (voltage) loop that monitors the output voltage via the error amplifier (Figure 2). The inner loop performs cycle-by-cycle current limiting, truncating the power transistor on-time when the switch current reaches a predetermined threshold. This threshold is determined by the outer loop. For example, a sagging output voltage produces an error signal that raises the threshold, allowing the circuit to store and transfer more energy during each cycle.

#### Programmable Soft Start

A capacitor connected to the Soft-Start (SS) pin ensures an orderly power-up. The voltage on the charging capacitor slowly raises the clamp on the error-amplifier output voltage, limiting surge currents at power-up by slowly increasing the cycle-by-cycle current-limit threshold.

Soft-start timing is controlled by the value of the SS capacitor. Table 1 lists timing characteristics for selected capacitor values and circuit conditions. Where the circuit is required to start up with no load, for example in flash memory programming supplies, soft start is not required. Omitting  $C_{SS}$  provides a minimum output voltage rise time from the shutdown state, improving access time.

The output voltage falls if more than the maximum load current is drawn. The overcurrent comparator trips if the load exceeds approximately 1.5A. An SS cycle is actively initiated when either an external shutdown signal is switched from ground to above +2V, or an overcurrent fault condition triggers an internal transistor to discharge the SS capacitor to ground.

#### Overcurrent Limiting

When the load current exceeds approximately 1.5A, the output stage is turned off by the inner loop cycle-by-cycle current-limiting action, and the overcurrent comparator signals the control logic to initiate a soft-start cycle. On each clock cycle, the switching MOSFET turns on again and attempts to deliver current until cycle-by-cycle or overcurrent limits are exceeded. Note that the SS capacitor must be at least 0.01µF for overcurrent protection to function properly. The SS period should also be longer than the rise time of the supply voltage to which it is connected.

#### Shutdown

The MAX734 is held in shutdown mode by keeping  $\overline{SHDN}$  at ground. In shutdown, the output power FET is off, but there is still an external path from  $V_+$  to the load via the inductor and diode. The internal reference also turns off, which causes the SS capacitor to discharge. Typical device standby current in shutdown mode is 70µA. When current consumption is critical,  $\overline{SHDN}$  can be pulse modulated with frequencies as high as 1kHz. This provides +12V at less than the maximum output current, but allows dramatic reduction in overall power consumption. For normal operation, connect  $\overline{SHDN}$  to  $V_+$ . An SS cycle is initiated when the MAX734 comes out of shutdown.

Keep  $\overline{SHDN}$  low if  $V_{IN}$  rises slowly between 1V and 2V. This prevents excessive current flow, which could stall weak +5V supplies and/or battery chargers. When  $V_{IN}$  rises more quickly than the SS voltage, this peaking does not occur.

#### Internal Reference

The +1.23V bandgap reference supplies up to 100µA at VREF. A 0.01µF bypass capacitor from VREF to GND is recommended when VREF supplies current.

# +12V, 120mA Flash Memory Programming Supply

**MAX734**

**Table 2. Component Suppliers**

PRODUCTION METHOD	INDUCTORS	CAPACITORS
Surface Mount	Sumida CD54-180 (22μH)  Coiltronics CTX 100-series	Matsuo 267 series
Miniature Through-Hole	Sumida For MAX731: RCH855-180M	Sanyo OS-CON OS-CON series Low ESR Organic Semiconductor
Low-Cost Through-Hole	Renco RL 1284-18	Nichicon PL series Low ESR ElectrolyticS United Chemi-Con LXF series

Coiltronics (USA) .....	(305) 781-8900	Sanyo OS-CON (USA).....	(619) 661-6322
Matsuo (USA) .....	(714) 969-2491	Sanyo OS-CON (Japan).....	(0720) 70-1005
	FAX (714) 960-6492		FAX (0720) 70-1174
Matsuo (Japan) .....	(06) 332-0871	Sumida (USA).....	(708) 956-0666
Nichicon (USA) .....	(708) 843-7500	Sumida (Japan).....	(03) 3607-5111
	FAX (708) 843-2798		FAX (03) 3607-5428
Renco (USA).....	(516) 586-5566	United Chemicon .....	(708) 696-2000
	FAX (516) 586-5562		FAX (708) 640-6311

### **Modes of Operation**

When operating from low input voltages, or when delivering high output currents, the MAX734 operates in continuous-conduction mode. In this mode, current always flows in the inductor and the control circuit adjusts the duty-cycle of the switch on a cycle-by-cycle basis to maintain regulation without exceeding the switch-current capability. This provides excellent load-transient response. When operating from high input voltages, or when delivering light loads, this method cannot adjust the duty cycle to the correct value, so the controller changes to discontinuous mode.

In discontinuous mode, current through the inductor starts at zero, rises to a peak value, then ramps down to zero on each cycle. Although efficiency is still excellent, the output ripple increases slightly and the switch waveforms contain ringing (the self-resonant frequency of the inductor). This ringing is to be expected, and poses no operational problems.

At load currents under a few milliamperes, even the discontinuous mode tends to put more energy into the coil than the load requires, so the controller changes to a

pulse-skipping mode in which regulation is achieved by skipping entire cycles. Efficiency is still good, typically 70% to 80%, reduced mainly because the MAX734 quiescent supply current becomes a significantly larger fraction of the total current when load currents are low. Pulse-skipping switch waveforms are irregular and the output ripple contains a low-frequency component that may exceed 50mV. Larger, low-ESR filter capacitors connected to VOUT can help reduce the ripple voltage in critical applications.

Continuous-current mode operation gives a cleaner output than discontinuous or pulse-skipping operation: peak-to-peak ripple amplitude is minimized and the ripple frequency is fixed at the oscillator frequency. Both conditions make the output easy to filter.

### **Applications Information**

#### **Flash Memory Supply**

Figure 1 shows the standard step-up application circuit. This circuit is used to generate +12V from a nominal +5V source, and is well suited for powering flash memory programming, since the SHDN pin can be controlled by the system logic.

## +12V, 120mA Flash Memory Programming Supply

### Inductor Selection

An 18 $\mu$ H inductor is sufficient for most designs. The important specification is the inductor's incremental saturation current rating, which should be greater than three times the DC load current for 5V inputs and five times the DC load for 3V inputs. For lower-power applications, smaller inductor values may be used. Table 2 lists recommended inductor types and suppliers for various applications. The listed surface-mount inductors' efficiencies are nearly equivalent to those of the larger-sized, through-hole inductors.

### Output Filter Capacitor Selection

The primary criterion for selecting the output filter capacitor is low effective series resistance (ESR). The product of the inductor current variation and the ESR of the output capacitor determines the amplitude of the high frequency seen on the output voltage. The capacitor's ESR should be less than 0.25 $\Omega$  to keep the output ripple less than 50mV<sub>p-p</sub> over the entire current range (using an 18 $\mu$ H inductor). In addition, the output filter capacitor's ESR should be minimized to maintain AC stability. Table 2 lists some suppliers of low-ESR capacitors.

### Other Components

Use a Schottky diode or high-speed silicon rectifier with a continuous current rating of at least 300mA for full-load (120mA) operation. The 1N5817 is a good choice. The compensation capacitor (CC) value at the CC input is critical because it has been selected to provide the best transient response.

### Printed Circuit Layout

Printed circuit board layout is not critical except to ensure quiet operation. A ground plane is recommended. Locate bypass capacitors as close to the device as possible to prevent instability and noise pickup. If the V+ to GND bypass capacitor cannot be placed adjacent to the IC pins, bypass these pins directly with a small ceramic capacitor (e.g. 0.1 $\mu$ F). Keep the Schottky diode leads short to prevent fast rise-time pulses in the output. Minimize stray capacitance at the LX pin.

Do not use plug-in plastic proto-boards.

### Reducing Operating Supply Current

In normal operation with no load, the MAX734 draws about 1.2mA. At full load, this supply current contributes only slightly to inefficiency, but when operating at very light loads, e.g. a few milliamps, it begins to dominate the efficiency calculations. In these circumstances, the SHDN pin can be toggled with a logic signal to reduce the chip's supply current to about 500 $\mu$ A. The toggle signal required depends on the load demanded, but a typical application would use a 25% duty cycle at 1kHz.

### Bootstrapped Output Circuit

If additional output current is required, the bootstrapped circuit (Figure 3) can be used. This circuit operates on the +12V that it creates (bootstrapped) and produces more output current than the non-bootstrapped circuit with input voltages under +6V. The no-load quiescent current (SHDN = HI) is greater than the normal circuit, but it is unchanged in shutdown mode. See the *Typical Operating Characteristics*.

### Chip Topography

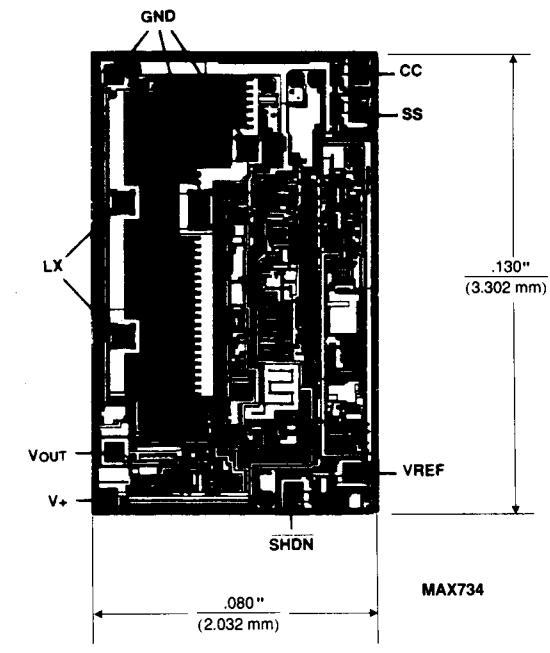

NOTE: SUBSTRATE CONNECTED TO V+;  
TRANSISTOR COUNT: 222.