

# LMH6640

## TFT-LCD Single, 16V Rail-to-Rail High Output Operational Amplifier

### General Description

The LMH<sup>™</sup>6640 is a voltage feedback operational amplifier with a rail-to-rail output drive capability of 100 mA. Employing National's patented VIP10 process, the LMH6640 delivers a bandwidth of 190 MHz at a current consumption of only 4mA. An input common mode voltage range extending to 0.3V below the V<sub>-</sub> and to within 0.9V of V<sub>+</sub>, makes the LMH6640 a true single supply op-amp. The output voltage range extends to within 100 mV of either supply rail providing the user with a dynamic range that is especially desirable in low voltage applications.

The LMH6640 offers a slew rate of 170 V/μs resulting in a full power bandwidth of approximately 28 MHz with 5V single supply (2 V<sub>PP</sub>, -1 dB). Careful attention has been paid to ensure device stability under all operating voltages and modes. The result is a very well behaved frequency response characteristic for any gain setting including +1, and excellent specifications for driving video cables including total harmonic distortion of -64 dBc @ 5 MHz, differential gain of 0.12% and differential phase of 0.12°.

### Features

(V<sub>S</sub> = 16V, R<sub>L</sub> = 2 kΩ to V<sup>+</sup>/2, 25°C, Typical Values Unless Specified)

■ Supply current (no load)	4 mA
■ Output resistance (closed loop 1 MHz)	0.35Ω
■ -3 dB BW (A <sub>V</sub> = 1)	190 MHz
■ Settling time (±0.1%, 2 V <sub>PP</sub> )	35 ns
■ Input common mode voltage	-0.3V to 15.1V
■ Output voltage swing	100 mV from rails
■ Linear output current	±100 mA
■ Total harmonic distortion (2 V <sub>PP</sub> , 5 MHz)	-64 dBc
■ Fully characterized for:	5V & 16V
■ No output phase reversal with CMVR exceeded	
■ Differential gain (R <sub>L</sub> = 150Ω)	0.12%
■ Differential phase (R <sub>L</sub> = 150Ω)	0.12°

### Applications

- TFT panel V<sub>COM</sub> buffer amplifier
- Active filters
- CD/DVD ROM
- ADC buffer amplifier
- Portable video
- Current sense buffer

### Typical Application

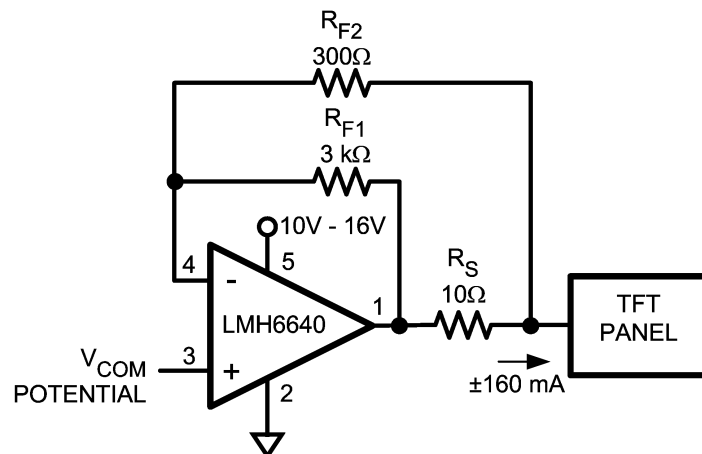

Typical Application as a TFT Panel V<sub>COM</sub> Driver

20086234

LMH<sup>™</sup> is a trademark of National Semiconductor Corporation.

**Absolute Maximum Ratings** (Note 1)

If Military/Aerospace specified devices are required, please contact the National Semiconductor Sales Office/Distributors for availability and specifications.

ESD Tolerance (Note 2)	
Human Body Model	2 KV
Machine Model	200V
V <sub>IN</sub> Differential	±2.5V
Input Current	±10 mA
Supply Voltages (V <sup>+</sup> – V <sup>-</sup> )	18V
Voltage at Input/Output Pins	V <sup>+</sup> +0.8V, V <sup>-</sup> –0.8V
Storage Temperature Range	–65°C to +150°C

Junction Temperature (Note 4)	+150°C
Soldering Information	
Infrared or Convection (20 sec.)	235°C
Wave Soldering (10 sec.)	260°C

**Operating Ratings** (Note 3)

Supply Voltage (V <sup>+</sup> – V <sup>-</sup> )	4.5V to 16V
Operating Temperature Range (Note 4)	–40°C to +85°C
Package Thermal Resistance (Note 4)	
5-Pin SOT23	265°C/W

**5V Electrical Characteristics**

Unless otherwise specified, All limits guaranteed for T<sub>J</sub> = 25°C, V<sup>+</sup> = 5V, V<sup>-</sup> = 0V, V<sub>O</sub> = V<sub>CM</sub> = V<sup>+</sup>/2 and R<sub>L</sub> = 2 kΩ to V<sup>+</sup>/2. **Boldface** limits apply at temperature extremes. (Note 9)

Symbol	Parameter	Conditions	Min (Note 6)	Typ (Note 5)	Max (Note 6)	Units
BW	–3 dB Bandwidth	A <sub>V</sub> = +1 (R <sub>L</sub> = 100Ω)		150		MHz
		A <sub>V</sub> = –1 (R <sub>L</sub> = 100Ω)		58		
BW <sub>0.1 dB</sub>	0.1 dB Gain Flatness	A <sub>V</sub> = –3		18		MHz
FPBW	Full Power Bandwidth	A <sub>V</sub> = +1, V <sub>OUT</sub> = 2 V <sub>PP</sub> , –1 dB		28		MHz
LSBW	–3 dB Bandwidth	A <sub>V</sub> = +1, V <sub>O</sub> = 2 V <sub>PP</sub> (R <sub>L</sub> = 100Ω)		32		MHz
GBW	Gain Bandwidth Product	A <sub>V</sub> = +1, (R <sub>L</sub> = 100Ω)		59		MHz
SR	Slew Rate (Note 8)	A <sub>V</sub> = –1		170		V/μs
e <sub>n</sub>	Input Referred Voltage Noise	f = 10 kHz		23		nV/ √Hz
		f = 1 MHz		15		
i <sub>n</sub>	Input Referred Current Noise	f = 10 kHz		1.1		pA/ √Hz
		f = 1 MHz		0.7		
THD	Total Harmonic Distortion	f = 5 MHz, V <sub>O</sub> = 2 V <sub>PP</sub> , A <sub>V</sub> = +2 R <sub>L</sub> = 1 kΩ to V <sup>+</sup> /2		–65		dBc
t <sub>s</sub>	Settling Time	V <sub>O</sub> = 2 V <sub>PP</sub> , ±0.1%, A <sub>V</sub> = –1		35		ns
V <sub>OS</sub>	Input Offset Voltage			1	5 7	mV
I <sub>B</sub>	Input Bias Current (Note 7)			–1.2	–2.6 –3.25	μA
I <sub>OS</sub>	Input Offset Current			34	800 1400	nA
CMVR	Common Mode Input Voltage Range	CMRR ≥ 50 dB		–0.3	–0.2 –0.1	V
			4.0 3.6	4.1		
CMRR	Common Mode Rejection Ratio	V <sup>-</sup> ≤ V <sub>CM</sub> ≤ V <sup>+</sup> –1.5V	72	90		dB
A <sub>VOL</sub>	Large Signal Voltage Gain	V <sub>O</sub> = 4 V <sub>PP</sub> , R <sub>L</sub> = 2 kΩ to V <sup>+</sup> /2	86 82	95		dB
		V <sub>O</sub> = 3.75 V <sub>PP</sub> , R <sub>L</sub> = 150Ω to V <sup>+</sup> /2	74 70	78		
V <sub>O</sub>	Output Swing High	R <sub>L</sub> = 2 kΩ to V <sup>+</sup> /2	4.90	4.94		V
		R <sub>L</sub> = 150Ω to V <sup>+</sup> /2	4.75	4.80		
	Output Swing Low	R <sub>L</sub> = 2 kΩ to V <sup>+</sup> /2		0.06	0.10	
		R <sub>L</sub> = 150Ω to V <sup>+</sup> /2		0.20	0.25	

## 5V Electrical Characteristics (Continued)

Unless otherwise specified, All limits guaranteed for  $T_J = 25^\circ\text{C}$ ,  $V^+ = 5\text{V}$ ,  $V^- = 0\text{V}$ ,  $V_O = V_{CM} = V^+/2$  and  $R_L = 2\text{ k}\Omega$  to  $V^+/2$ .  
**Boldface** limits apply at temperature extremes. (Note 9)

Symbol	Parameter	Conditions	Min (Note 6)	Typ (Note 5)	Max (Note 6)	Units
$I_{SC}$	Output Short Circuit Current (Note 3)	Sourcing to $V^+/2$	100 <b>75</b>	130		mA
		Sinking from $V^+/2$	100 <b>70</b>	130		
$I_{OUT}$	Output Current	$V_O = 0.5\text{V}$ from either Supply		+75/-90		mA
PSRR	Power Supply Rejection Ratio	$4\text{V} \leq V^+ \leq 6\text{V}$	72	80		dB
$I_S$	Supply Current	No Load		3.7	5.5 <b>8.0</b>	mA
$R_{IN}$	Common Mode Input Resistance	$A_V = +1$ , $f = 1\text{ kHz}$ , $R_S = 1\text{ M}\Omega$		15		$\text{M}\Omega$
$C_{IN}$	Common Mode Input Capacitance	$A_V = +1$ , $R_S = 100\text{ k}\Omega$		1.7		pF
$R_{OUT}$	Output Resistance Closed Loop	$R_F = 10\text{ k}\Omega$ , $f = 1\text{ kHz}$ , $A_V = -1$		0.1		$\Omega$
		$R_F = 10\text{ k}\Omega$ , $f = 1\text{ MHz}$ , $A_V = -1$		0.4		
DG	Differential Gain	NTSC, $A_V = +2$ $R_L = 150\Omega$ to $V^+/2$		0.13		%
DP	Differential Phase	NTSC, $A_V = +2$ $R_L = 150\Omega$ to $V^+/2$		0.10		deg

## 16V Electrical Characteristics

Unless otherwise specified, All limits guaranteed for  $T_J = 25^\circ\text{C}$ ,  $V^+ = 16\text{V}$ ,  $V^- = 0\text{V}$ ,  $V_O = V_{CM} = V^+/2$  and  $R_L = 2\text{ k}\Omega$  to  $V^+/2$ .  
**Boldface** limits apply at temperature extremes. (Note 9)

Symbol	Parameter	Conditions	Min (Note 6)	Typ (Note 5)	Max (Note 6)	Units
BW	-3 dB Bandwidth	$A_V = +1$ ( $R_L = 100\Omega$ )		190		MHz
		$A_V = -1$ ( $R_L = 100\Omega$ )		60		
$BW_{0.1\text{ dB}}$	0.1 dB Gain Flatness	$A_V = -2.7$		20		MHz
LSBW	-3 dB Bandwidth	$A_V = +1$ , $V_O = 2 V_{PP}$ ( $R_L = 100\Omega$ )		35		MHz
GBW	Gain Bandwidth Product	$A_V = +1$ , ( $R_L = 100\Omega$ )		62		MHz
SR	Slew Rate (Note 8)	$A_V = -1$		170		V/ $\mu\text{s}$
$e_n$	Input Referred Voltage Noise	$f = 10\text{ kHz}$		23		nV/ $\sqrt{\text{Hz}}$
		$f = 1\text{ MHz}$		15		
$i_n$	Input Referred Current Noise	$f = 10\text{ kHz}$		1.1		pA/ $\sqrt{\text{Hz}}$
		$f = 1\text{ MHz}$		0.7		
THD	Total Harmonic Distortion	$f = 5\text{ MHz}$ , $V_O = 2 V_{PP}$ , $A_V = +2$ $R_L = 1\text{ k}\Omega$ to $V^+/2$		-64		dBc
$t_s$	Settling Time	$V_O = 2 V_{PP}$ , $\pm 0.1\%$ , $A_V = -1$		35		ns
$V_{OS}$	Input Offset Voltage			1	5 <b>7</b>	mV
$I_B$	Input Bias Current (Note 7)			-1	-2.6 <b>-3.5</b>	$\mu\text{A}$
$I_{OS}$	Input Offset Current			34	800 <b>1800</b>	nA
CMVR	Common Mode Input Voltage Range	CMRR $\geq 50\text{ dB}$		-0.3	-0.2 <b>-0.1</b>	V
			15.0 <b>14.6</b>	15.1		
CMRR	Common Mode Rejection Ratio	$V^- \leq V_{CM} \leq V^+ - 1.5\text{V}$	72	90		dB

## 16V Electrical Characteristics (Continued)

Unless otherwise specified, All limits guaranteed for  $T_J = 25^\circ\text{C}$ ,  $V^+ = 16\text{V}$ ,  $V^- = 0\text{V}$ ,  $V_O = V_{CM} = V^+/2$  and  $R_L = 2\text{ k}\Omega$  to  $V^+/2$ . **Boldface** limits apply at temperature extremes. (Note 9)

Symbol	Parameter	Conditions	Min (Note 6)	Typ (Note 5)	Max (Note 6)	Units
$A_{VOL}$	Large Signal Voltage Gain	$V_O = 15 V_{PP}$ , $R_L = 2\text{ k}\Omega$ to $V^+/2$	86 <b>82</b>	95		dB
		$V_O = 14 V_{PP}$ , $R_L = 150\Omega$ to $V^+/2$	74 <b>70</b>	78		
$V_O$	Output Swing High	$R_L = 2\text{ k}\Omega$ to $V^+/2$	15.85	15.90		V
		$R_L = 150\Omega$ to $V^+/2$	15.45	15.78		
	Output Swing Low	$R_L = 2\text{ k}\Omega$ to $V^+/2$		0.10	0.15	
		$R_L = 150\Omega$ to $V^+/2$		0.21	0.55	
$I_{SC}$	Output Short Circuit Current (Note 3)	Sourcing to $V^+/2$	60 <b>30</b>	95		mA
		Sinking from $V^+/2$	50 <b>15</b>	75		
$I_{OUT}$	Output Current	$V_O = 0.5\text{V}$ from either Supply		$\pm 100$		mA
PSRR	Power Supply Rejection Ratio	$15\text{V} \leq V^+ \leq 17\text{V}$	72	80		dB
$I_S$	Supply Current	No Load		4	6.5 <b>7.8</b>	mA
$R_{IN}$	Common Mode Input Resistance	$A_V = +1$ , $f = 1\text{ kHz}$ , $R_S = 1\text{ M}\Omega$		32		$\text{M}\Omega$
$C_{IN}$	Common Mode Input Capacitance	$A_V = +1$ , $R_S = 100\text{ k}\Omega$		1.7		pF
$R_{OUT}$	Output Resistance Closed Loop	$R_F = 10\text{ k}\Omega$ , $f = 1\text{ kHz}$ , $A_V = -1$		0.1		$\Omega$
		$R_F = 10\text{ k}\Omega$ , $f = 1\text{ MHz}$ , $A_V = -1$		0.3		
DG	Differential Gain	NTSC, $A_V = +2$ $R_L = 150\Omega$ to $V^+/2$		0.12		%
DP	Differential Phase	NTSC, $A_V = +2$ $R_L = 150\Omega$ to $V^+/2$		0.12		deg

**Note 1:** Absolute maximum Ratings indicate limits beyond which damage to the device may occur. Operating Ratings indicate conditions for which the device is intended to be functional, but specific performance is not guaranteed. For guaranteed specifications and the test conditions, see the Electrical Characteristics.

**Note 2:** Human body model,  $1.5\text{ k}\Omega$  in series with  $100\text{ pF}$ . Machine Model,  $0\Omega$  in series with  $200\text{ pF}$ .

**Note 3:** Applies to both single-supply and split-supply operation. Continuous short circuit operation at elevated ambient temperature can result in exceeding the maximum allowed junction temperature of  $150^\circ\text{C}$ . Short circuit test is a momentary test. Output short circuit duration is infinite for  $V_S < 6\text{V}$  at room temperature and below. For  $V_S > 6\text{V}$ , allowable short circuit duration is  $1.5\text{ ms}$ .

**Note 4:** The maximum power dissipation is a function of  $T_{J(MAX)}$ ,  $\theta_{JA}$ , and  $T_A$ . The maximum allowable power dissipation at any ambient temperature is  $P_D = (T_{J(MAX)} - T_A) / \theta_{JA}$ . All numbers apply for packages soldered directly onto a PC board.

**Note 5:** Typical Values represent the most likely parametric norm.

**Note 6:** All limits are guaranteed by testing or statistical analysis.

**Note 7:** Positive current corresponds to current flowing into the device.

**Note 8:** Slew rate is the average of the rising and falling slew rates

**Note 9:** Electrical Table values apply only for factory testing conditions at the temperature indicated. Factory testing conditions result in very limited self-heating of the device such that  $T_J = T_A$ . No guarantee of parametric performance is indicated in the electrical tables under conditions of internal self-heating where  $T_J > T_A$ .

## Connection Diagram

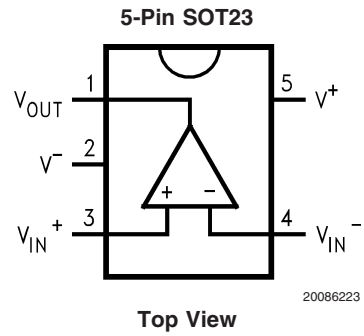

## Ordering Information

Package	Part Number	Package Marking	Transport Media	NSC Drawing
5-Pin SOT23	LMH6640MF	AH1A	1k Units Tape and Reel	MF05A
	LMH6640MFX		3k Units Tape and Reel	

**Typical Performance Characteristics** At  $T_J = 25^\circ\text{C}$ ,  $V^+ = 16\text{ V}$ ,  $V^- = 0\text{ V}$ ,  $R_F = 330\Omega$  for  $A_V = +2$ ,  $R_F = 1\text{ k}\Omega$  for  $A_V = -1$ .  $R_L$  tied to  $V^+/2$ . Unless otherwise specified.

**$I_S$  vs.  $V_S$  for Various Temperature**

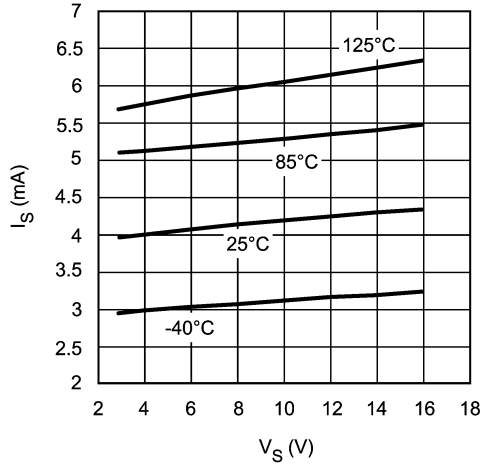

20086221

**$I_S$  vs.  $V_{CM}$  for Various Temperature**

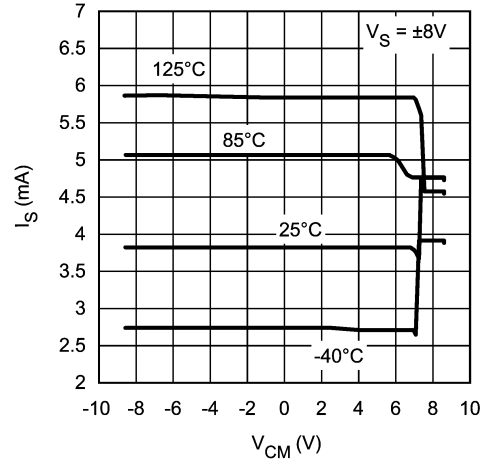

20086220

**$I_B$  vs.  $V_S$  for Various Temperature**

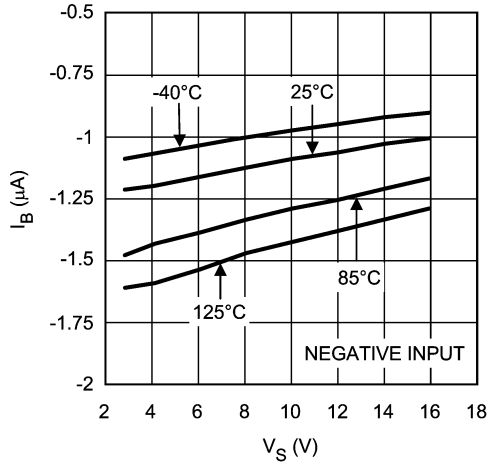

20086218

**$I_B$  vs.  $V_S$  for Various Temperature**

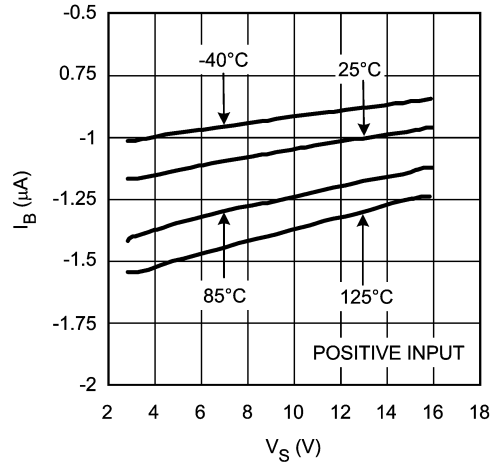

20086219

**$V_{OS}$  vs.  $V_S$  for Various Temperature (Typical Unit)**

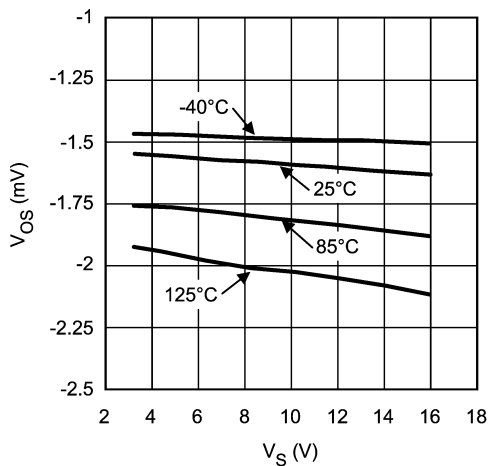

20086216

**$I_{OS}$  vs.  $V_S$  for Various Temperature**

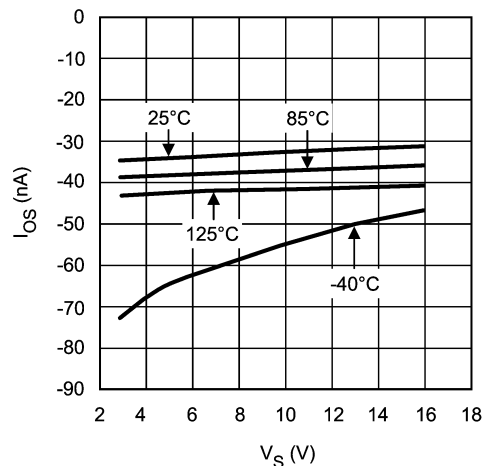

20086227

**Typical Performance Characteristics** At  $T_J = 25^\circ\text{C}$ ,  $V^+ = 16\text{V}$ ,  $V^- = 0\text{V}$ ,  $R_F = 330\Omega$  for  $A_V = +2$ ,  $R_F = 1\text{k}\Omega$  for  $A_V = -1$ .  $R_L$  tied to  $V^+/2$ . Unless otherwise specified. (Continued)

**Positive Output Saturation Voltage vs.  $V_S$  for Various Temperature**

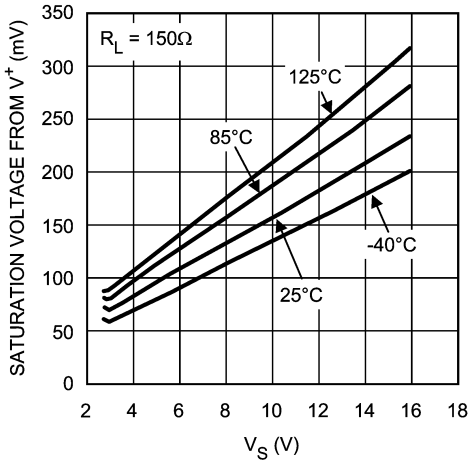

20086224

**Negative Output Saturation Voltage vs.  $V_S$  for Various Temperature**

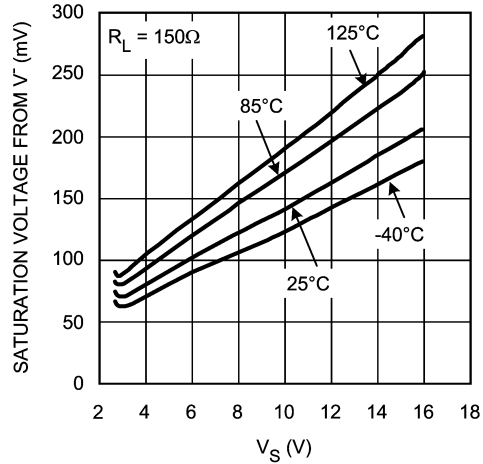

20086228

**Output Sinking Saturation Voltage vs.  $I_{\text{SINKING}}$  for Various Temperature**

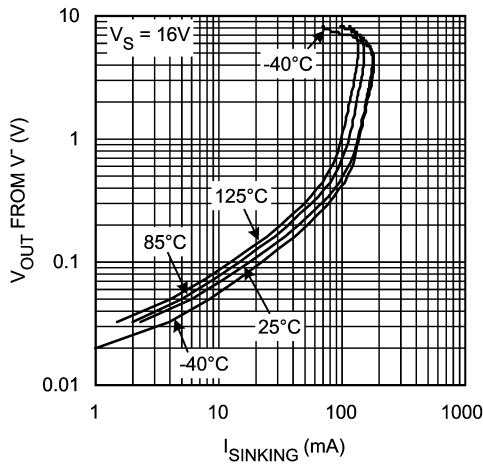

20086230

**Output Sourcing Saturation Voltage vs.  $I_{\text{SOURCING}}$  for Various Temperature**

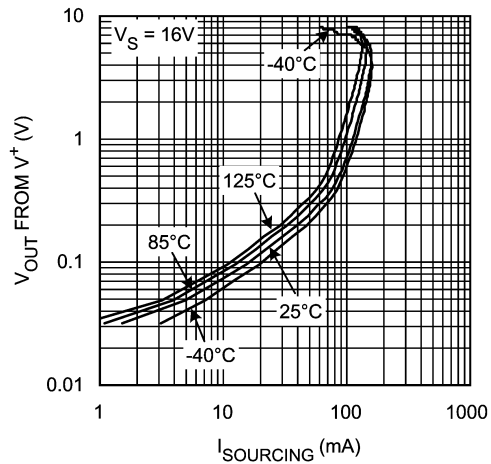

20086231

**Input Current Noise vs. Frequency**

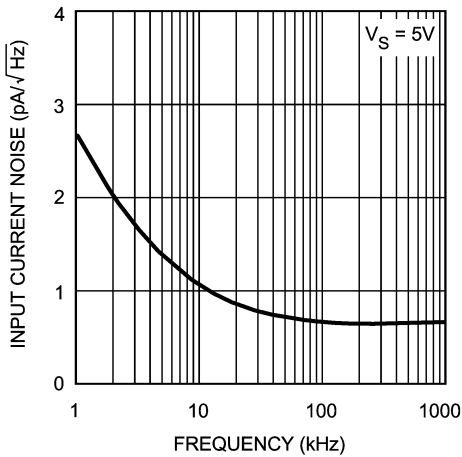

20086204

**Input Voltage Noise vs. Frequency**

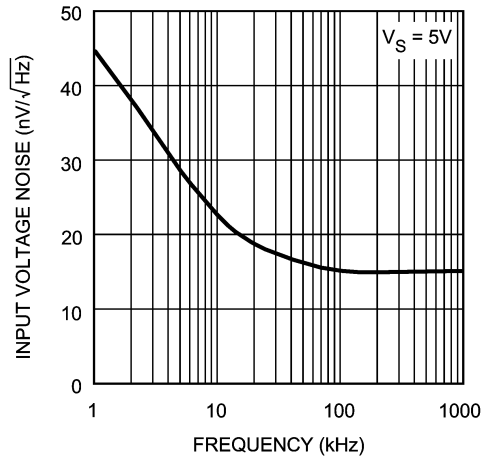

20086205

**Typical Performance Characteristics** At  $T_J = 25^\circ\text{C}$ ,  $V^+ = 16\text{V}$ ,  $V^- = 0\text{V}$ ,  $R_F = 330\Omega$  for  $A_V = +2$ ,  $R_F = 1\text{k}\Omega$  for  $A_V = -1$ .  $R_L$  tied to  $V^+/2$ . Unless otherwise specified. (Continued)

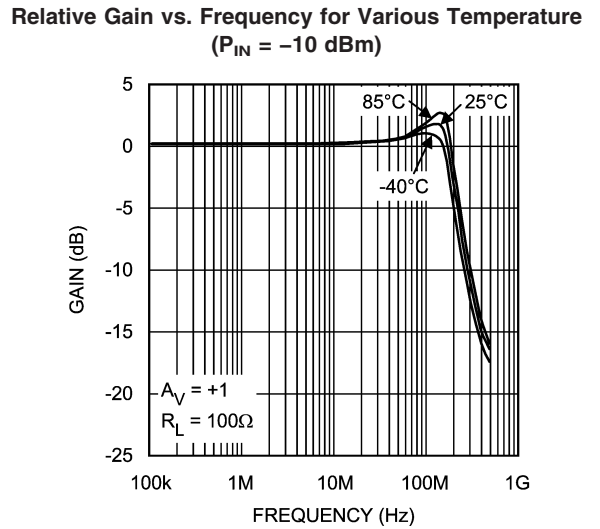
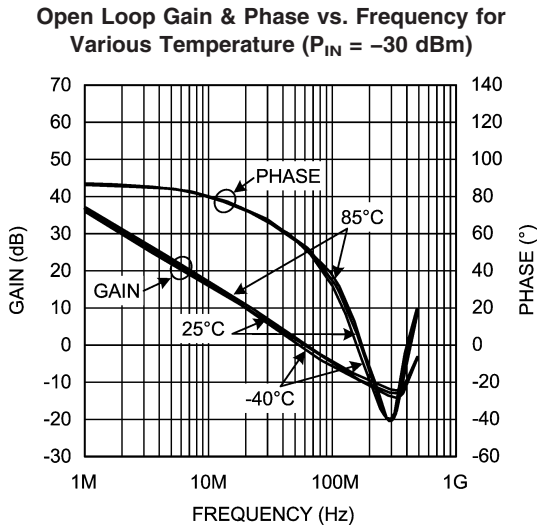
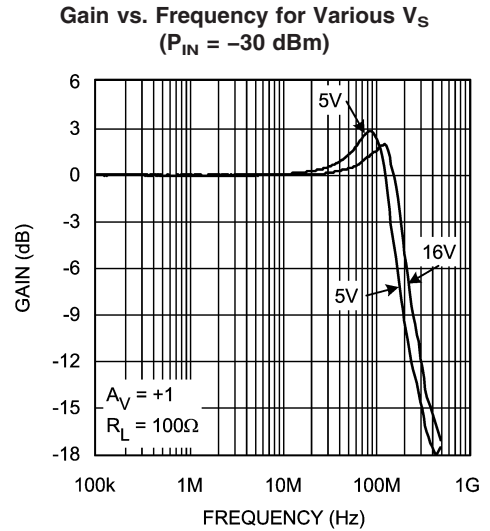
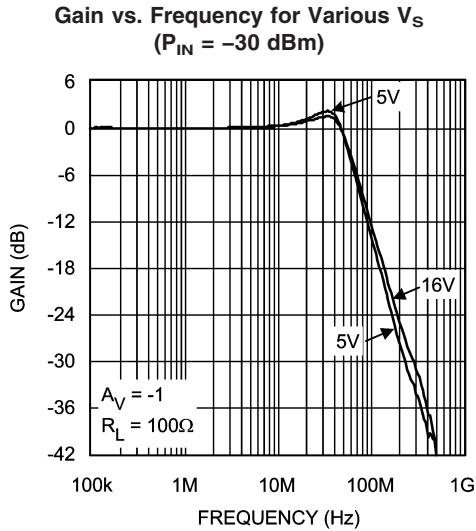
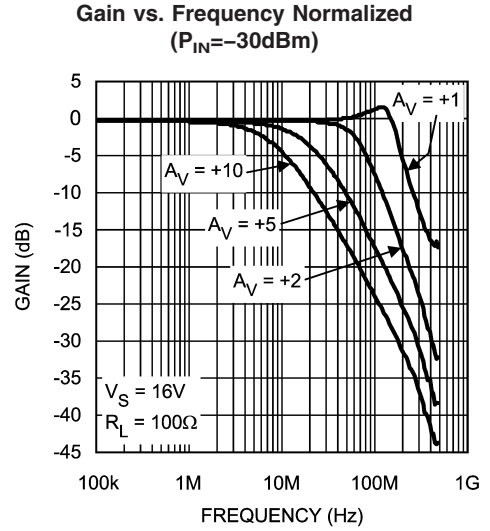
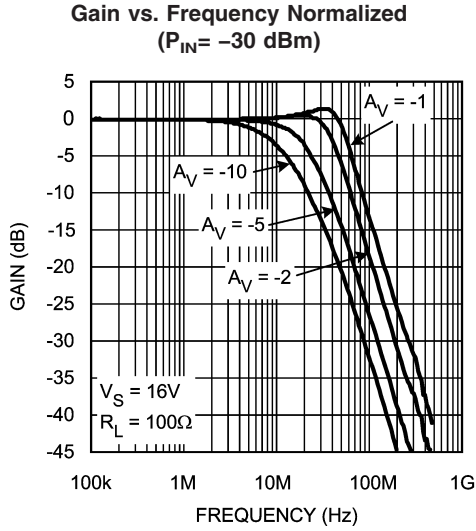



**Typical Performance Characteristics** At  $T_J = 25^\circ\text{C}$ ,  $V^+ = 16\text{ V}$ ,  $V^- = 0\text{ V}$ ,  $R_F = 330\Omega$  for  $A_V = +2$ ,  $R_F = 1\text{ k}\Omega$  for  $A_V = -1$ .  $R_L$  tied to  $V^+/2$ . Unless otherwise specified. (Continued)

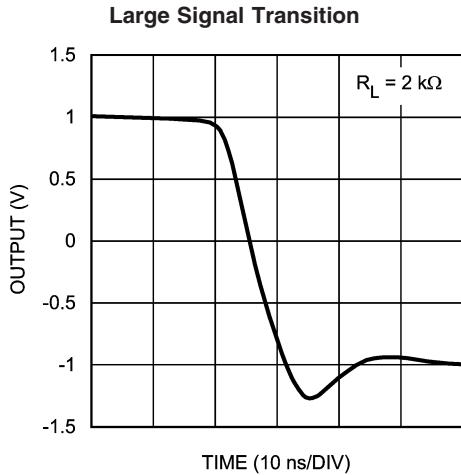

20086213

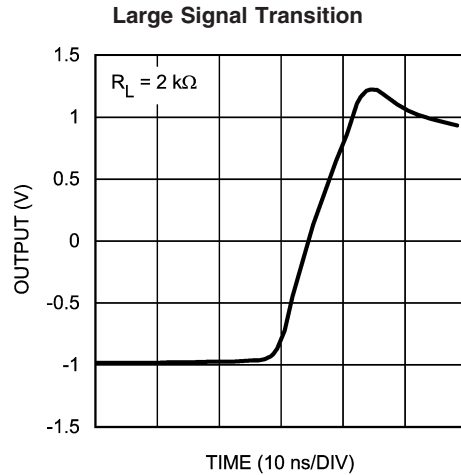

20086214

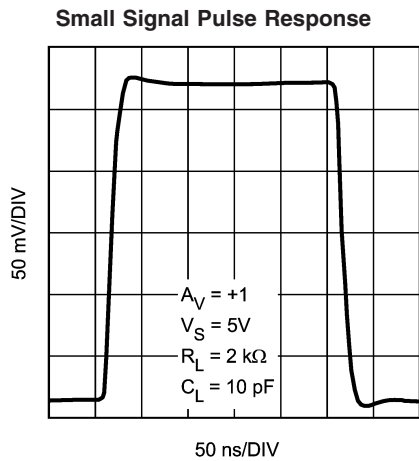

20086208

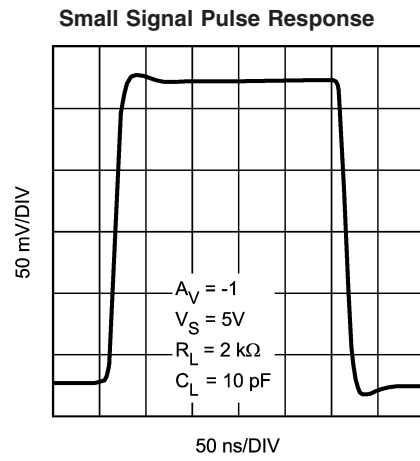

20086215

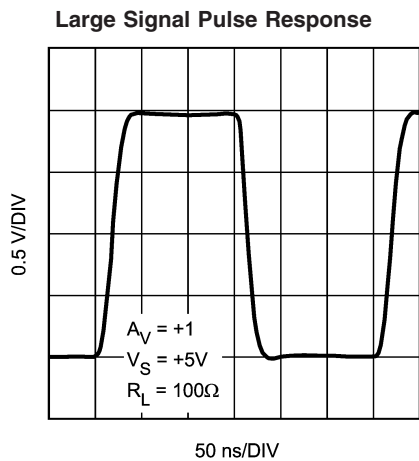

20086211

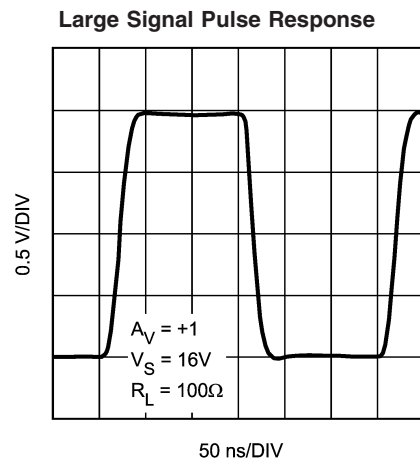

20086212

**Typical Performance Characteristics** At  $T_J = 25^\circ\text{C}$ ,  $V^+ = 16\text{ V}$ ,  $V^- = 0\text{ V}$ ,  $R_F = 330\Omega$  for  $A_V = +2$ ,  $R_F = 1\text{ k}\Omega$  for  $A_V = -1$ .  $R_L$  tied to  $V^+/2$ . Unless otherwise specified. (Continued)

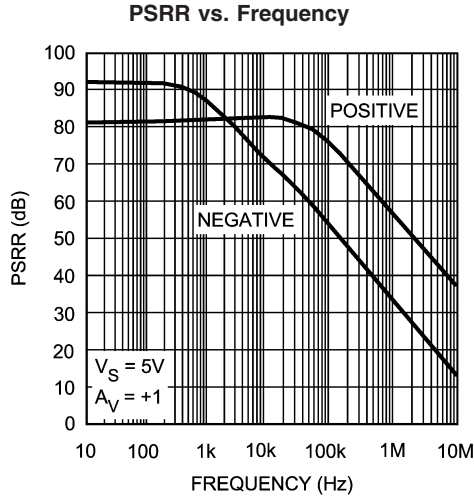

20086201

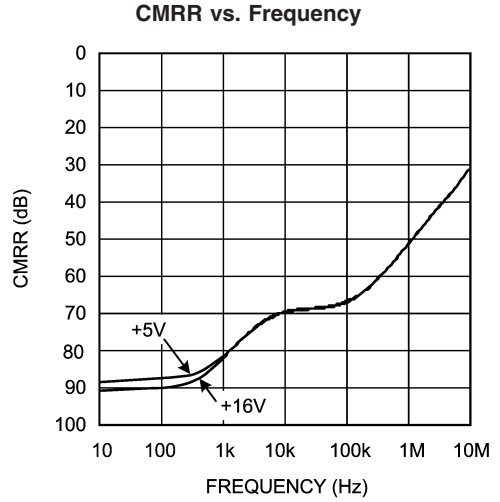

20086217

**Closed Loop Output Resistance vs. Frequency**

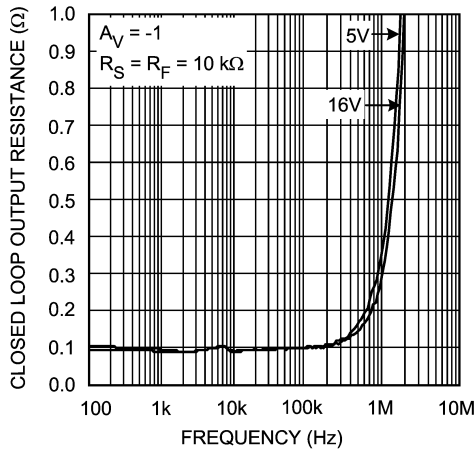

20086203

**Harmonic Distortion**

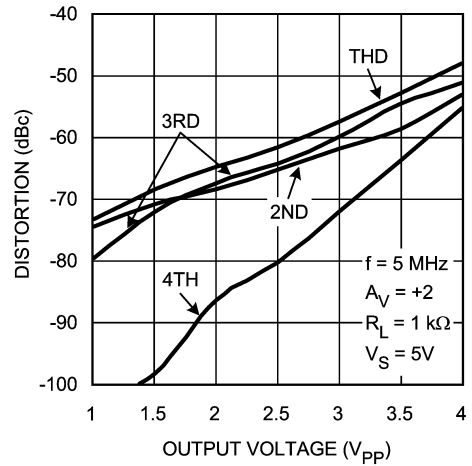

20086226

**0.1 dB Gain Flatness vs. Frequency Normalized**

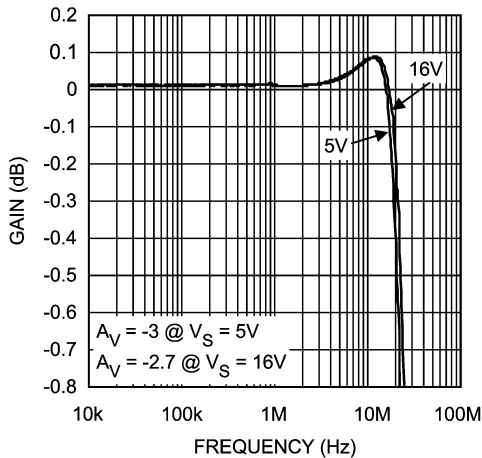

20086202

**Output Power vs. Input Power ( $A_V = +1$ )**

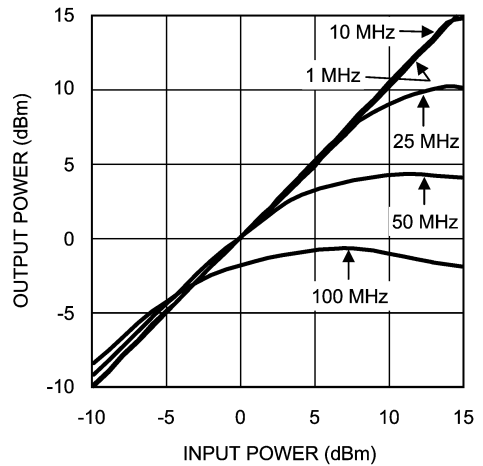

20086229

## Typical Performance Characteristics

At  $T_J = 25^\circ\text{C}$ ,  $V^+ = 16\text{ V}$ ,  $V^- = 0\text{V}$ ,  $R_F = 330\Omega$  for  $A_V = +2$ ,  $R_F = 1\text{ k}\Omega$  for  $A_V = -1$ .  $R_L$  tied to  $V^+/2$ . Unless otherwise specified. (Continued)

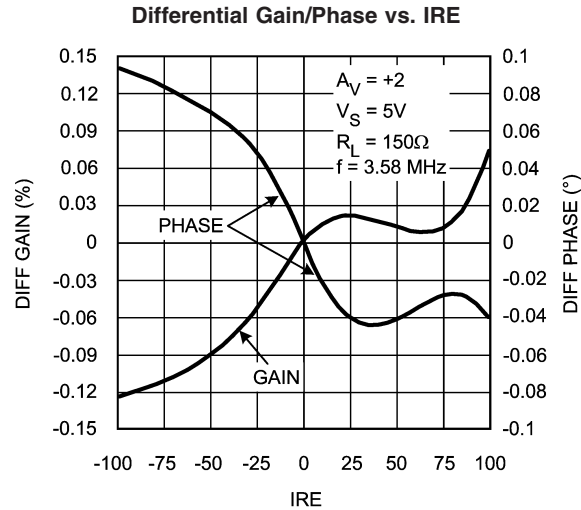

## Application Notes

With its high output current and speed, one of the major applications for the LMH6640 is the  $V_{\text{COM}}$  driver in a TFT panel. This application is a specially taxing one because of the demands it places on the operational amplifier's output to drive a large amount of bi-directional current into a heavy capacitive load while operating under unity gain condition, which is a difficult challenge due to loop stability reasons. For a more detailed explanation of what a TFT panel is and what its amplifier requirements are, please see the Application Notes section of the LM6584 found on the web at: <http://www.national.com/ds.cgi/LM/LM6584.pdf>

Because of the complexity of the TFT  $V_{\text{COM}}$  waveform and the wide variation in characteristics between different TFT panels, it is difficult to decipher the results of circuit testing in an actual panel. The ability to make simplifying assumptions about the load in order to test the amplifier on the bench allows testing using standard equipment and provides familiar results which could be interpreted using standard loop analysis techniques. This is what has been done in this application note with regard to the LMH6640's performance when subjected to the conditions found in a TFT  $V_{\text{COM}}$  application.

Figure 1, shows a typical simplified  $V_{\text{COM}}$  application with the LMH6640 buffering the  $V_{\text{COM}}$  potential (which is usually around  $\frac{1}{2}$  of panel supply voltage) and looking into the simplified model of the load. The load represents the cumulative effect of all stray capacitances between the  $V_{\text{COM}}$  node and both row and column lines. Associated with the capacitances shown, is the distributed resistance of the lines to each individual transistor switch. The other end of this R-C ladder is driven by the column driver in an actual panel and here is driven with a low impedance MOSFET driver (labeled "High Current Driver") for the purposes of this bench test to simulate the effect that the column driver exerts on the  $V_{\text{COM}}$  load.

The modeled TFT  $V_{\text{COM}}$  load, shown in Figure 1, is based on the following simplifying assumptions in order to allow for easy bench testing and yet allow good matching results obtained in the actual application:

- The sum of all the capacitors and resistors in the R-C ladder is the total  $V_{\text{COM}}$  capacitance and resistance respectively. This total varies from panel to panel; capacitance could range from 50 nF-200 nF and the resistance could be anywhere from 20 $\Omega$ -100 $\Omega$ .
- The number of ladder sections has been reduced to a number (4 sections in this case) which can easily be put together in the lab and which behaves reasonably close to the actual load.

In this example, the LMH6640 was tested under the simulated conditions of total 209 nF capacitance and 54 $\Omega$  as shown in Figure 1.

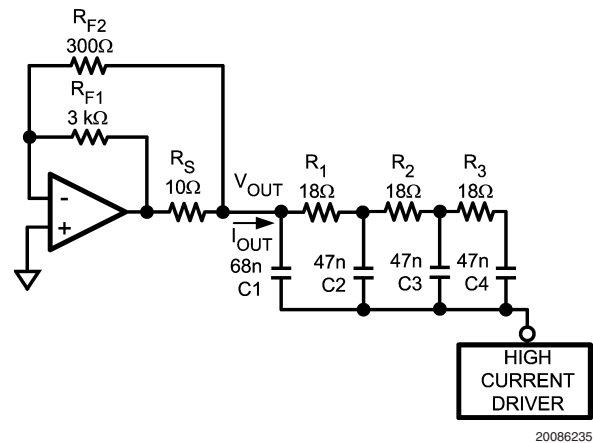

**FIGURE 1. LMH6640 in a  $V_{\text{COM}}$  Buffer Application with Simulated TFT Load**

$R_S$  is sometimes used in the panel to provide additional isolation from the load while  $R_{F2}$  provides a more direct feedback from the  $V_{\text{COM}}$ .  $R_{F1}$ ,  $R_{F2}$ , and  $R_S$  are trimmed in the actual circuit with settling time and stability trade-offs considered and evaluated. When tested under simulated load conditions of Figure 1, here are the resultant voltage and current waveforms at the LMH6640 output:

## Application Notes (Continued)

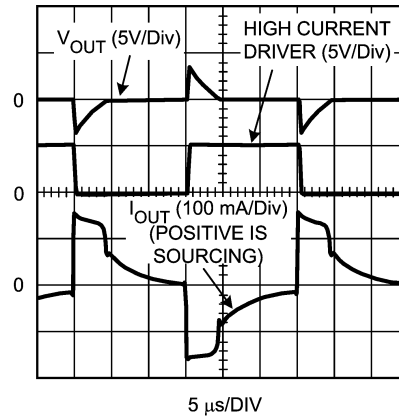

20086236

FIGURE 2.  $V_{COM}$  Output, High Current Drive Waveform, & LMH6640 Output Current Waveforms

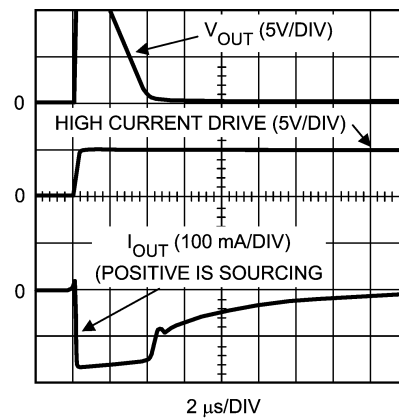

20086237

FIGURE 3. Expanded View of Figure 2 Waveforms showing LMH6640 Current Sinking  $\frac{1}{2}$  Cycle

As can be seen, the LMH6640 is capable of supplying up to 160 mA of output current and can settle the output in 4.4  $\mu$ s. The LMH6640 is a cost effective amplifier for use in the TFT  $V_{COM}$  application and is made even more attractive by its large supply voltage range and high output current. The

combination of all these features is not readily available in the market, especially in the space saving SOT23-5 package. All this performance is achieved at the low power consumption of 65 mW which is of utmost importance in today's battery driven TFT panels.

## Physical Dimensions inches (millimeters)

unless otherwise noted

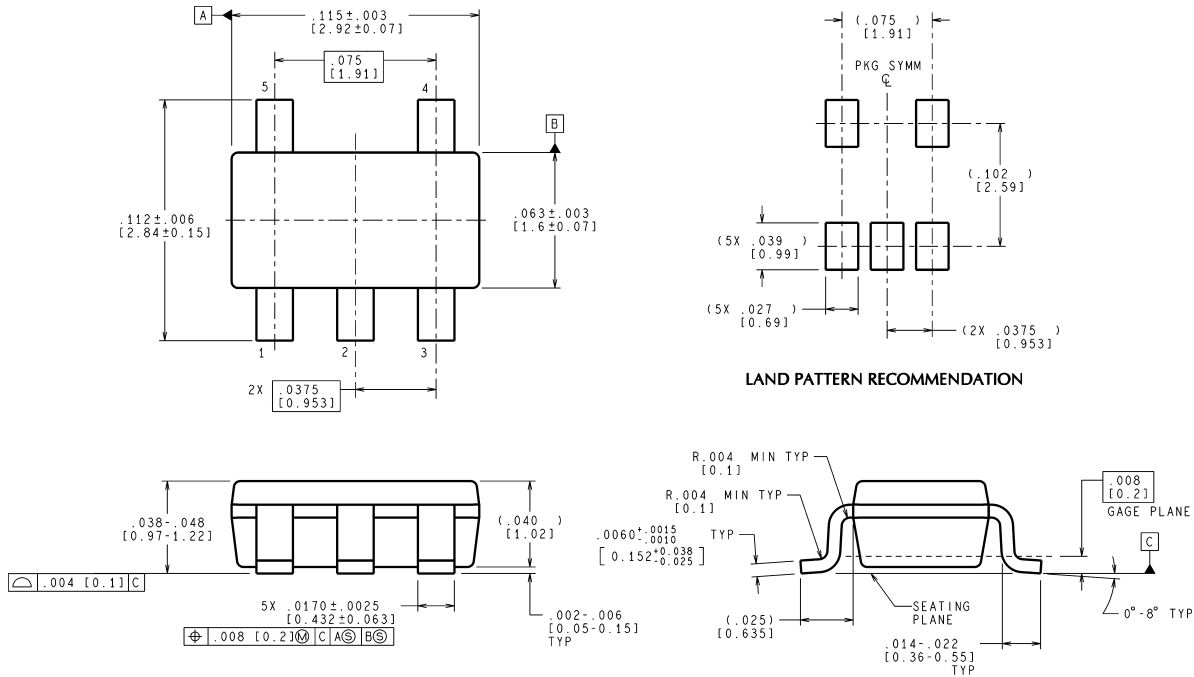

CONTROLLING DIMENSION IS INCH  
VALUES IN [ ] ARE MILLIMETERS

MF05A (Rev B)

**5-Pin SOT23**  
**NS Product Number MF05A**

National does not assume any responsibility for use of any circuitry described, no circuit patent licenses are implied and National reserves the right at any time without notice to change said circuitry and specifications.

For the most current product information visit us at [www.national.com](http://www.national.com).

### LIFE SUPPORT POLICY

NATIONAL'S PRODUCTS ARE NOT AUTHORIZED FOR USE AS CRITICAL COMPONENTS IN LIFE SUPPORT DEVICES OR SYSTEMS WITHOUT THE EXPRESS WRITTEN APPROVAL OF THE PRESIDENT AND GENERAL COUNSEL OF NATIONAL SEMICONDUCTOR CORPORATION. As used herein:

1. Life support devices or systems are devices or systems which, (a) are intended for surgical implant into the body, or (b) support or sustain life, and whose failure to perform when properly used in accordance with instructions for use provided in the labeling, can be reasonably expected to result in a significant injury to the user.
2. A critical component is any component of a life support device or system whose failure to perform can be reasonably expected to cause the failure of the life support device or system, or to affect its safety or effectiveness.

### BANNED SUBSTANCE COMPLIANCE

National Semiconductor certifies that the products and packing materials meet the provisions of the Customer Products Stewardship Specification (CSP-9-111C2) and the Banned Substances and Materials of Interest Specification (CSP-9-111S2) and contain no "Banned Substances" as defined in CSP-9-111S2.



**National Semiconductor**  
**Americas Customer**  
**Support Center**  
Email: [new.feedback@nsc.com](mailto:new.feedback@nsc.com)  
Tel: 1-800-272-9959

**National Semiconductor**  
**Europe Customer Support Center**  
Fax: +49 (0) 180-530 85 86  
Email: [europa.support@nsc.com](mailto:europa.support@nsc.com)  
Deutsch Tel: +49 (0) 69 9508 6208  
English Tel: +44 (0) 870 24 0 2171  
Français Tel: +33 (0) 1 41 91 8790

**National Semiconductor**  
**Asia Pacific Customer**  
**Support Center**  
Email: [ap.support@nsc.com](mailto:ap.support@nsc.com)

**National Semiconductor**  
**Japan Customer Support Center**  
Fax: 81-3-5639-7507  
Email: [jpn.feedback@nsc.com](mailto:jpn.feedback@nsc.com)  
Tel: 81-3-5639-7560

[www.national.com](http://www.national.com)