

# 32K x 16 Static RAM

## Features

- Pin- and function-compatible with CY7C1020V33
- High speed
  - $t_{AA} = 10, 12, 15$  ns
- CMOS for optimum speed/power
- Low active power
  - 360 mW (max.)
- Automatic power-down when deselected
- Independent control of upper and lower bits
- Available in 44-pin TSOP II

## Functional Description

The CY7C1020CV33 is a high-performance CMOS static RAM organized as 32,768 words by 16 bits. This device has an automatic power-down feature that significantly reduces power consumption when deselected.

Writing to the device is accomplished by taking Chip Enable (CE) and Write Enable (WE) inputs LOW. If Byte Low Enable

(BLE) is LOW, then data from I/O pins (I/O<sub>1</sub> through I/O<sub>8</sub>), is written into the location specified on the address pins (A<sub>0</sub> through A<sub>14</sub>). If Byte High Enable (BHE) is LOW, then data from I/O pins (I/O<sub>9</sub> through I/O<sub>16</sub>) is written into the location specified on the address pins (A<sub>0</sub> through A<sub>14</sub>).

Reading from the device is accomplished by taking Chip Enable (CE) and Output Enable (OE) LOW while forcing the Write Enable (WE) HIGH. If Byte Low Enable (BLE) is LOW, then data from the memory location specified by the address pins will appear on I/O<sub>1</sub> to I/O<sub>8</sub>. If Byte High Enable (BHE) is LOW, then data from memory will appear on I/O<sub>9</sub> to I/O<sub>16</sub>. See the truth table at the back of this data sheet for a complete description of read and write modes.

The input/output pins (I/O<sub>1</sub> through I/O<sub>16</sub>) are placed in a high-impedance state when the device is deselected (CE HIGH), the outputs are disabled (OE HIGH), the BHE and BLE are disabled (BHE, BLE HIGH), or during a write operation (CE LOW, and WE LOW).

The CY7C1020CV33 is available in standard 44-pin TSOP Type II packages.

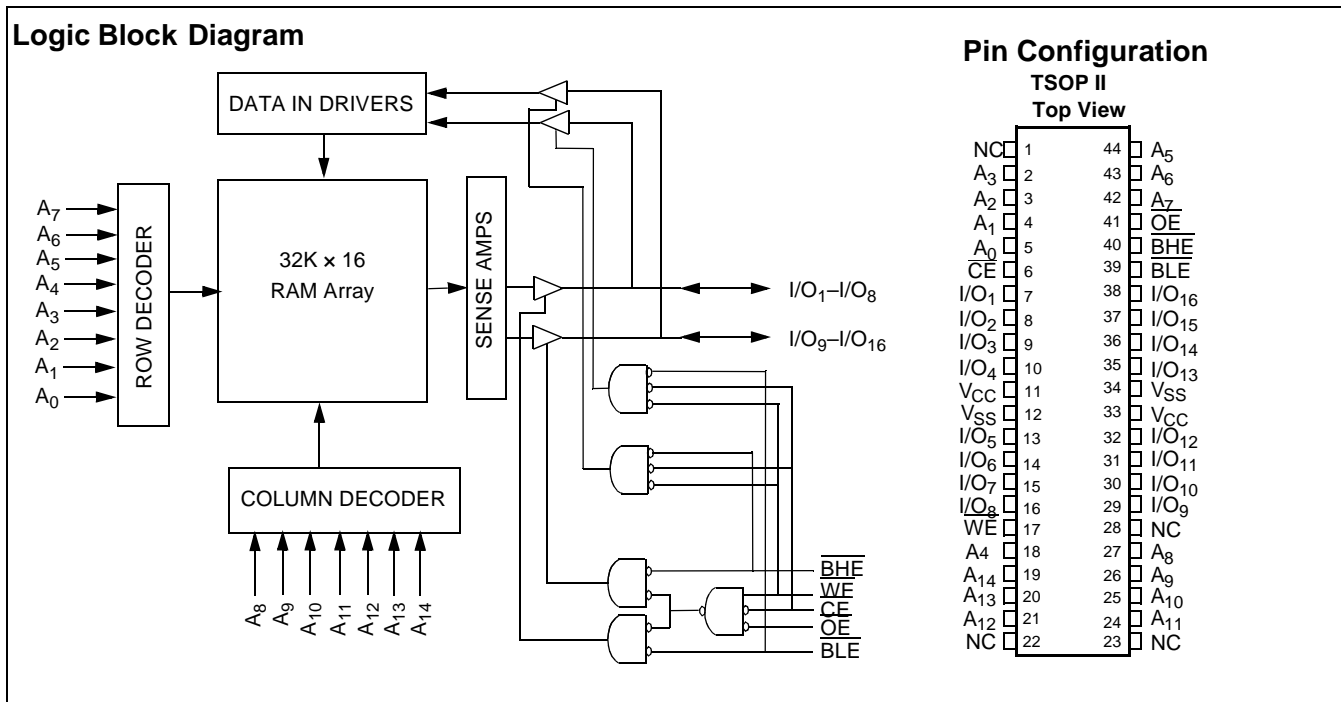

## Selection Guide

	1020CV33-10	1020CV33-12	1020CV33-15	Unit
Maximum Access Time	10	12	15	ns
Maximum Operating Current	90	85	80	mA
Maximum CMOS Standby Current	5	5	5	mA

### Maximum Ratings

(Above which the useful life may be impaired. For user guidelines, not tested.)

Storage Temperature ..... -65°C to +150°C  
 Ambient Temperature with Power Applied ..... -55°C to +125°C  
 Supply Voltage on V<sub>CC</sub> to Relative GND<sup>[1]</sup> .... -0.5V to +4.6V  
 DC Voltage Applied to Outputs in High-Z State<sup>[1]</sup> ..... -0.5V to V<sub>CC</sub> + 0.5V

DC Input Voltage<sup>[1]</sup> ..... -0.5V to V<sub>CC</sub> + 0.5V  
 Current into Outputs (LOW) ..... 20 mA  
 Static Discharge Voltage ..... > 2001V (per MIL-STD-883, Method 3015)  
 Latch-up Current ..... > 200 mA

### Operating Range

Range	Ambient Temperature	V <sub>CC</sub>
Commercial	0°C to +70°C	3.3V ± 10%
Industrial	-40°C to +85°C	3.3V ± 10%

### Electrical Characteristics Over the Operating Range

Parameter	Description	Test Conditions	1020CV33-10		1020CV33-12		1020CV33-15		Unit
			Min.	Max.	Min.	Max.	Min.	Max.	
V <sub>OH</sub>	Output HIGH Voltage	V <sub>CC</sub> = Min., I <sub>OH</sub> = -4.0 mA	2.4		2.4		2.4		V
V <sub>OL</sub>	Output LOW Voltage	V <sub>CC</sub> = Min., I <sub>OL</sub> = 8.0 mA		0.4		0.4		0.4	V
V <sub>IH</sub>	Input HIGH Voltage		2.0	V <sub>CC</sub> + 0.3	2.0	V <sub>CC</sub> + 0.3	2.0	V <sub>CC</sub> + 0.3	V
V <sub>IL</sub>	Input LOW Voltage <sup>[1]</sup>		-0.3	0.8	-0.3	0.8	-0.3	0.8	V
I <sub>IX</sub>	Input Load Current	GND ≤ V <sub>I</sub> ≤ V <sub>CC</sub>	-1	+1	-1	+1	-1	+1	µA
I <sub>OZ</sub>	Output Leakage Current	GND ≤ V <sub>I</sub> ≤ V <sub>CC</sub> , Output Disabled	-1	+1	-1	+1	-1	+1	µA
I <sub>OS</sub> <sup>[2]</sup>	Output Short Circuit Current	V <sub>CC</sub> = Max., V <sub>OUT</sub> = GND		-300		-300		-300	mA
I <sub>CC</sub>	V <sub>CC</sub> Operating Supply Current	V <sub>CC</sub> = Max., I <sub>OUT</sub> = 0 mA, f = f <sub>MAX</sub> = 1/t <sub>RC</sub>		90		85		80	mA
I <sub>SB1</sub>	Automatic CE Power-down Current —TTL Inputs	Max. V <sub>CC</sub> , CE ≥ V <sub>IH</sub> , V <sub>IN</sub> ≥ V <sub>IH</sub> or V <sub>IN</sub> ≤ V <sub>IL</sub> , f = f <sub>MAX</sub>		15		15		15	mA
I <sub>SB2</sub>	Automatic CE Power-down Current —CMOS Inputs	Max. V <sub>CC</sub> , CE ≥ V <sub>CC</sub> - 0.3V, V <sub>IN</sub> ≥ V <sub>CC</sub> - 0.3V, or V <sub>IN</sub> ≤ 0.3V, f = 0		5		5		5	mA

### Capacitance<sup>[3]</sup>

Parameter	Description	Test Conditions	Max.	Unit
C <sub>IN</sub>	Input Capacitance	T <sub>A</sub> = 25°C, f = 1 MHz, V <sub>CC</sub> = 3.3V	8	pF
C <sub>OUT</sub>	Output Capacitance		8	pF

#### Notes:

- V<sub>IL</sub> (min.) = -2.0V for pulse durations of less than 20 ns.
- Not more than one output should be shorted at one time. Duration of the short circuit should not exceed 30 seconds.
- Tested initially and after any design or process changes that may affect these parameters.

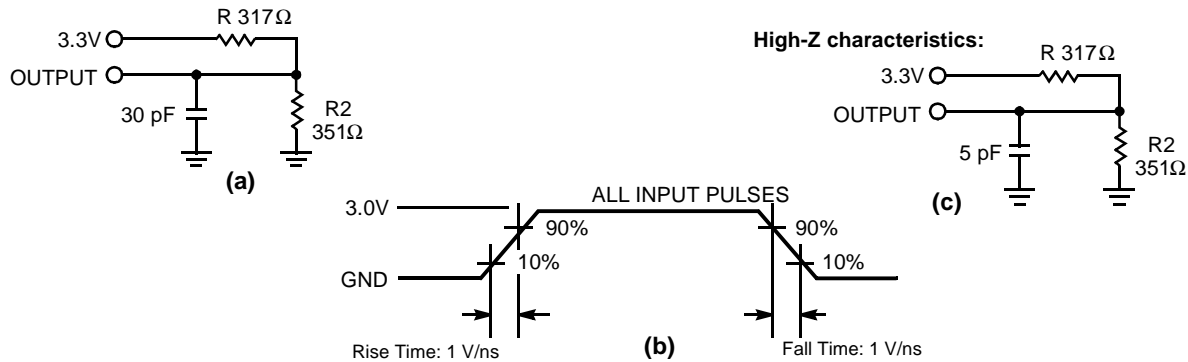
**AC Test Loads and Waveforms<sup>[4]</sup>**

**Switching Characteristics Over the Operating Range<sup>[4]</sup>**

Parameter	Description	1020CV33-10		1020CV33-12		1020CV33-15		Unit
		Min.	Max.	Min.	Max.	Min.	Max.	
<b>Read Cycle</b>								
$t_{RC}$	Read Cycle Time	10		12		15		ns
$t_{AA}$	Address to Data Valid		10		12		15	ns
$t_{OHA}$	Data Hold from Address Change	3		3		3		ns
$t_{ACE}$	CE LOW to Data Valid		10		12		15	ns
$t_{DOE}$	OE LOW to Data Valid		5		6		7	ns
$t_{LZOE}$	OE LOW to Low-Z <sup>[5]</sup>	0		0		0		ns
$t_{HZOE}$	OE HIGH to High-Z <sup>[5, 6]</sup>		5		6		7	ns
$t_{LZCE}$	CE LOW to Low-Z <sup>[5]</sup>	3		3		3		ns
$t_{HZCE}$	CE HIGH to High-Z <sup>[5, 6]</sup>		5		6		7	ns
$t_{PU}^{[7]}$	CE LOW to Power-up	0		0		0		ns
$t_{PD}^{[7]}$	CE HIGH to Power-down		10		12		15	ns
$t_{DBE}$	Byte Enable to Data Valid		5		6		7	ns
$t_{LZBE}$	Byte Enable to Low-Z	0		0		0		ns
$t_{HZBE}$	Byte Disable to High-Z		5		6		7	ns
<b>Write Cycle<sup>[8]</sup></b>								
$t_{WC}$	Write Cycle Time	10		12		15		ns
$t_{SCE}$	CE LOW to Write End	8		9		10		ns
$t_{AW}$	Address Set-up to Write End	7		8		10		ns
$t_{HA}$	Address Hold from Write End	0		0		0		ns
$t_{SA}$	Address Set-up to Write Start	0		0		0		ns
$t_{PWE}$	WE Pulse Width	7		8		10		ns
$t_{SD}$	Data Set-up to Write End	5		6		8		ns
$t_{HD}$	Data Hold from Write End	0		0		0		ns
$t_{LZWE}$	WE HIGH to Low-Z <sup>[5]</sup>	3		3		3		ns
$t_{HZWE}$	WE LOW to High-Z <sup>[5, 6]</sup>		5		6		7	ns
$t_{BW}$	Byte Enable to End of Write	7		8		9		ns

**Notes:**

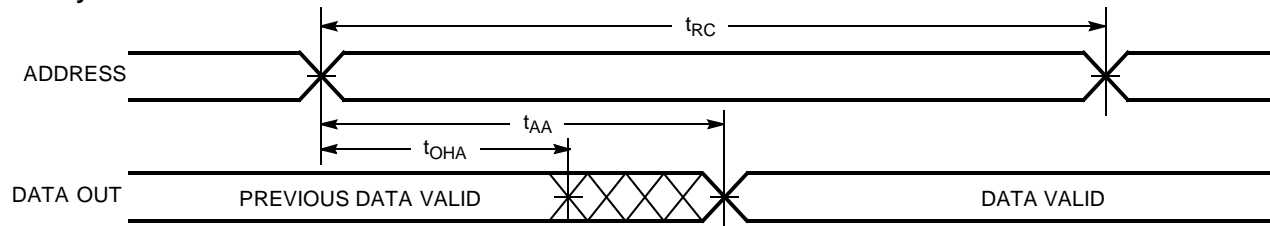
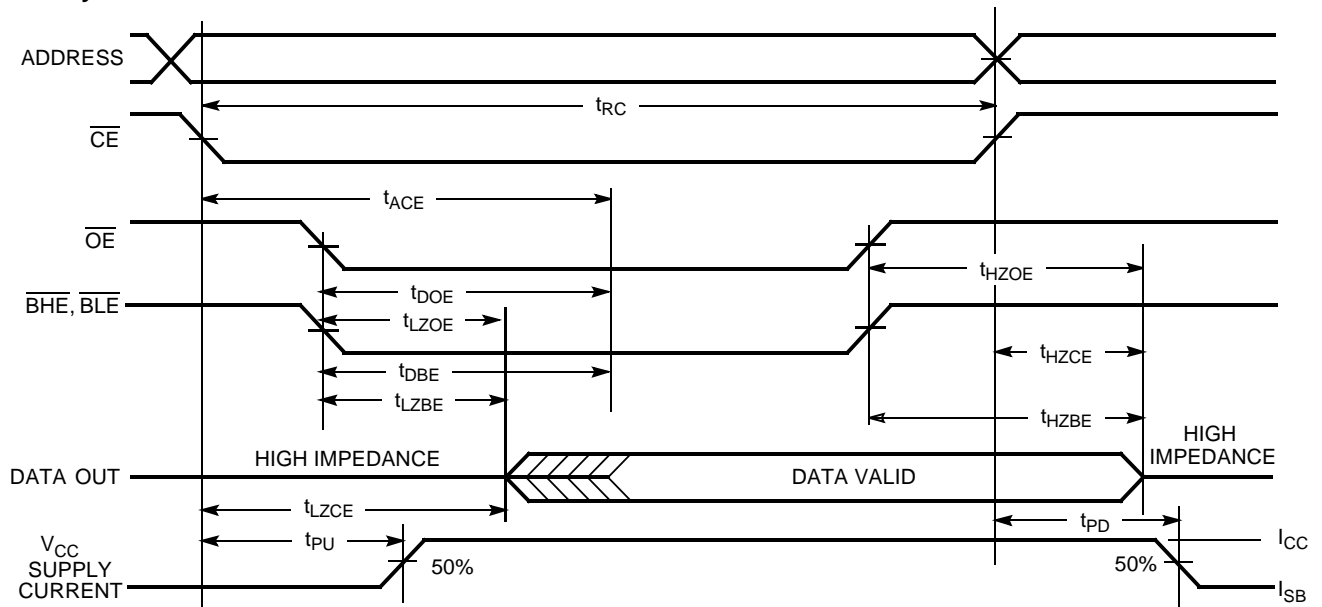
- Test conditions assume signal transition time of 3 ns or less, timing reference levels of 1.5V, input pulse levels of 0 to 3.0V.
- At any given temperature and voltage condition,  $t_{HZCE}$  is less than  $t_{LZCE}$ ,  $t_{HZOE}$  is less than  $t_{LZOE}$ , and  $t_{HZWE}$  is less than  $t_{LZWE}$  for any given device.
- $t_{HZOE}$ ,  $t_{HZBE}$ ,  $t_{HZCE}$ , and  $t_{HZWE}$  are specified with a load capacitance of 5 pF as in part (c) of AC Test Loads. Transition is measured  $\pm 500$  mV from steady-state voltage.
- This parameter is guaranteed by design and is not tested.
- The internal Write time of the memory is defined by the overlap of  $\overline{CE}$  LOW,  $\overline{WE}$  LOW and  $\overline{BHE} / \overline{BLE}$  LOW.  $\overline{CE}$ ,  $\overline{WE}$  and  $\overline{BHE} / \overline{BLE}$  must be LOW to initiate a Write, and the transition of these signals can terminate the Write. The input data set-up and hold timing should be referenced to the leading edge of the signal that terminates the Write.

**Switching Waveforms**
**Read Cycle No. 1** [9, 10]

**Read Cycle No. 2 ( $\overline{OE}$  Controlled)** [10, 11]

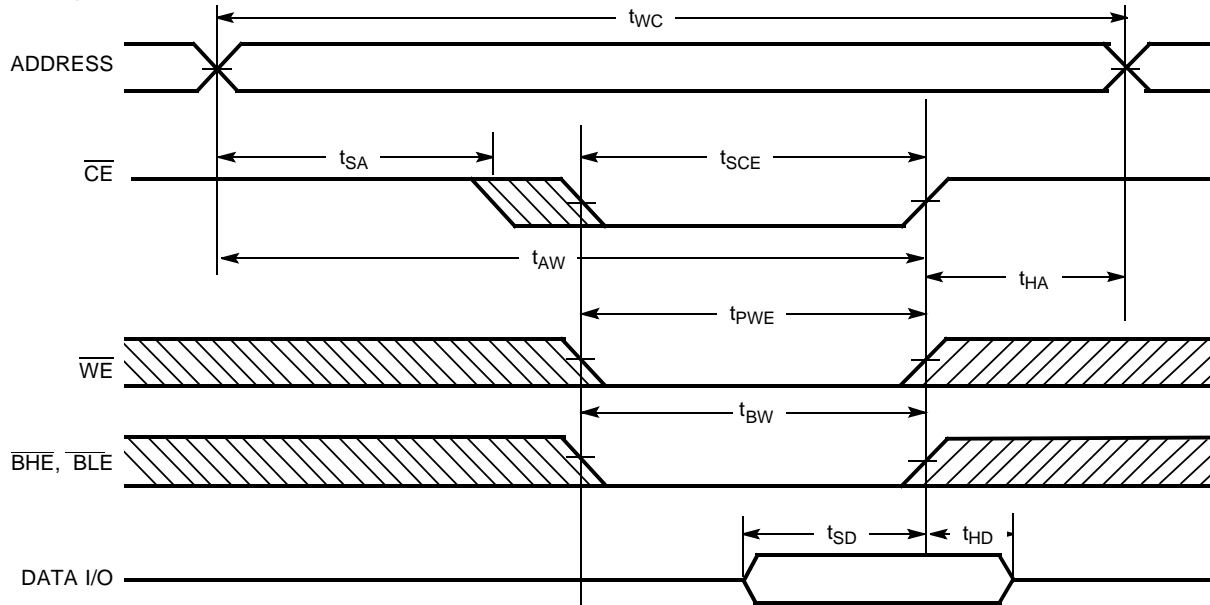
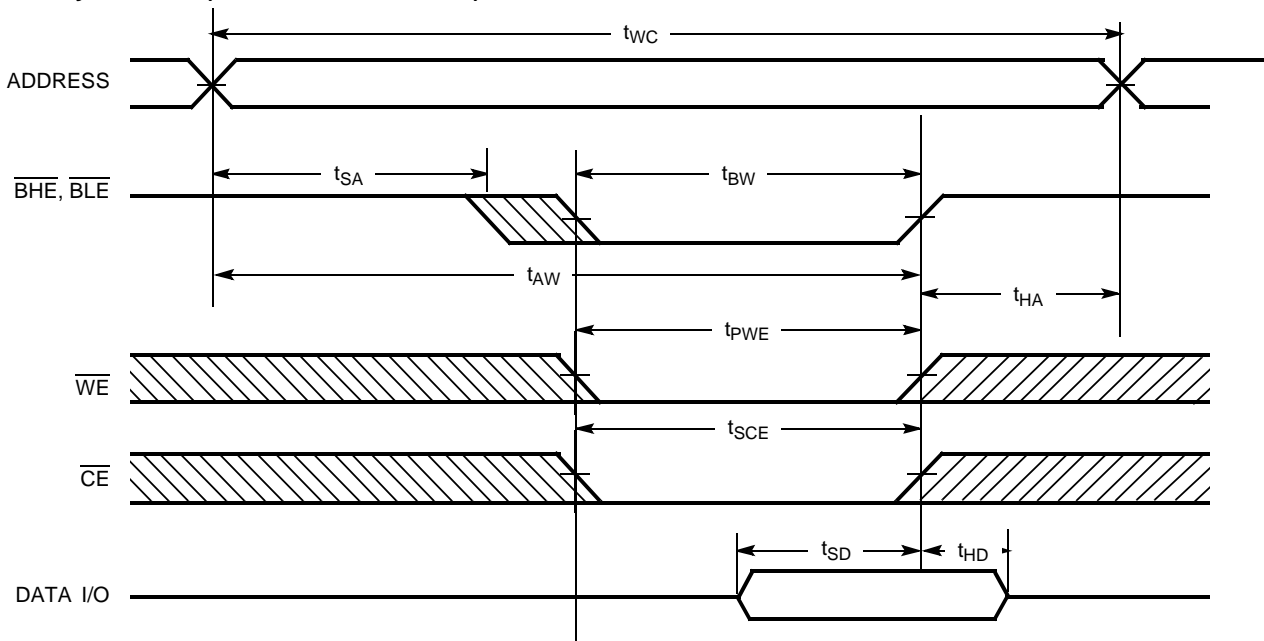
**Notes:**

9. Device is continuously selected.  $\overline{OE}$ ,  $\overline{CE}$ ,  $\overline{BHE}$  and/or  $\overline{BLE}$  =  $V_{IL}$ .
10.  $\overline{WE}$  is HIGH for Read cycle.
11. Address valid prior to or coincident with  $\overline{CE}$  transition LOW.

**Switching Waveforms (continued)**
**Write Cycle No. 1 ( $\overline{\text{CE}}$  Controlled) [12, 13]**

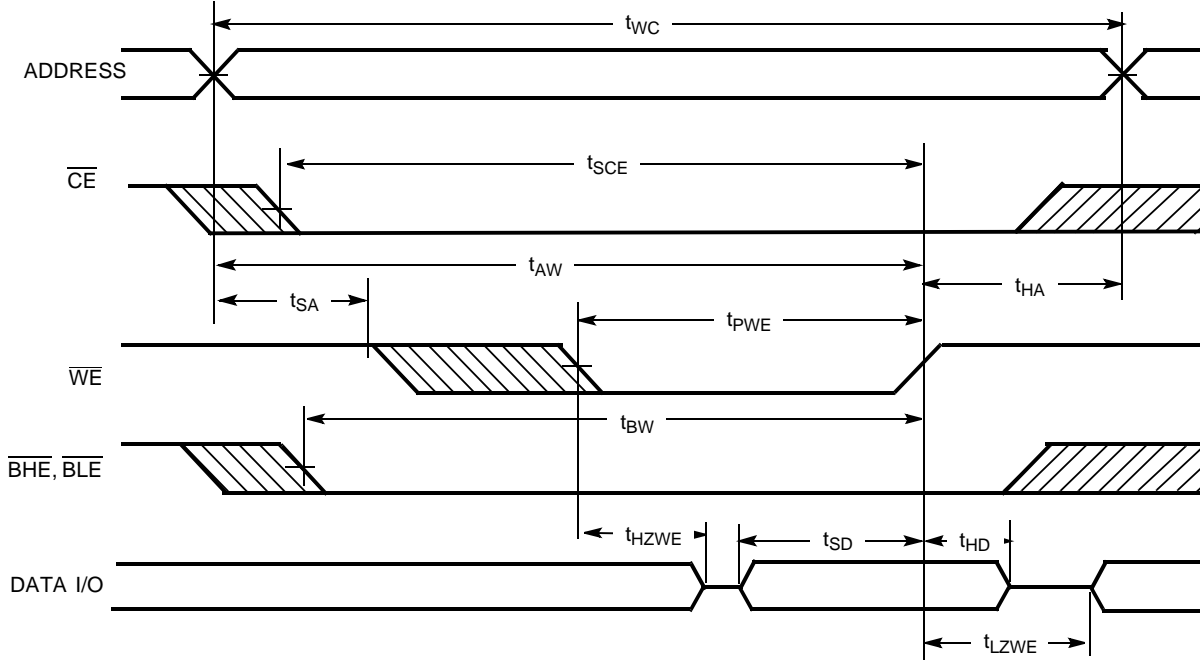
**Write Cycle No. 2 ( $\overline{\text{BLE}}$  or  $\overline{\text{BHE}}$  Controlled)**

**Notes:**

12. Data I/O is high impedance if  $\overline{\text{OE}}$  or  $\overline{\text{BHE}}$  and/or  $\overline{\text{BLE}} = V_{\text{IH}}$ .
13. If  $\overline{\text{CE}}$  goes HIGH simultaneously with  $\overline{\text{WE}}$  going HIGH, the output remains in a high-impedance state.

**Switching Waveforms** (continued)

**Write Cycle No. 3 ( $\overline{WE}$  Controlled)**

**Truth Table**

CE	OE	WE	BLE	BHE	I/O <sub>1</sub> –I/O <sub>8</sub>	I/O <sub>9</sub> –I/O <sub>16</sub>	Mode	Power
H	X	X	X	X	High-Z	High-Z	Power-down	Standby ( $I_{SB}$ )
L	L	H	L	L	Data Out	Data Out	Read—All bits	Active ( $I_{CC}$ )
			L	H	Data Out	High-Z	Read—Lower bits only	Active ( $I_{CC}$ )
			H	L	High-Z	Data Out	Read—Upper bits only	Active ( $I_{CC}$ )
L	X	L	L	L	Data In	Data In	Write—All bits	Active ( $I_{CC}$ )
			L	H	Data In	High-Z	Write—Lower bits only	Active ( $I_{CC}$ )
			H	L	High-Z	Data In	Write—Upper bits only	Active ( $I_{CC}$ )
L	H	H	X	X	High-Z	High-Z	Selected, Outputs Disabled	Active ( $I_{CC}$ )
L	X	X	H	H	High-Z	High-Z	Selected, Outputs Disabled	Active ( $I_{CC}$ )

**Ordering Information**

Speed (ns)	Ordering Code	Package Name	Package Type	Operating Range
10	CY7C1020CV33-10ZC	Z44	44-lead TSOP Type II	Commercial
	CY7C1020CV33-10ZI	Z44	44-lead TSOP Type II	Industrial
12	CY7C1020CV33-12ZC	Z44	44-lead TSOP Type II	Commercial
	CY7C1020CV33-12ZI	Z44	44-lead TSOP Type II	Industrial
15	CY7C1020CV33-15ZC	Z44	44-lead TSOP Type II	Commercial
	CY7C1020CV33-15ZI	Z44	44-lead TSOP Type II	Industrial

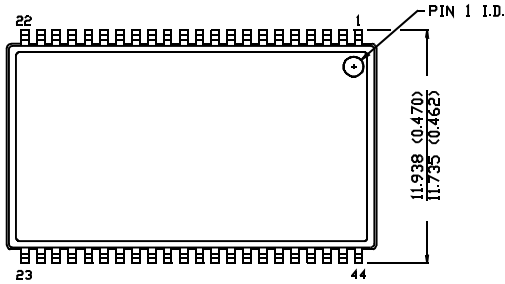
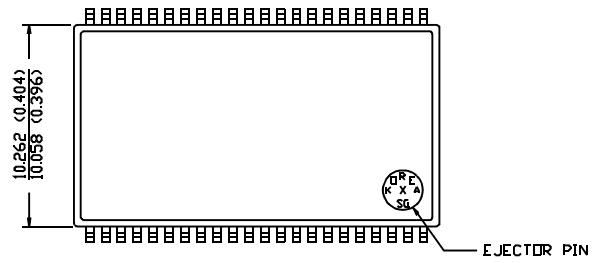
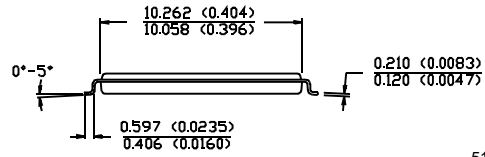
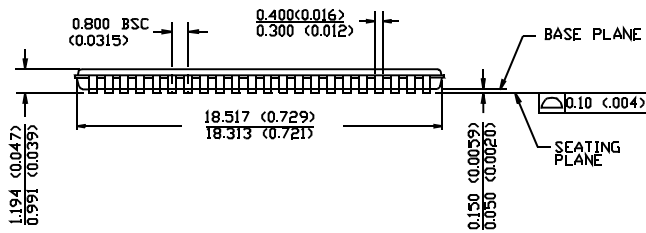
**Package Diagrams**
**44-Pin TSOP II Z44**

 DIMENSION IN MM (INCH)  
 MAX  
 MIN.

**TOP VIEW**

**BOTTOM VIEW**

51-85087-A

All products and company names mentioned in this document may be the trademarks of their respective holders.

Document Title: CY7C1020CV33 32K x 16 Static RAM  
Document Number: 38-05133

REV.	ECN NO.	Issue Date	Orig. of Change	Description of Change
**	109428	12/16/01	HGK	New Data Sheet
*A	115045	05/30/02	HGK	I <sub>CC</sub> and I <sub>SB1</sub> data modified
*B	117615	08/14/02	DFP	Pin 1= NC Pin 18 = A4; remove SOJ package option; remove 8ns option.