

5W AUDIO AMPLIFIER WITH MUTING AND STAND-BY

- MUTING AND STAND-BY FUNCTIONS
- VOLTAGE RANGE UP TO 30V
- HIGH SUPPLY VOLTAGE REJECTION
SVR TYP = 50dB (f = 100Hz)
- MUSIC POWER = 12W (R_L = 4Ω, d = 10%)
- PROTECTION AGAINST CHIP OVER TEMPERATURE

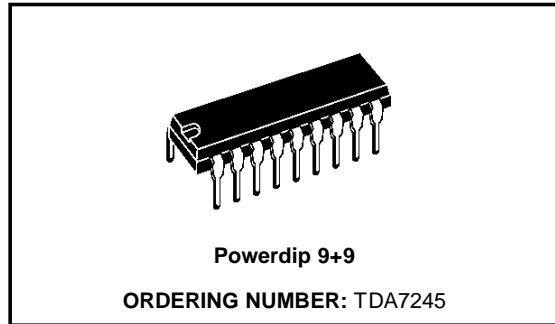

DESCRIPTION

The TDA7245 is a monolithic integrated circuit in 9+9 POWERDIP package, intended for use as

low frequency power amplifier in a wide range of applications in radio and TV sets.

Figure 1: Test and Application Circuit

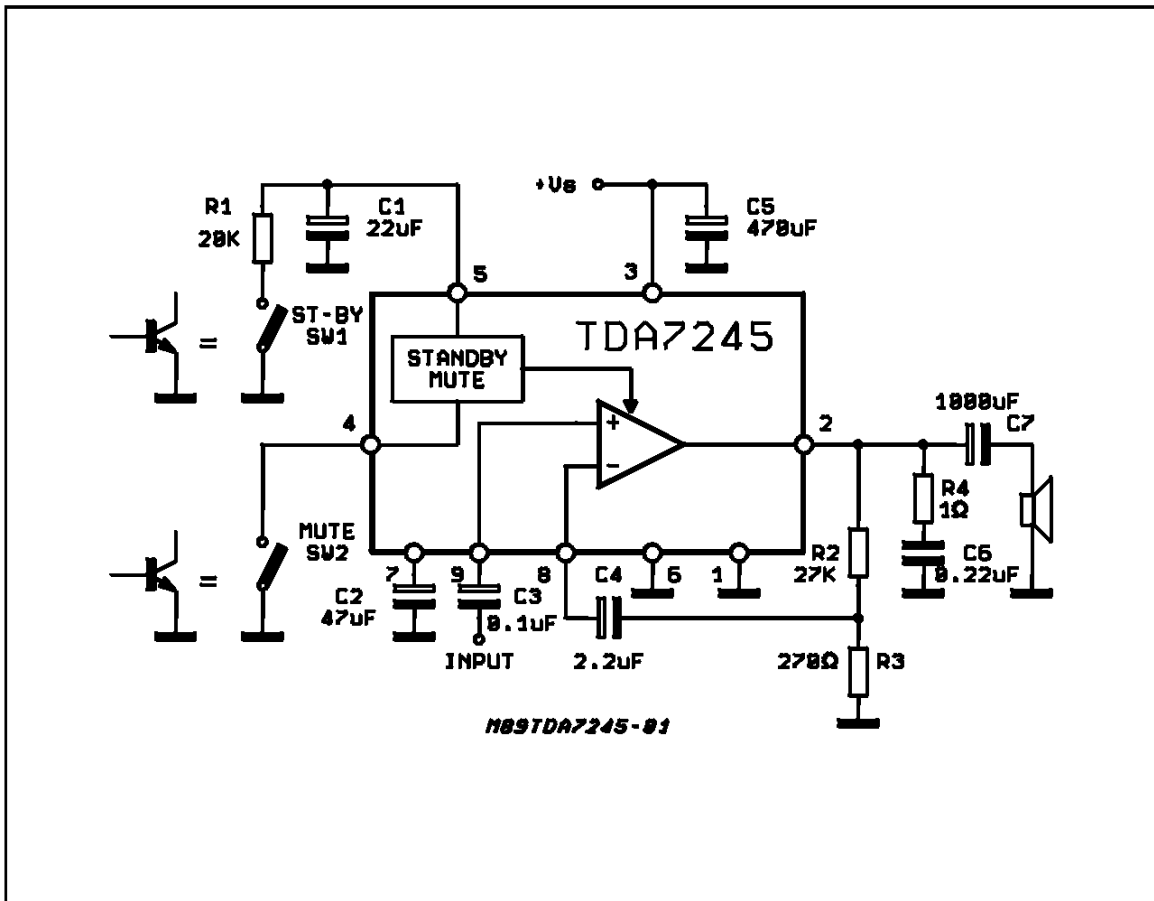

TDA7245

ABSOLUTE MAXIMUM RATINGS

Symbol	Parameter	Value	Unit
V_S	Supply Voltage	30	V
I_O	Output Peak Current (non repetitive $t = 100\mu s$)	3	A
I_O	Output Peak Current (repetitive, $f > 20Hz$)	2.5	A
P_{tot}	Power Dissipation at $T_{amb} = 80^\circ C$	1	W
	at $T_{case} = 70^\circ C$	6	W
T_{stg}, T_j	Storage and junction Temperature	-40 to 150	$^\circ C$

PIN CONNECTION (Top view)

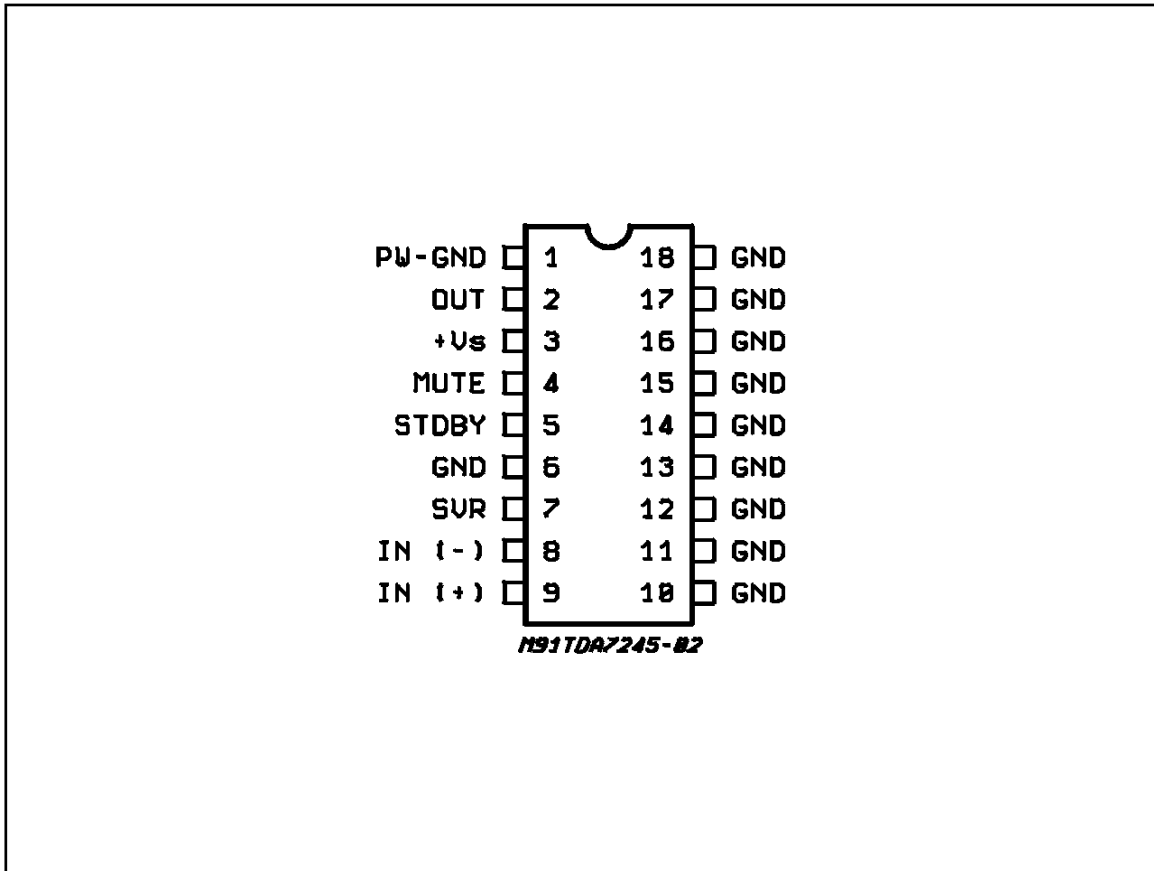

THERMAL DATA

Symbol	Description	Value	Unit
$R_{th\ j-case}$	Thermal Resistance junction-case	Max 15	$^\circ C/W$
$R_{th\ j-amb}$	Thermal Resistance junction-ambient	Max 70	$^\circ C/W$

ELECTRICAL CHARACTERISTICS (Refer to the test circuit, $T_{amb} = 25^{\circ}\text{C}$, $f = 1\text{kHz}$; unless otherwise specified).

Symbol	Parameter	Test Condition	Min.	Typ.	Max.	Unit
V_S	Supply Voltage		12		30	V
V_O	Quiescent Output Voltage	$V_S = 24\text{V}$		11.6		V
I_d	Quiescent Drain Current	$V_S = 14\text{V}$ $V_S = 28\text{V}$		17 21	35	mA mA
P_O	Output Power	$d = 1\%$, $f = 1\text{KHz}$ $V_S = 14\text{V}$, $R_L = 4\Omega$ $V_S = 18\text{V}$, $R_L = 8\Omega$		4 4		W W
		$d = 10\%$, $f = 1\text{KHz}$ $V_S = 14\text{V}$, $R_L = 4\Omega$ $V_S = 18\text{V}$, $R_L = 8\Omega$	4	5 5		W W
		Music Power (*) $V_S = 24\text{V}$, $d = 10\%$, $R_L = 4\Omega$		12		W
d	Harmonic Distortion	$V_S = 14\text{V}$, $R_L = 4\Omega$, $P_O = 50\text{mW}$ to 3W $f = 1\text{KHz}$ $f = 10\text{KHz}$		0.15 0.8	0.5	% %
		$V_S = 18\text{V}$, $R_L = 8\Omega$, $P_O = 50\text{mW}$ to 3.5W $f = 1\text{KHz}$ $f = 10\text{KHz}$		0.12 0.5		% %
		$V_S = 22\text{V}$, $R_L = 16\Omega$, $P_O = 50\text{mW}$ to 3W $f = 1\text{KHz}$ $f = 10\text{KHz}$		0.08 0.4		% %
R_I	Input Impedance	$f = 1\text{kHz}$	30			$\text{k}\Omega$
BW	Small signal bandwidth (-3dB)	$P_O = 1\text{W}$; $R_L = 4\Omega$ $V_S = 14\text{V}$	50 to 40,000			Hz
G_V	Voltage Gain (open loop)	$f = 1\text{kHz}$		75		dB
G_V	Voltage Gain (closed loop)	$f = 1\text{kHz}$	39	40	41	dB
e_N	Total Input Noise	$B = 22 - 22,000\text{Hz}$ $R_s = 50\Omega$ $R_s = 1\text{k}\Omega$ $R_s = 10\text{k}\Omega$		1.7 2 3	6	mV μV μV
S/N	Signal to Noise Ratio	$V_S = 18\text{V}$; $R_L = 8\Omega$ $P_O = 5\text{W}$; $R_s = 10\text{k}\Omega$		86		dB
SVR	Supply Voltage Rejection	$V_S = 16.5\text{V}$; $R_L = 8\Omega$; $f = 100\text{Hz}$ $R_s = 10\text{k}\Omega$; $V_r = 0.5\text{Vrms}$	40	50		dB
T_{sd}	Thermal shut-down Junction Temperature			150		$^{\circ}\text{C}$

MUTE FUNCTION

Symbol	Parameter	Test Condition	Min.	Typ.	Max.	Unit
V_m	Pin 4 DC Voltage	Mute SW Open (play)		6.4		V
ATT_m	Muting Attenuation	$f = 100\text{Hz}$ to 10kHz	60	65		dB

ELECTRICAL CHARACTERISTICS (Continued)

STAND-BY FUNCTION

Symbol	Parameter	Test Condition	Min.	Typ.	Max.	Unit
V_{st-by}	Pin 5 DC Voltage	Mute SW Open (play)		6.4		V
I_{st-by}	Pin 5 Current	Mute SW Closed (st-by)		160	280	μ A
ATT_{st-by}	Stand-by Attenuation	f = 100Hz to 10kHz	70	90		dB
V_t	Stand-by Threshold (pin 5)			3.8		V
$I_{d\ st-by}$	Stand-by Current	$V_S = 14V$		1	3	mA

Note (*):

MUSIC POWER CONCEPT

MUSIC POWER is (according to the IEC clauses n.268-3 of Jan 83) the maximal power which the amplifier is capable of producing across the rated load resistance (regardless of non linearity) 1 sec after the application of a sinusoidal input signal of frequency 1KHz.

According to this definition our method of measurement comprises the following steps:

- 1) Set the voltage supply at the maximum operating value -20%
- 2) Apply a input signal in the form of a 1KHz tone burst of 1 sec duration; the repetition period of the signal pulses is > 60 sec
- 3) The output voltage is measured 1 sec from the start of the pulse
- 4) Increase the input voltage until the output signal show a THD = 10%
- 5) The music power is then $V_{out}^2/R1$, where V_{out} is the output voltage measured in the condition of point 4) and R1 is the rated load impedance

The target of this method is to avoid excessive dissipation in the amplifier.

Figure 2: Schematic Diagram

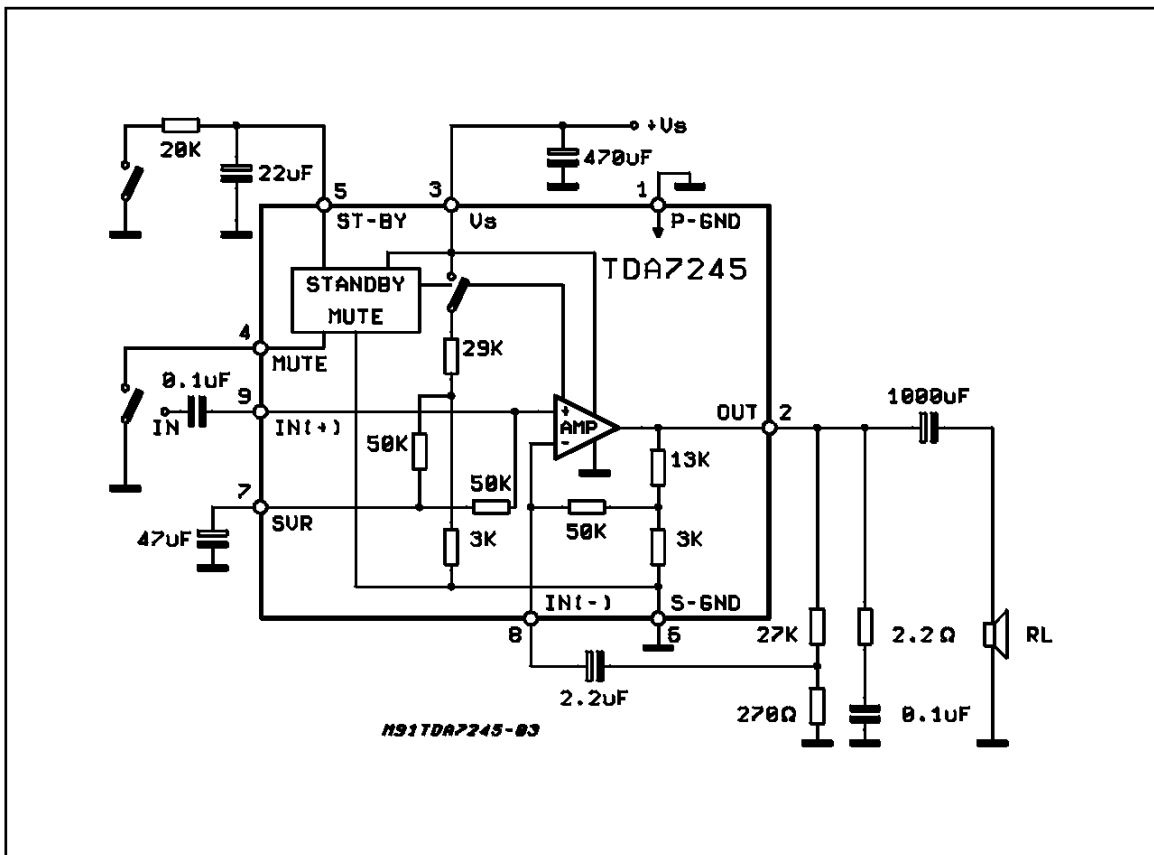
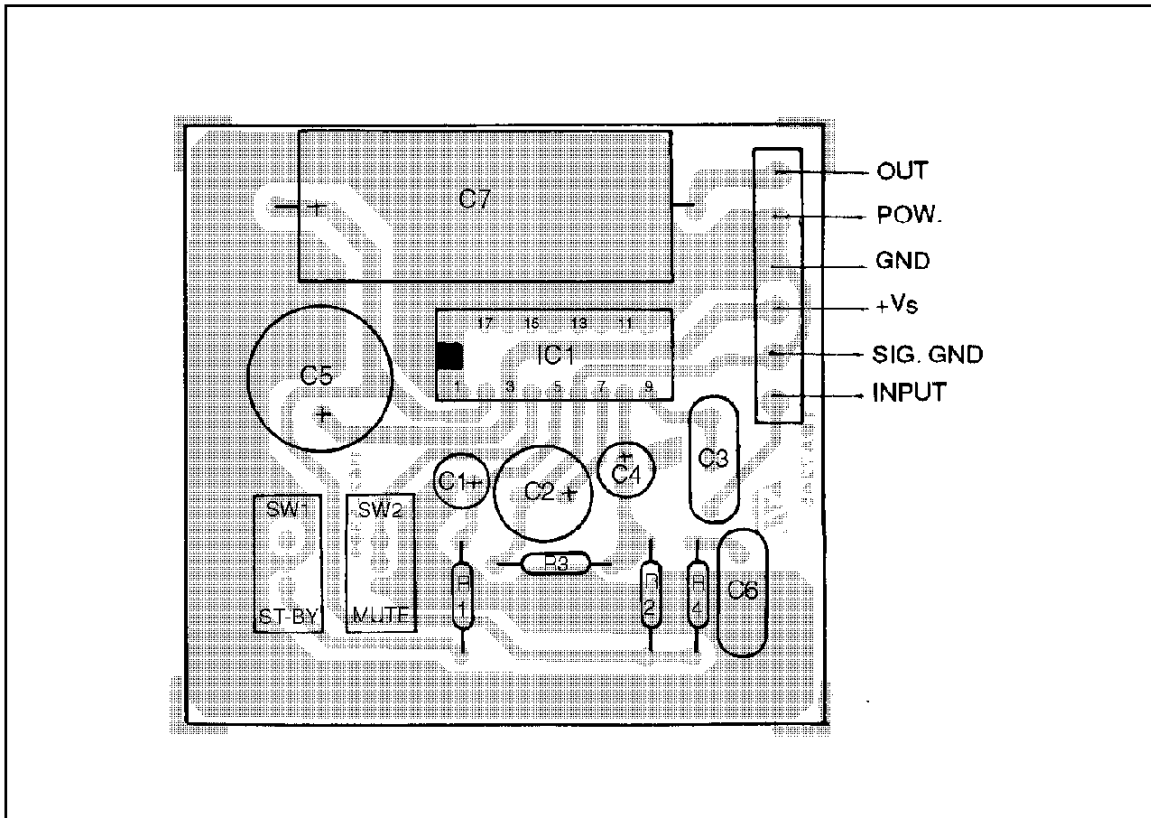

Figure 3: P.C. Board and Components Layout of the Circuit of fig 2 (1:1 scale)



APPLICATION SUGGESTIONS

The recommended values of the external components are those shown on the application circuit of fig.1. Different values can be used. The following table can help the designer.

Component	Rec. Value	Purpose	Larger than Rec. Value	Smaller than Rec. Value
R1	20K Ω	St-By Biasing	Incorrect St-By Function	Worse POP and Shorter Delay at St-By Insertion
R2(*)	27K Ω	Feedback Resistors	Increase of Gain	Decrease of Gain
R3(*)	270 Ω		Decrease of Gain	Increase of Gain
R4	1 Ω	Frequency Stability	Danger of Oscillations	
C1	22 μ F	St-By Capacitor	Longer ON/OFF Delay Time at St-By IN/OUT	Worse POP and Shorter Delay at St-By insertion
C2	47 μ F	SVR Capacitor	Worse Turn-On POP by Vs and St-By	Degradation of SVR
C3	0.1 μ F	Input Capacitance		Higher Low Frequency Cut-off
C4	2.2 μ F	Inverting Input DC Decoupling		Higher Low Frequency Cut-off
C5	470 μ F	Supply Voltage		Danger of Oscillations
C6	0.22 μ F	Frequency Stability	Danger of Oscillations	
C7	1000 μ F	Output DC Decoupling		Higher Low Frequency Cut-off

(*) The value of closed loop gain ($G_v = 1 + R_2/R_3$) must be higher than 25dB.

Figure 4: DC Output Voltage vs. Supply Voltage

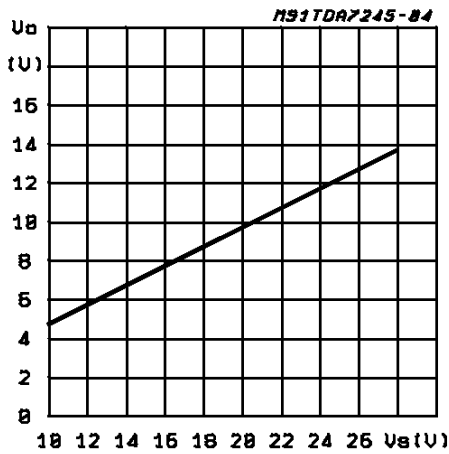

Figure 5: I_D vs. Supply Voltage

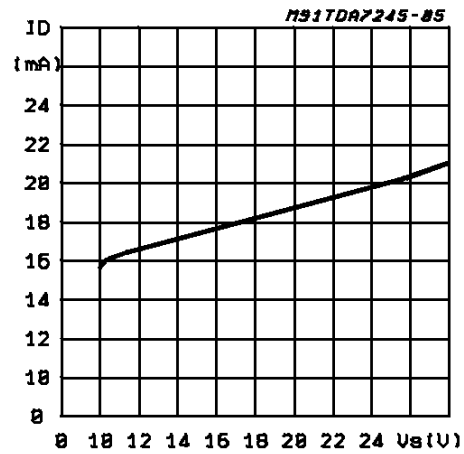

Figure 6: Output Power vs. Supply Voltage

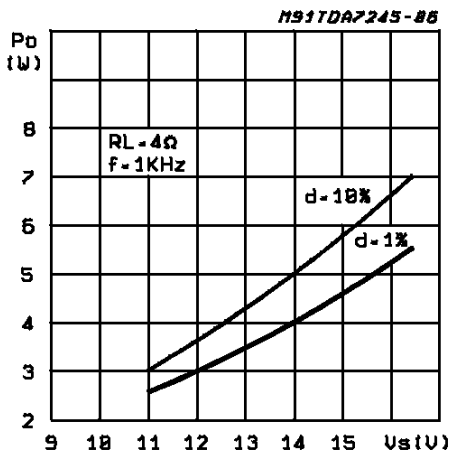

Figure 7: Output Power vs. Supply Voltage

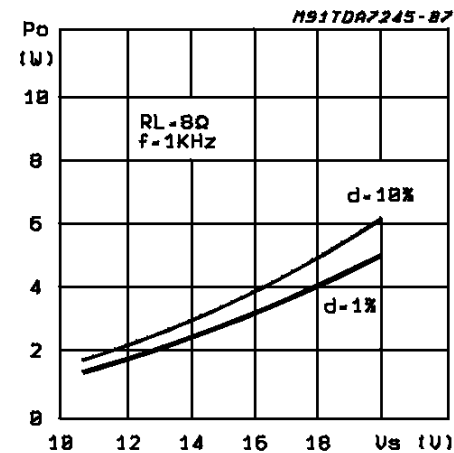

Figure 8: Output Power vs. Supply Voltage

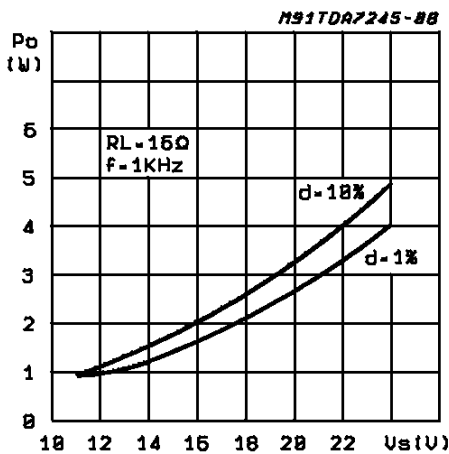

Figure 9: Distortion vs. Output Power

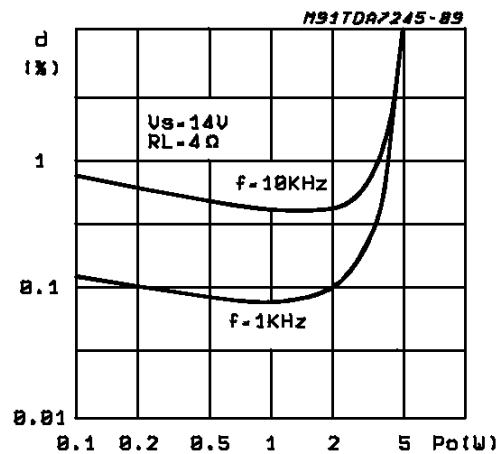

Figure 10: Distortion vs. Output Power

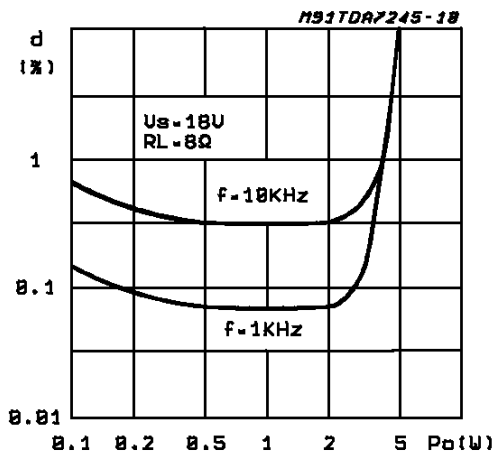

Figure 11: Distortion vs. Output Power

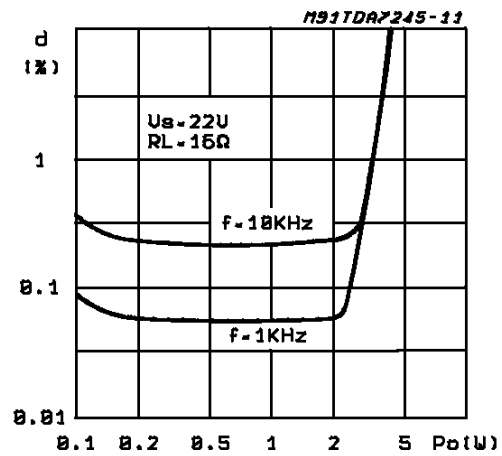

Figure 12: Supply Voltage Rejection vs. Frequency (play)

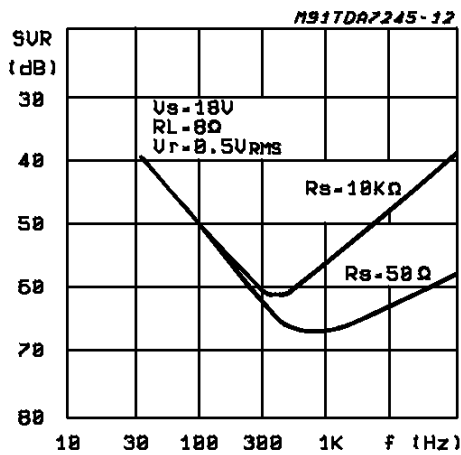

Figure 13: Power Dissipation & Efficiency vs. Output Power

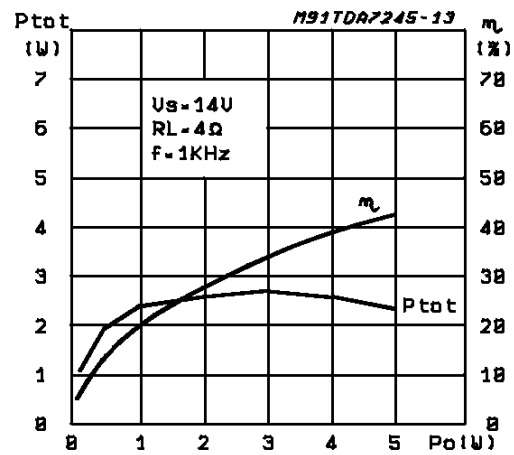

Figure 14: Power Dissipation & Efficiency vs. Output Power

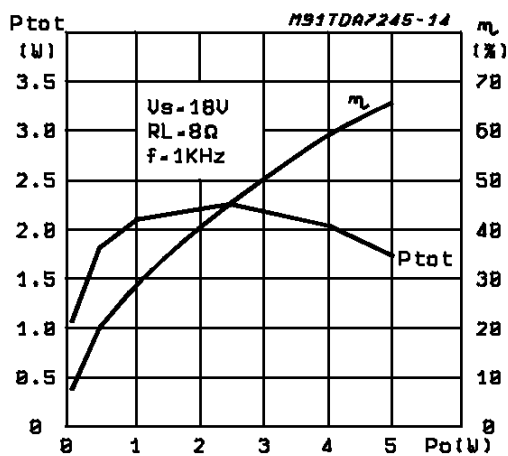

Figure 15: V_{pin5} (= V_{pin4}) vs. Supply Voltage

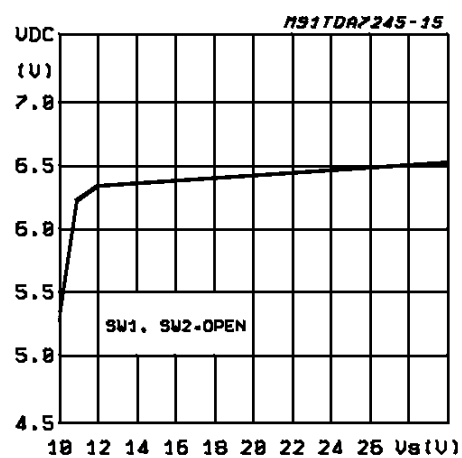

Figure 16: I_{pin4} (muting) vs. Supply Voltage

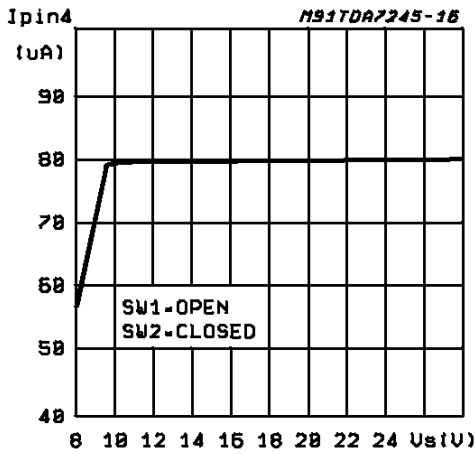

Figure 17: I_{pin5} (St-By) vs. Supply Voltage

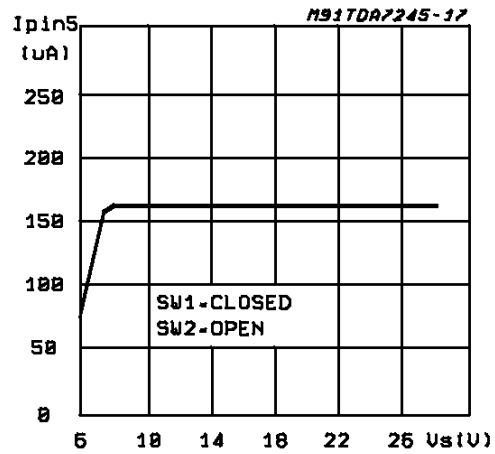

Figure 18: Quiescent Current (St-By) vs. Supply Voltage

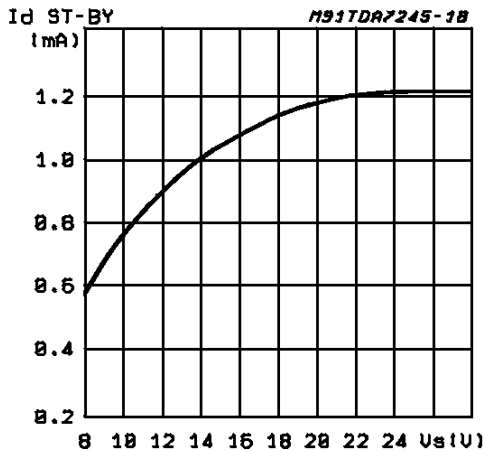

Figure 19: Output Attenuation vs. V_{pin5}

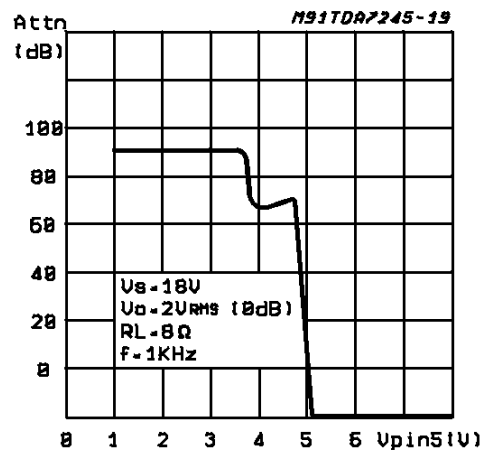
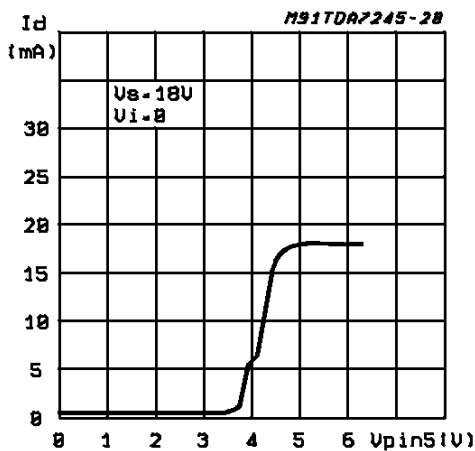

Figure 20: Quiescent Current vs. V_{pin5}



MUTING / STAND-BY

The muting function allows to inhibit the output signal through an external control signal.

It can be used in many cases, when a temporary inhibition of the output signal is requested, for example:

- in switch-on condition, to avoid preamplifier power-on transients
- during switching at the input stages
- during the receiver tuning.

The stand-by function is very useful and permits a complete turn ON/OFF of the device through a low power signal, which can be provided by a μP .

THERMAL SHUTDOWN

The presence of a thermal limiting circuit offers the following advantages:

- 1) An overload on the output (even if it is permanent), or an above limit ambient temperature can be easily tolerated since the T_j cannot be higher than 150°C .
- 2) The heatsink can have a smaller factor of safety compared with that of a conventional circuit. There is no possibility of device damage due to high junction temperature.

If for any reason, the junction temperature increase up to 150°C , the thermal shutdown simply reduces the power dissipation and the current consumption.

The maximum allowable power dissipation depends upon the junction-ambient thermal resistance. Fig. 21 shows this dissippable power as a function of ambient temperature for different thermal resistance.

Figure 21: Maximum Allowable Power Dissipation vs. Ambient Temperature

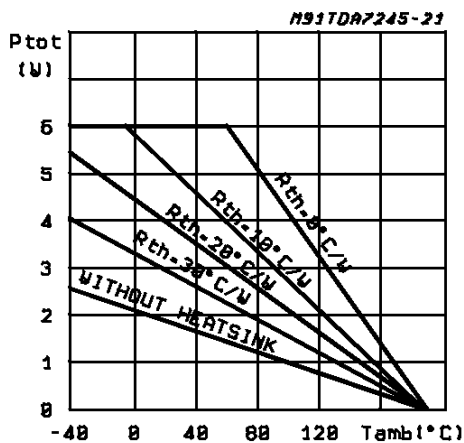

MOUNTING INSTRUCTIONS

The TDA7245 is assembled in the POWERDIP, in which 9 pins (from 10 to 18) are attached to the frame and remove the heat produced by the chip. Figure 22 shows a PC Board copper area used as a Heatsink ($l = 65\text{mm}$). The Thermal Resistance Junction-Ambient is 35°C .

Figure 22: Example of Heatsink using PC Board Copper ($l = 65\text{mm}$)

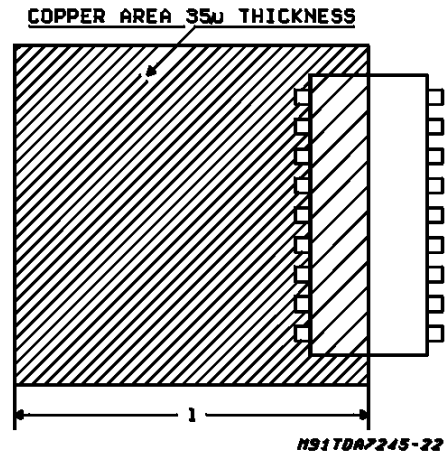

POWERDIP 18 (9+9) PACKAGE MECHANICAL DATA

DIM.	mm			inch		
	MIN.	TYP.	MAX.	MIN.	TYP.	MAX.
a1	0.51			0.020		
B	0.85		1.40	0.033		0.055
b		0.50			0.020	
b1	0.38		0.50	0.015		0.020
D			24.80			0.976
E		8.80			0.346	
e		2.54			0.100	
e3		20.32			0.800	
F			7.10			0.280
I			5.10			0.201
L		3.30			0.130	
Z			2.54			0.100

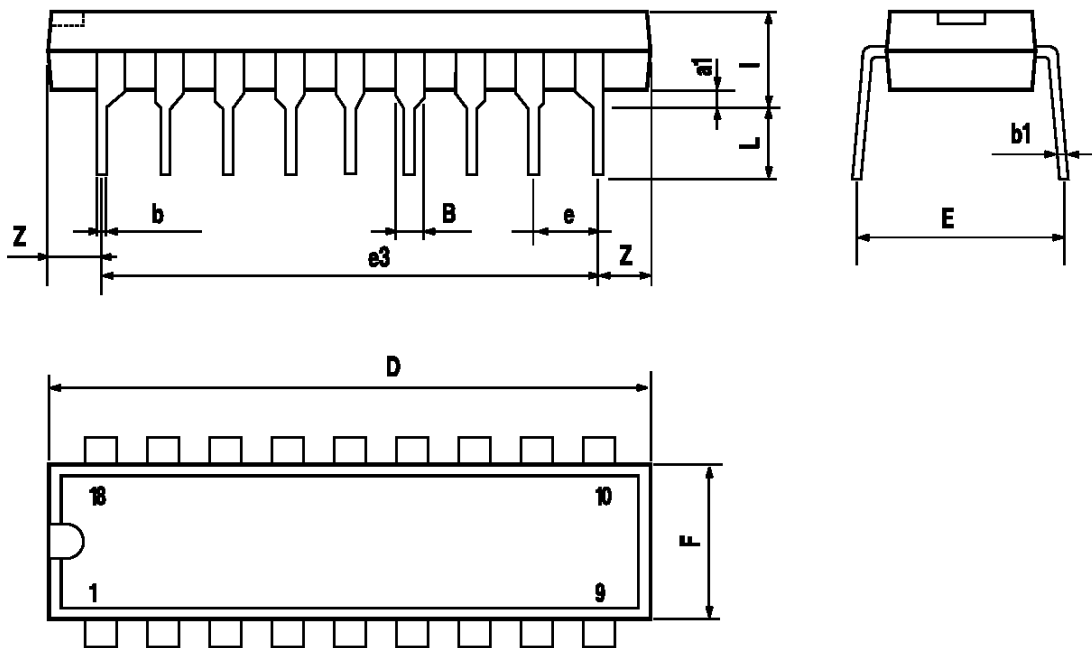

Information furnished is believed to be accurate and reliable. However, SGS-THOMSON Microelectronics assumes no responsibility for the consequences of use of such information nor for any infringement of patents or other rights of third parties which may result from its use. No license is granted by implication or otherwise under any patent or patent rights of SGS-THOMSON Microelectronics. Specification mentioned in this publication are subject to change without notice. This publication supersedes and replaces all information previously supplied. SGS-THOMSON Microelectronics products are not authorized for use as critical components in life support devices or systems without express written approval of SGS-THOMSON Microelectronics.

© 1996 SGS-THOMSON Microelectronics – Printed in Italy – All Rights Reserved

SGS-THOMSON Microelectronics GROUP OF COMPANIES

Australia - Brazil - Canada - China - France - Germany - Hong Kong - Italy - Japan - Korea - Malaysia - Malta - Morocco - The Netherlands - Singapore - Spain - Sweden - Switzerland - Taiwan - Thailand - United Kingdom - U.S.A.