

Preliminary Data Sheet

Features

- For CDMA handset IF applications
- Usable bandwidth of 1.26 MHz
- Low loss
- High attenuation at tones
- Single-ended or balanced operation
- Ceramic Surface Mount Package (SMP)
- Small size

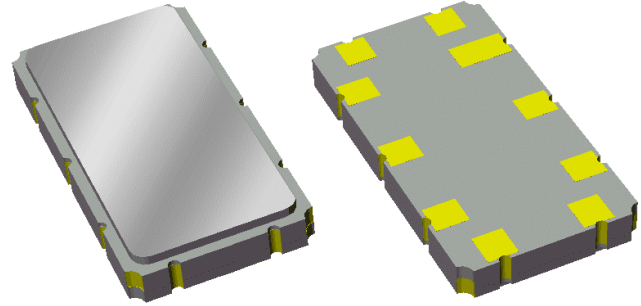

Package

Surface Mount 9.10 x 4.80 x 1.24 mm

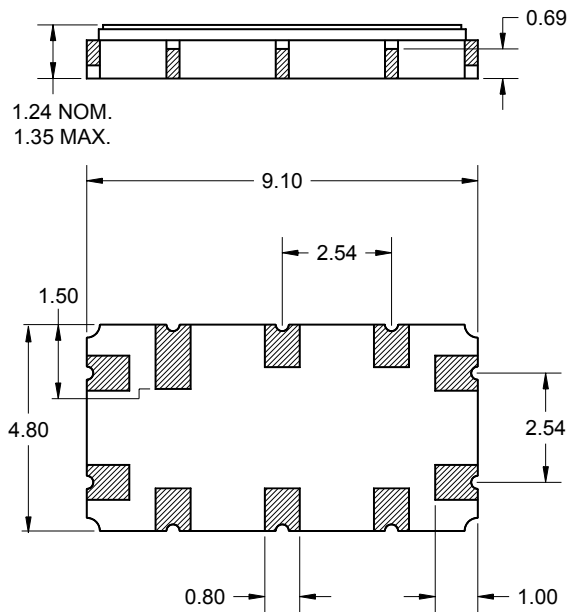

Pin Configuration

Bottom View

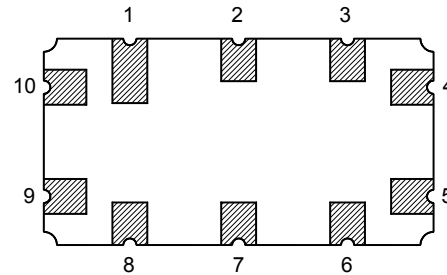

Pin No.	Description
4	Output
5	Output return
9	Input
10	Input return
1,2,3	Case ground
6,7,8	Case ground

Dimensions shown are nominal in millimeters
All tolerances are ± 0.15 mm except overall
length and width ± 0.10 mm

Body: Al_2O_3 ceramic
Lid: Kovar, Ni plated
Terminations: Au plating 0.5 - 1.0 μ m,
over a 2 - 6 μ m Ni plating

Preliminary Data Sheet

Electrical Specifications ⁽¹⁾

Operating Temperature Range: ⁽²⁾ -30 to +85 °C

Parameter ⁽³⁾	Minimum	Typical	Maximum	Unit
Center Frequency, f_0	-	183.6	-	MHz
Insertion Loss at 183.6 MHz				
Excluding losses due to matching	-	4.8	6.4	dB
Including losses in matching test circuit shown below	-	9.5	11.1	dB
Lower 5 dB Point	-	182.886	182.970	MHz
Upper 5 dB Point	184.230	184.320	-	MHz
Amplitude Variation 183.3 - 183.9 MHz	-	0.70	1.25	dB p-p
RMS Phase Variation 182.97 - 184.23 MHz	-	2.4	3.2	deg RMS
Attenuation ⁽⁴⁾				
$f_0 \pm 0.90$ MHz	33	45	-	dB
$f_0 \pm 1.25$ MHz	33	38	-	dB
$f_0 \pm 1.70$ MHz	33	40	-	dB
$f_0 \pm 2.05$ MHz	33	38	-	dB
Rejection ⁽⁴⁾				
10.00 - 171.60 MHz	45	50	-	dB
171.60 - 174.60 MHz	38	42	-	dB
174.60 - 182.70 MHz	33	36	-	dB
184.50 - 192.60 MHz	33	36	-	dB
192.60 - 195.60 MHz	38	42	-	dB
195.60 - 367.20 MHz	45	50	-	dB
Optimal Source Impedance ⁽⁵⁾	-	1160 Ω 69nH	-	-
Optimal Load Impedance ⁽⁵⁾	-	3395 Ω 121nH	-	-

Notes:

1. All specifications are based on the test circuit shown below
2. In production, devices will be tested at room temperature to a guardbanded specification to ensure electrical compliance over temperature
3. Electrical margin has been built into the design to account for the variations due to manufacturing tolerances
4. Relative to insertion loss at 183.6 MHz
5. This is the complex conjugate of the unmatched filter's impedance resulting in maximum power transfer

Test Circuit:

Actual matching values may vary due to PCB layout and parasitics

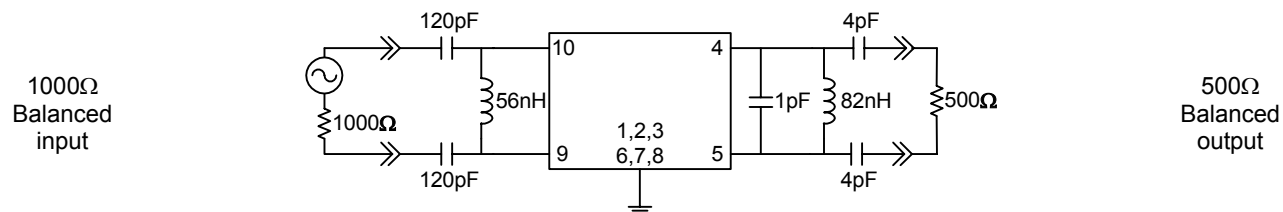

Preliminary Data Sheet

Typical Performance (at +25°C)

Frequency Response

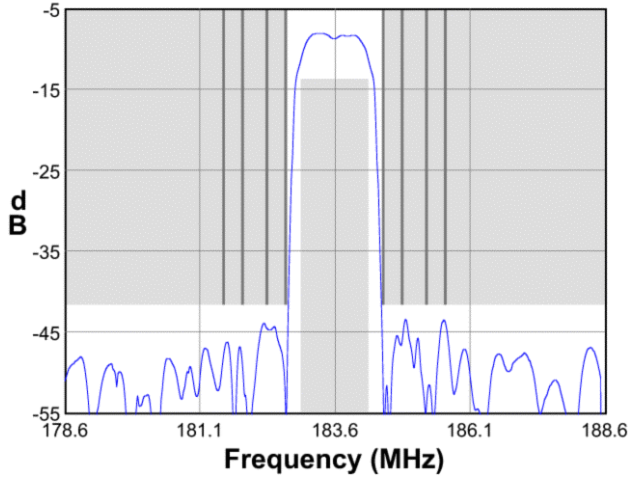

Passband Response

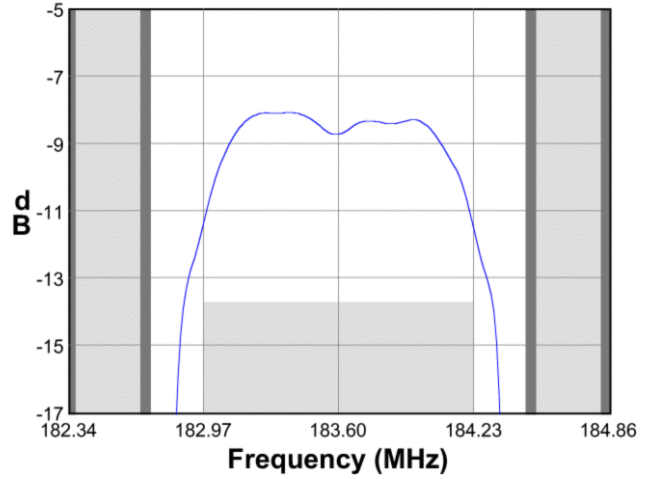

Wideband Response

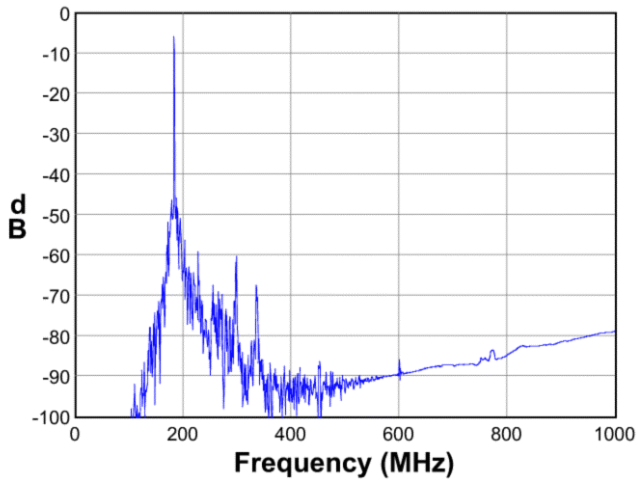

Phase Linearity

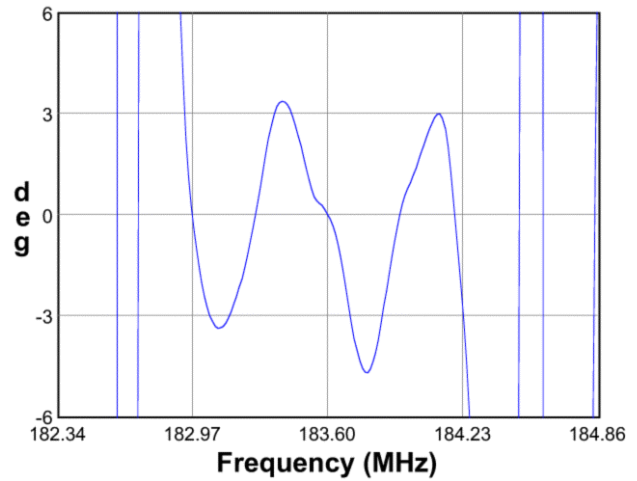

Input Smith Chart

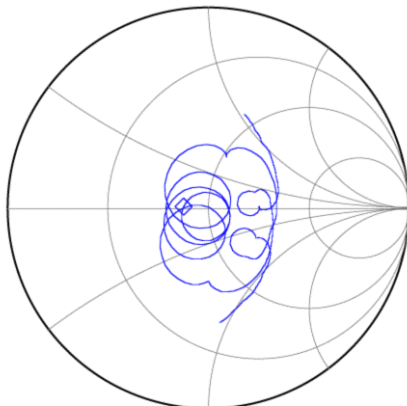

Output Smith Chart

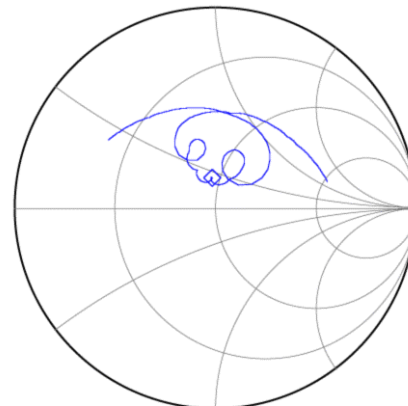

Preliminary Data Sheet

Matching Schematics

Actual matching values may vary due to PCB layout and parasitics

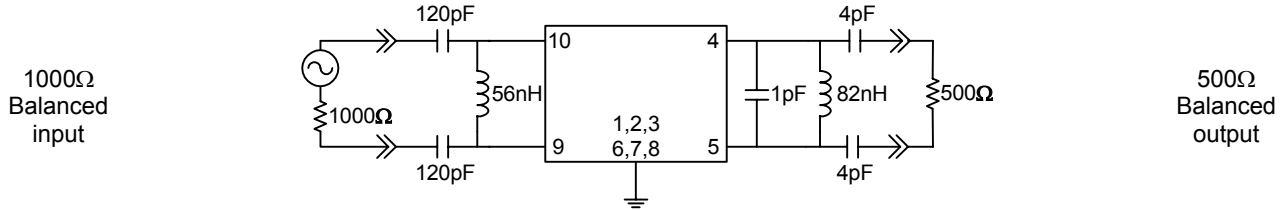

Marking

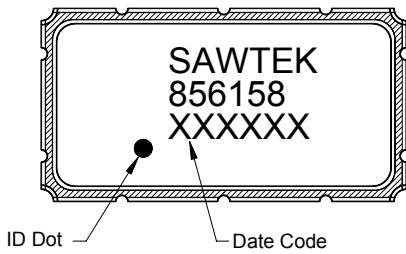

The date code consists of: JJJ = Julian day,
Y = last digit of year, M = manufacturing site code

PCB Footprint

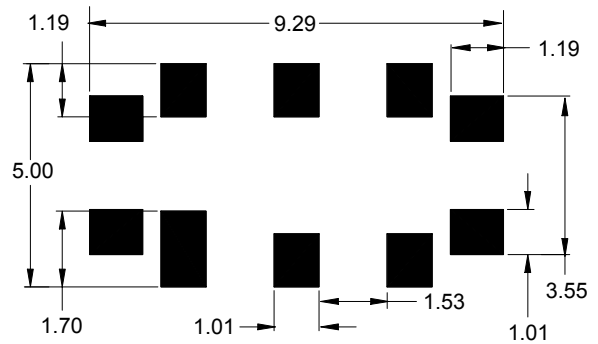

This footprint represents a recommendation only
Dimensions shown are nominal in millimeters

Tape and Reel

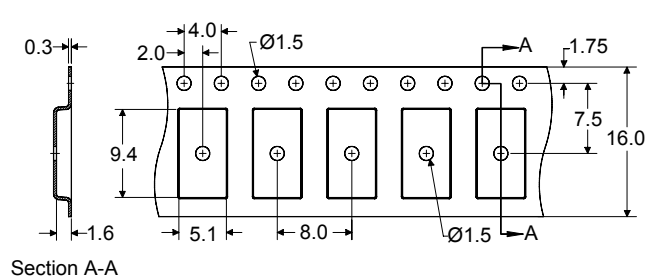
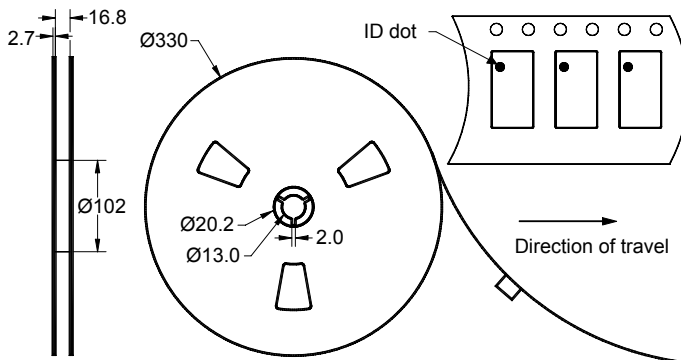

Dimensions shown are nominal in millimeters
Packaging quantity: 4000 units/reel

Preliminary Data Sheet

Maximum Ratings

Parameter	Symbol	Minimum	Maximum	Unit
Operating Temperature Range	T	-30	+85	°C
Storage Temperature Range	T _{stg}	-40	+85	°C

Warnings

- Electrostatic Sensitive Device (ESD) 
- Avoid ultrasonic exposure

Links to Additional Technical Information

[PCB Layout Tips](#)

[Qualification Flowchart](#)

[Soldering Profile](#)

[S-Parameters](#)

[Other Technical Information](#)

Sawtek's liability is limited only to the Surface Acoustic Wave (SAW) component(s) described in this data sheet. Sawtek does not accept any liability for applications, processes, circuits or assemblies which are implemented using any Sawtek component described in this data sheet.

Contact Information



PO Box 609501
 Orlando, FL 32860-9501
 USA

Phone: +1 (407) 886-8860
 Fax: +1 (407) 886-7061
 Email: custservice@sawtek.com
 Web: www.sawtek.com

Or contact one of our worldwide network of [sales offices](#), [representatives](#) or [distributors](#)