

LM2623

General Purpose, Gated Oscillator Based, DC/DC Boost Converter

General Description

The LM2623 is a high efficiency, general purpose, step-up DC-DC switching regulator for battery-powered and low input voltage systems. It accepts an input voltage between .8 and 14 volts and converts it into a regulated output voltage between 1.24 and 14 volts. Efficiencies up to 90% are achievable with the LM2623.

In order to adapt to a number of applications, the LM2623 allows the designer to vary the output voltage, the operating frequency (300kHz to 2 MHz) and duty cycle (17% to 90%) to optimize the part's performance. The selected values can be fixed or can vary with battery voltage or input to output voltage ratio. The LM2623 uses a very simple, on/off regulation mode to produce good efficiency and stable operation over a wide operating range. It normally regulates by skipping switching cycles when it reaches the regulation limit (Pulse Frequency Modulation).

Note: Please read the "Non-Linear Effect" and "Choosing The Correct C3 Capacitor" sub-sections of the Design Procedure section of this data sheet, so that any challenges with designing with this part can be taken into account before a board design/layout is finalized.

For Alternative Solutions, See Also: LM2700, LM2622, LM2731, LM2733, and LM2621.

Features

- Good Efficiency Over a Very Wide Load Range
- Very Low Output Voltage Ripple
- Small, Mini-SO-8 Package (Half the Footprint of Standard 8 pin SO Package)
- 1.09 mm Package Height
- Up to 2 MHz Switching Frequency
- .8V to 14V Operating Voltage
- 1.1V Start-up Voltage
- 1.24V - 14V Adjustable Output Voltage
- Up to 2A Load Current at low Output Voltages
- 0.17Ω Internal MOSFET
- Up to 90% Regulator Efficiency
- 80 μA Typical Operating Current (into V_{DD} pin of supply)
- <2.5μA Guaranteed Supply Current In Shutdown
- 4mm x 4mm Thermally Enhanced LLP Package Option

Applications

- Cameras, Pagers and Cell Phones
- PDAs, Palmtop Computers, GPS devices
- White LED Drive, TFT or Scanned LCDs
- Flash Memory Programming
- Hand-Held Instruments
- 1, 2, 3 or 4 Cell Alkaline Systems
- 1, 2 or 3 Cell Lithium-ion Systems

Typical Application Circuit

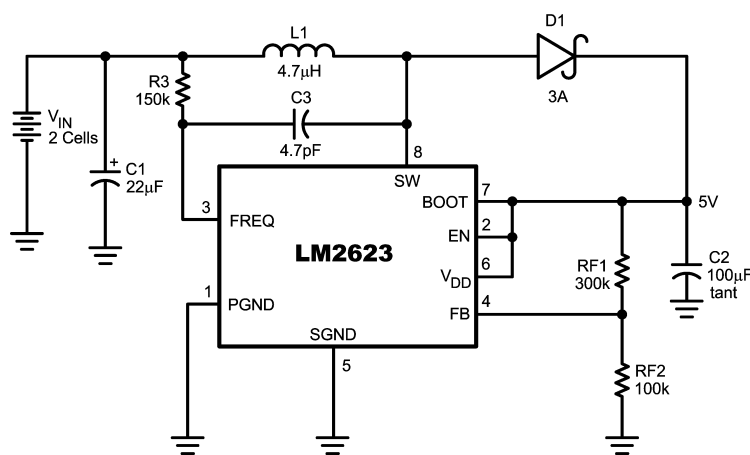

20038801

Connection Diagram

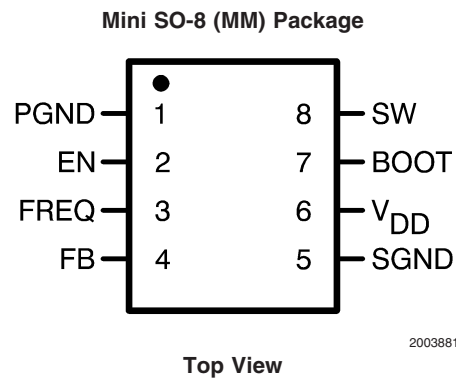
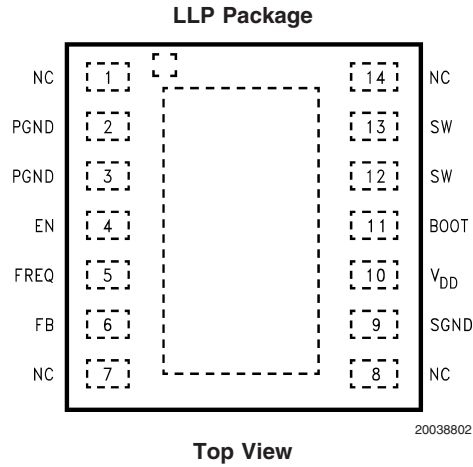

Ordering Information

Order Number	Package Type	NSC Package Drawing	Package Marking	Supplied As
LM2623MMX	Mini SO-8	MUA08A	S46B	3500 Units on Tape and Reel
LM2623AMMX	Mini SO-8	MUA08A	S46A	3500 Units on Tape and Reel
LM2623AMM	Mini SO-8	MUA08A	S46A	1000 Units on Tape and Reel
LM2623MM	Mini SO-8	MUA08A	S46B	1000 Units on Tape and Reel
LM2623LDX	LLP-14	LDA14A	2623AB	4500 Units on Tape and Reel
LM2623ALDX	LLP-14	LDA14A	2623A	4500 Units on Tape and Reel
LM2623LD	LLP-14	LDA14A	2623AB	1000 Units on Tape and Reel
LM2623ALD	LLP-14	LDA14A	2623A	1000 Units on Tape and Reel

Pin Description

LLP-14 Pin	MSOP-8 Pin	Name	Function
1		NC	No Connect
2, 3	1	PGND	Power Ground (LLP Pins 2 & 3 must be shorted together).
4	2	EN	Active-Low Shutdown Input
5	3	FREQ	Frequency Adjust. An external resistor connected between this pin and a voltage source sets the switching frequency of the LM2623.
6	4	FB	Output Voltage Feedback
7		NC	No Connect
8		NC	No connect
9	5	SGND	Signal Ground
10	6	V _{DD}	Power Supply for Internal Circuitry
11	7	BOOT	Bootstrap Supply for the Gate Drive of Internal MOSFET Power Switch
12, 13	8	SW	Drain of the Internal MOSFET Power Switch. (LLP Pins 12 & 13 must be shorted together).
14		NC	No Connect
DAP		DAP	To be soldered to board for enhanced thermal dissipation. To be electrically isolated/floating.

Absolute Maximum Ratings (Note 1)

ESD Rating (Note 3)

2kV

If Military/Aerospace specified devices are required, please contact the National Semiconductor Sales Office/Distributors for availability and specifications.

SW Pin Voltage	-0.5 V to 14.5V
BOOT, V _{DD} , EN and FB Pins	-0.5V to 10V
FREQ Pin	100μA
T _{Jmax} (Note 2)	150°C
Storage Temperature Range	-65°C to +150°C
Lead Temp. (Soldering, 5 sec)	260°C
Power Dissipation (T _A =25°C) (Note 2)	500mW

Operating Conditions (Note 1)

V _{DD} Pin	3V to 5V
FB, EN Pins	0 to V _{DD}
BOOT Pin	0 to 10V
Ambient Temperature (T _A)	-40°C to +85°C

Electrical Characteristics

Limits in standard typeface are for T_J = 25°C, and limits in **boldface** type apply over the full operating temperature range of -40°C to +85°C. Unless otherwise specified: V_{DD} = V_{OUT} = 3.3V.

Symbol	Parameter	Condition	Typ	Min	Max	Units
V _{DD_ST}	Start-Up Supply Voltage 25°C	I _{LOAD} = 0mA (Note 4)			1.1	V
V _{IN_OP}	Minimum Operating Supply Voltage (once started)	I _{LOAD} = 0mA	0.65		.8	V
V _{FB}	FB Pin Voltage		1.24	1.2028	1.2772	V
V _{OUT_MAX}	Maximum Output Voltage		14			V
η	Efficiency	V _{IN} = 3.6V; V _{OUT} = 5V; I _{LOAD} = 500mA	87			%
		V _{IN} = 2.5V; V _{OUT} = 3.3V; I _{LOAD} = 200mA	87			
D	Switch Duty Cycle		17			%
I _{DD}	Operating Quiescent Current (Note 5)	FB Pin > 1.3V; EN Pin at V _{DD}	80		110	μA
I _{SD}	Shutdown Quiescent Current (Note 6)	V _{DD} , BOOT and SW Pins at 5.0V; EN Pin <200mV	0.01		2.5	μA
I _{CL}	Switch Peak Current Limit	LM2623A	2.85	2.2		A
I _C	Switch Peak Current Limit	LM2623		1.2		A
R _{DS_ON}	MOSFET Switch On Resistance		0.17		0.26	Ω
θ _{JA}	Thermal Resistance	MM Package, Junction to Ambient(Note 2)	240			°C/W
θ _{JA}	Thermal Resistance	LLP Package, Junction to Ambient(Notes 2, 8)	40			°C/W
θ _{JA}	Thermal Resistance	LLP Package, Junction to Ambient(Notes 2, 9)	56			°C/W
Enable Section						
V _{EN_LO}	EN Pin Voltage Low (Note 7)				0.15V_{DD}	V
V _{EN_HI}	EN Pin Voltage High (Note 7)			0.7V_{DD}		V

Note 1: Absolute maximum ratings indicate limits beyond which damage to the device may occur. Electrical specifications do not apply when operating the device outside of its rated operating conditions.

Note 2: The maximum power dissipation must be derated at elevated temperatures and is dictated by T_{Jmax} (maximum junction temperature), θ_{JA} (junction to ambient thermal resistance), and T_A (ambient temperature). The maximum allowable power dissipation at any temperature is P_{dmax} = (T_{Jmax} - T_A) / θ_{JA} or the number given in the Absolute Maximum Ratings, whichever is lower.

Note 3: The human body model is a 100 pF capacitor discharged through a 1.5 kΩ resistor into each pin. For Pin 8 (SW) the ESD rating is 1.0 kV.

Note 4: V_{DD} tied to Boot and EN pins. Frequency pin tied to V_{DD} through 121K resistor. V_{DD_ST} = V_{DD} when start-up occurs. V_{IN} is V_{DD} + D1 voltage (usually 10-50 mV at start-up)

Note 5: This is the current into the V_{DD} pin.

Note 6: This is the total current into pins V_{DD}, BOOT, SW and FREQ.

Note 7: When the EN pin is below V_{EN_LO}, the regulator is shut down; when it is above V_{EN_HI}, the regulator is operating.

Electrical Characteristics (Continued)

Note 8: Junction to ambient thermal resistance (θ_{JA}) is taken from a thermal modeling result, performed under the conditions and guidelines set forth in the JEDEC standard JESD51-17. The test board is a 4 layer FR-4 board measuring 102mm x 76mm x 1.6mm with a 3 x 2 array of thermal vias. The ground plane on the board is 50mm x 50 mm. Thickness of copper layers are 36mm/18mm/18mm/36mm (1.5oz/10z/1oz/1.5oz). Ambient temperature in simulation is 22°C, still air. Power dissipation is 1W. (The DAP is soldered.) For more information on LLP thermal topics, as well as LLP mounting and soldering specifications please refer to **Application Note 1187: Leadless Leadframe Package (LLP)**.

Note 9: Exposed DAP soldered to an exposed 1sq. inch area of 1 oz. copper. Thermal resistance can be decreased by using more copper area to dissipate heat.

Typical Performance Characteristics

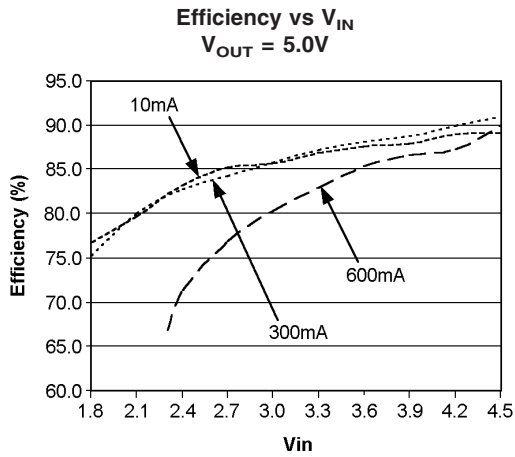

20038829

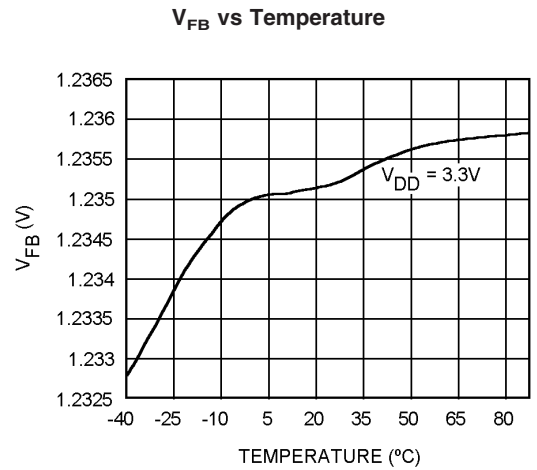

20038831

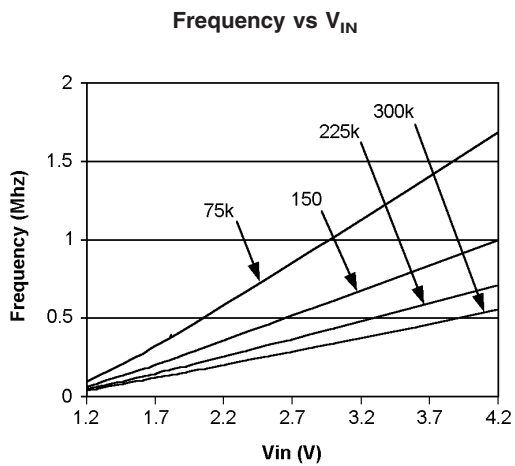

20038828

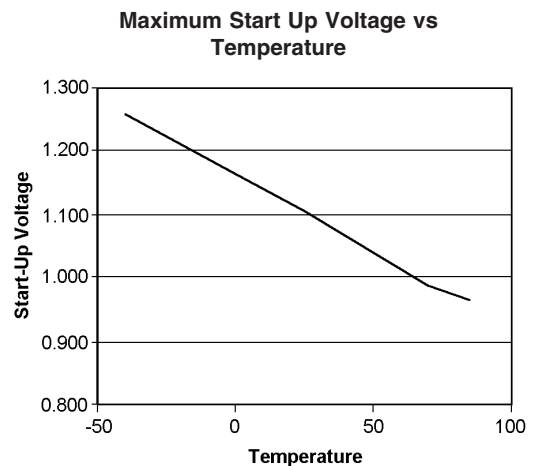

20038826

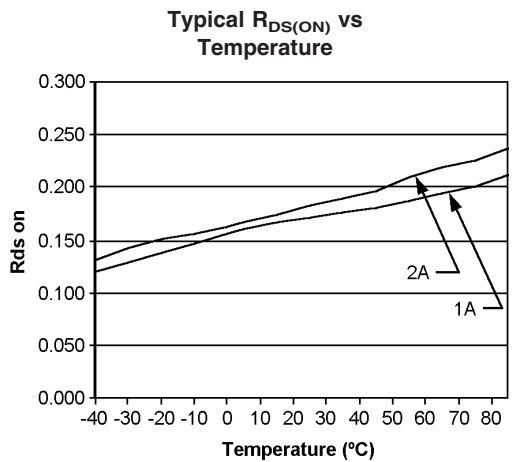

20038825

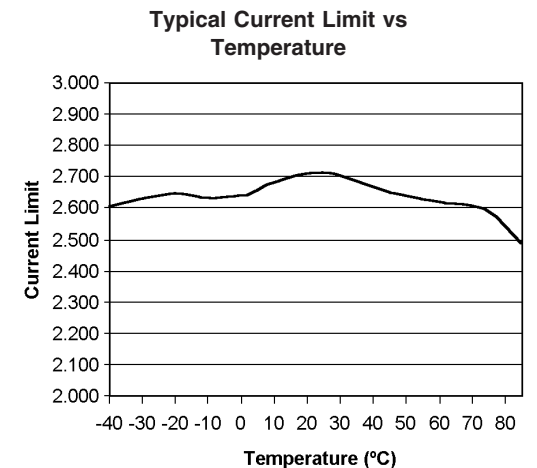

20038827

Detailed Description

OPERATING PRINCIPLE

The LM2623 is designed to provide step-up DC-DC voltage regulation in battery-powered and low-input voltage systems. It combines a step-up switching regulator, N-channel power MOSFET, built-in current limit, thermal limit, and voltage reference in a single 8-pin MSOP package *Figure 1*. The switching DC-DC regulator boosts an input voltage between .8V and 14V to a regulated output voltage between 1.24V and 14V. The LM2623 starts from a low 1.1V input and remains operational down to below .8V.

This device is optimized for use in cellular phones and other applications requiring a small size, low profile, as well as low quiescent current for maximum battery life during stand-by and shutdown. A high-efficiency gated-oscillator topology offers an output of up to 2A at low output voltages.

Additional features include a built-in peak switch current limit, and thermal protection circuitry.

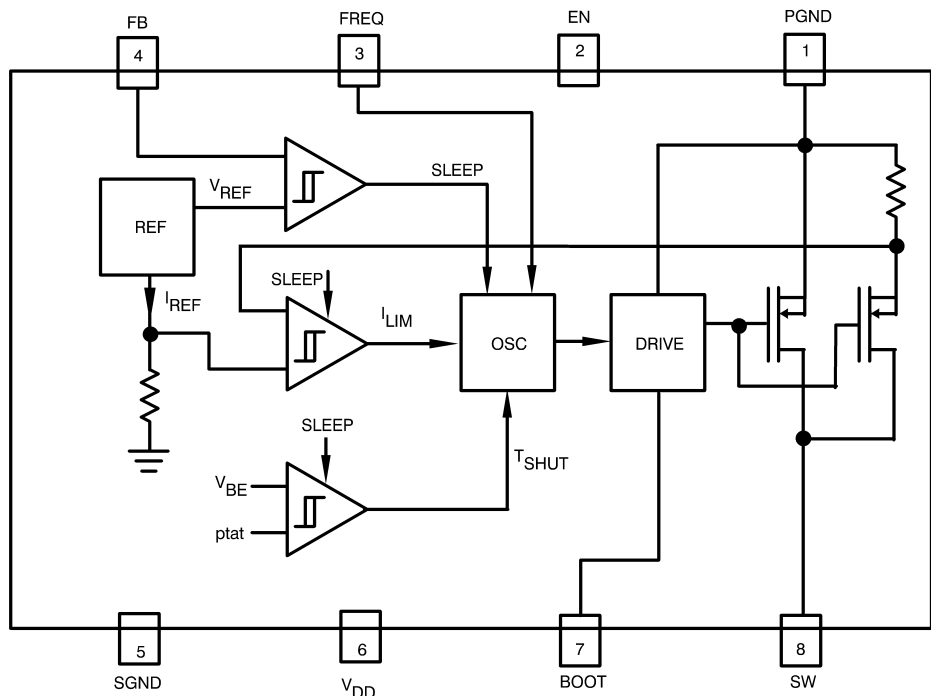

20038814

FIGURE 1. Functional Diagram

GATED OSCILLATOR CONTROL SCHEME

The on/off regulation mode of the LM2623, along with its ultra-low quiescent current, results in good efficiency over a very wide load range. The internal oscillator frequency can be programmed using an external resistor to be constant or vary with the battery voltage. Adding a capacitor to program the frequency allows the designer to adjust the duty cycle and optimize it for the application. Adding a resistor in addi-

tion to the capacitor allows the duty cycle to dynamically compensate for changes to the input/output voltage ratio. We call this a Ratio Adaptive Gated Oscillator circuit. See the Application Notes for sample application circuits. Using the correct RC components to adjust the oscillator allows the part to run with low ripple and high efficiency over a wide range of loads and input/output voltages.

Detailed Description (Continued)

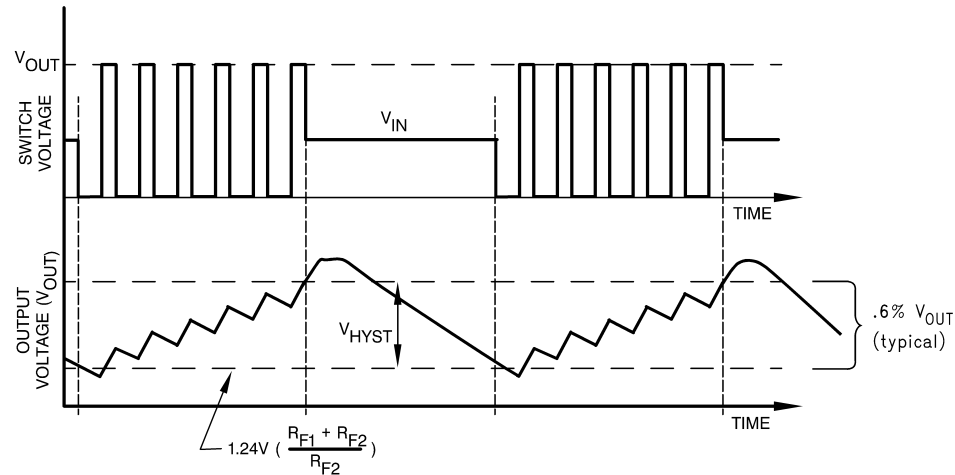

20038815

FIGURE 2. Typical Step-Up Regulator Waveforms

PULSE FREQUENCY MODULATION (PFM)

Pulse Frequency Modulation is typically accomplished by switching continuously until the voltage limit is reached and skipping cycles after that to just maintain it. This results in a somewhat hysteretic mode of operation. The coil stores more energy each cycle as the current ramps up to high levels. When the voltage limit is reached, the system usually overshoots to a higher voltage than required, due to the stored energy in the coil (see figure 2). The system will also undershoot somewhat when it starts switching again because it has depleted all the stored energy in the coil and needs to store more energy to reach equilibrium with the load. Larger output capacitors and smaller inductors reduce the ripple in these situations. The frequency being filtered, however, is not the basic switching frequency. It is a lower frequency determined by the load, the input/output voltage and the circuit parameters. This mode of operation is useful in situations where the load variation is significant. Power managed computer systems, for instance, may vary from zero to full load while the system is on and this is usually the preferred regulation mode for such systems.

CYCLE TO CYCLE PFM

When the load doesn't vary over a wide range (like zero to full load), ratio adaptive circuit techniques can be used to achieve cycle to cycle PFM regulation and lower ripple (or smaller output capacitors). The key to success here is matching the duty cycle of the circuit closely to what is required by the input to output voltage ratio. This ratio then needs to be dynamically adjusted for input voltage changes (usually caused by batteries running down). The chosen ratio should allow most of the energy in each switching cycle to be delivered to the load and only a small amount to be stored. When the regulation limit is reached, the overshoot will be small and the system will settle at an equilibrium point where it adjusts the off time in each switching cycle to meet the current requirements of the load. The off time adjustment is done by exceeding the regulation limit during each switching cycle and waiting until the voltage drops below the limit again to start the next switching cycle. The current in the coil

never goes to zero like it frequently does in the hysteretic operating mode of circuits with wide load variations or duty cycles that aren't matched to the input/output voltage ratio. Optimizing the duty cycle for a given set of input/output voltages conditions can be done by using the circuit values in the Application Notes.

LOW VOLTAGE START-UP

The LM2623 can start-up from voltages as low as 1.1 volts. On start-up, the control circuitry switches the N-channel MOSFET continuously until the output reaches 3 volts. After this output voltage is reached, the normal step-up regulator feedback and gated oscillator control scheme take over. Once the device is in regulation, it can operate down to below .8V input, since the internal power for the IC can be boot-strapped from the output using the V_{DD} pin.

SHUT DOWN

The LM2623 features a shutdown mode that reduces the quiescent current to less than a guaranteed 2.5uA over temperature. This extends the life of the battery in battery powered applications. During shutdown, all feedback and control circuitry is turned off. The regulator's output voltage drops to one diode drop below the input voltage. Entry into the shutdown mode is controlled by the active-low logic input pin EN (pinh- 2). When the logic input to this pin is pulled below .15V_{DD}, the device goes into shutdown mode. The logic input to this pin should be above .7V_{DD} for the device to work in normal stepup mode.

INTERNAL CURRENT LIMIT AND THERMAL PROTECTION

An internal cycle-by-cycle current limit serves as a protection feature. This is set high enough (2.85A typical, approximately 4A maximum) so as not to come into effect during normal operating conditions. An internal thermal protection circuit disables the MOSFET power switch when the junction temperature (T_J) exceeds about 160°C. The switch is re-enabled when T_J drops below approximately 135°C.

Design Procedure

NON-LINEAR EFFECT

The LM2623 is very similar to the LM2621. The LM2623 is based on the LM2621, except for the fact that the LM2623 takes advantage of a non-linear effect that allows for the duty cycle to be programmable. The C3 capacitor is used to dump charge on the FREQ pin in order to manipulate the duty cycle of the internal oscillator. The part is being tricked to behave in a certain manner, in the effort to make this Pulse Frequency Modulated (PFM) boost switching regulator behave as a Pulse Width Modulated (PWM) boost switching regulator.

CHOOSING THE CORRECT C3 CAPACITOR

The C3 capacitor allows for the duty cycle of the internal oscillator to be programmable. Choosing the correct C3 capacitor to get the appropriate duty cycle for a particular application circuit is a trial and error process. The non-linear effect that C3 produces is dependent on the input voltage and output voltage values. The correct C3 capacitor for particular input and output voltage values cannot be calculated. Choosing the correct C3 capacitance is best done by trial and error, in conjunction with the checking of the inductor peak current to make sure your not too close to the current limit of the device. As the C3 capacitor value increases, so does the duty cycle. And conversely as the C3 capacitor value decreases, the duty cycle decreases. An incorrect choice of the C3 capacitor can result in the part prematurely tripping the current limit and/or double pulsing, which could lead to the output voltage not being stable.

SETTING THE OUTPUT VOLTAGE

The output voltage of the step-up regulator can be set by connecting a feedback resistive divider made of R_{F1} and R_{F2} . The resistor values are selected as follows:

$$R_{F1} = R_{F2} * [(V_{OUT}/ 1.24) - 1]$$

A value of 50k to 100k is suggested for R_{F2} . Then, R_{F1} can be selected using the above equation.

V_{DD} SUPPLY

The V_{DD} supply must be between 3 to 5 volts for the LM2623. This voltage can be bootstrapped from a much lower input voltage by simply connecting the V_{DD} pin to V_{OUT}. In the event that the V_{DD} supply voltage is not a low ripple voltage source (less than 200 millivolts), it may be advisable to use an RC filter to clean it up. Excessive ripple on V_{DD} may reduce the efficiency.

SETTING THE SWITCHING FREQUENCY

The switching frequency of the oscillator is selected by choosing an external resistor (R3) connected between V_{IN} and the FREQ pin. See the graph titled "Frequency vs V_{IN}" in the Typical Performance Characteristics section of the data sheet for choosing the R3 value to achieve the desired switching frequency. A high switching frequency allows the use of very small surface mount inductors and capacitors and results in a very small solution size. A switching frequency between 300kHz and 2MHz is recommended.

OUTPUT DIODE SELECTION

A Schottky diode should be used for the output diode. The forward current rating of the diode should be higher than the peak input current, and the reverse voltage rating must be higher than the output voltage. Do not use ordinary rectifier diodes, since slow switching speeds and long recovery times cause the efficiency and the load regulation to suffer. *Table 1* shows a list of the diode manufacturers.

LLP PACKAGE DEVICES

The LM2623 is offered in the 14 lead LLP surface mount package to allow for increased power dissipation compared to the MSOP-8. For details of the thermal performance as well as mounting and soldering specifications, refer to **Application Note AN-1187**.

TABLE 1. Suggested Manufacturers List

Inductors	Capacitors	Diodes
Coilcraft Tel: (800) 322-2645 Fax: (708) 639-1469	Sprague/ Vishay Tel: (207) 324-4140 Fax: (207) 324-7223	Motorola Tel: (800) 521-6274 Fax: (602) 244-6609
Coiltronics Tel: (407) 241-7876 Fax: (407) 241-9339	Kemet Tel: (864) 963-6300 Fax: (864) 963-6521	International Rectifier (IR) Tel: (310) 322-3331 Fax: (310) 322-3332
Pulse Engineering Tel: (619) 674-8100 Fax: (619) 674-8262	Nichicon Tel: (847) 843-7500 Fax: (847) 843-2798	General Semiconductor Tel: (516) 847-3222 Fax: (516) 847-3150

Physical Dimensions inches (millimeters) unless otherwise noted

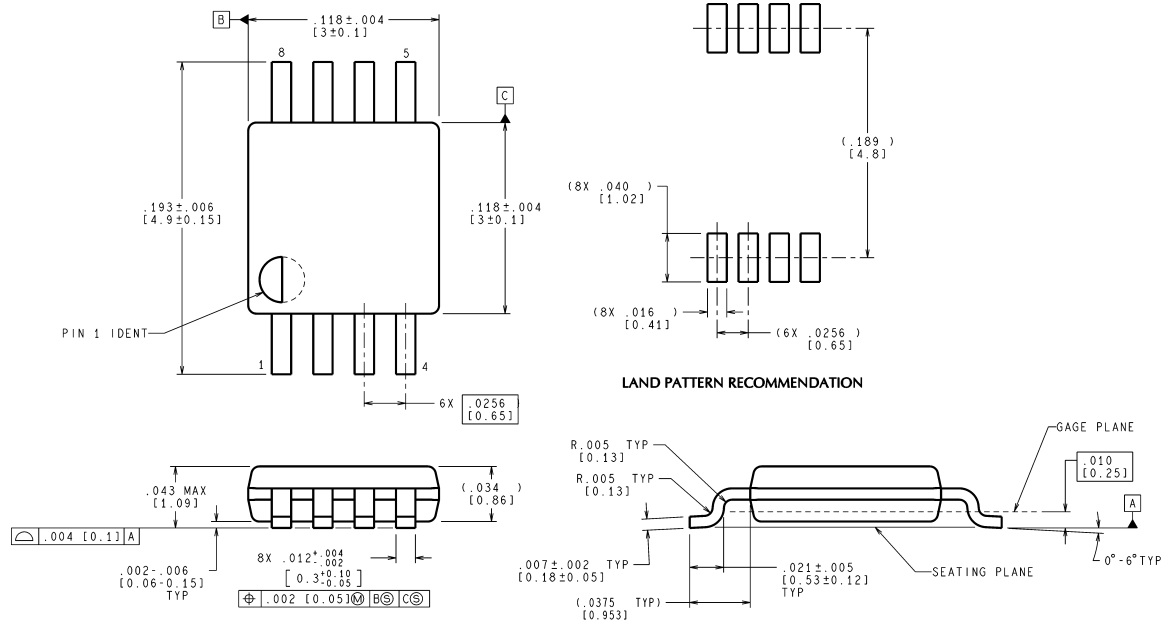

CONTROLLING DIMENSION IS INCH
VALUES IN [] ARE MILLIMETERS

MUA08A (Rev E)

**8-Lead Mini SO-8 (MM)
NS Package Number MUA08A**

For Order Numbers, refer to the table in the "Ordering Information" section of this document.

Physical Dimensions inches (millimeters) unless otherwise noted (Continued)

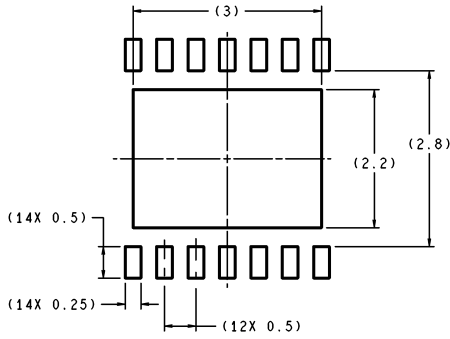

RECOMMENDED LAND PATTERN
1:1 RATION WITH PKG SOLDER PADS

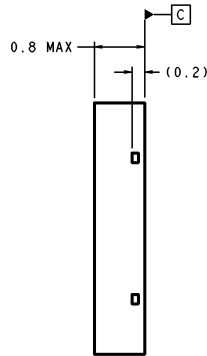
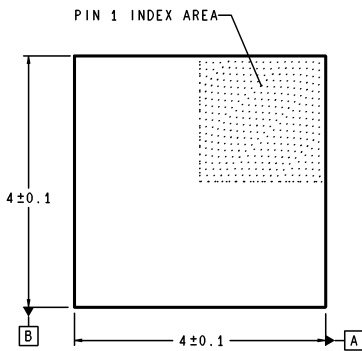

DIMENSIONS ARE IN MILLIMETERS

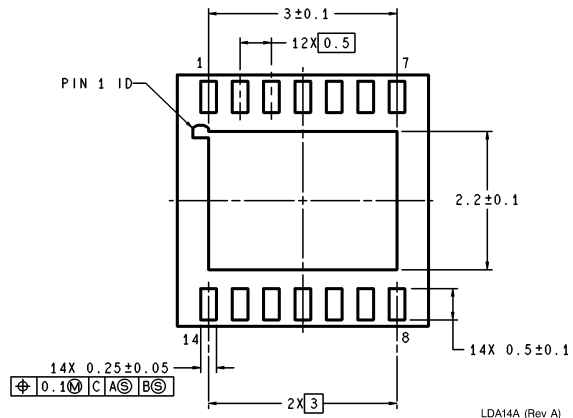

LDA14A (Rev A)

NS Package Number LDA14A

For Order Numbers, refer to the table in the "Ordering Information" section of this document.

National does not assume any responsibility for use of any circuitry described, no circuit patent licenses are implied and National reserves the right at any time without notice to change said circuitry and specifications.

For the most current product information visit us at www.national.com.

LIFE SUPPORT POLICY

NATIONAL'S PRODUCTS ARE NOT AUTHORIZED FOR USE AS CRITICAL COMPONENTS IN LIFE SUPPORT DEVICES OR SYSTEMS WITHOUT THE EXPRESS WRITTEN APPROVAL OF THE PRESIDENT AND GENERAL COUNSEL OF NATIONAL SEMICONDUCTOR CORPORATION. As used herein:

1. Life support devices or systems are devices or systems which, (a) are intended for surgical implant into the body, or (b) support or sustain life, and whose failure to perform when properly used in accordance with instructions for use provided in the labeling, can be reasonably expected to result in a significant injury to the user.
2. A critical component is any component of a life support device or system whose failure to perform can be reasonably expected to cause the failure of the life support device or system, or to affect its safety or effectiveness.

BANNED SUBSTANCE COMPLIANCE

National Semiconductor manufactures products and uses packing materials that meet the provisions of the Customer Products Stewardship Specification (CSP-9-111C2) and the Banned Substances and Materials of Interest Specification (CSP-9-111S2) and contain no "Banned Substances" as defined in CSP-9-111S2.

Leadfree products are RoHS compliant.



National Semiconductor
Americas Customer
Support Center
Email: new.feedback@nsc.com
Tel: 1-800-272-9959

National Semiconductor
Europe Customer Support Center
Fax: +49 (0) 180-530 85 86
Email: europe.support@nsc.com
Deutsch Tel: +49 (0) 69 9508 6208
English Tel: +44 (0) 870 24 0 2171
Français Tel: +33 (0) 1 41 91 8790

National Semiconductor
Asia Pacific Customer
Support Center
Email: ap.support@nsc.com

National Semiconductor
Japan Customer Support Center
Fax: 81-3-5639-7507
Email: jpn.feedback@nsc.com
Tel: 81-3-5639-7560

www.national.com