

LMC7111

Tiny CMOS Operational Amplifier with Rail-to-Rail Input and Output

General Description

The LMC7111 is a micropower CMOS operational amplifier available in the space saving SOT 23-5 package. This makes the LMC7111 ideal for space and weight critical designs. The wide common-mode input range makes it easy to design battery monitoring circuits which sense signals above the V^+ supply. The main benefits of the Tiny package are most apparent in small portable electronic devices, such as mobile phones, pagers, and portable computers. The tiny amplifiers can be placed on a board where they are needed, simplifying board layout.

Features

- Tiny 5-Pin SOT23 package saves space
- Very wide common mode input range

- Specified at 2.7V, 5V, and 10V
- Typical supply current 25 μ A at 5V
- 50 kHz gain-bandwidth at 5V
- Similar to popular LMC6462
- Output to within 20 mV of supply rail at 100k load
- Good capacitive load drive

Applications

- Mobile communications
- Portable computing
- Current sensing for battery chargers
- Voltage reference buffering
- Sensor interface
- Stable bias for GaAs RF amps

Connection Diagrams

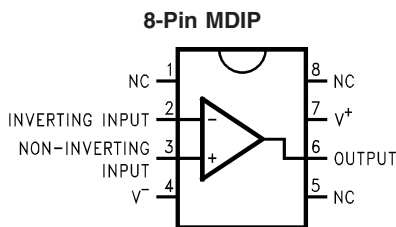

Top View

01235201

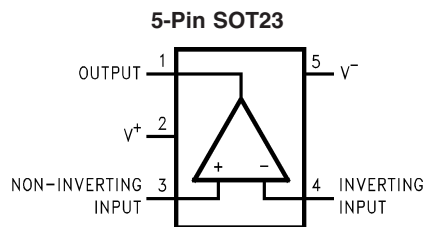

Top View

01235202

Actual Size



01235219

Ordering Information

| Package | Part Number | Package Marking | Transport Media | NSC Drawing |
|-------------|--------------|-----------------|------------------------|-------------|
| 8-Pin MDIP | LMC7111AIN | LMC7111AIN | 40 Units/Rail | N08E |
| | LMC7111BIN | LMC7111BIN | 40 Units/Rail | |
| 5-Pin SOT23 | LMC7111BIM5 | A01B | 1k units Tape and Reel | MF05A |
| | LMC7111BIM5X | | 3k Units Tape and Reel | |

Absolute Maximum Ratings (Note 1)

If Military/Aerospace specified devices are required, please contact the National Semiconductor Sales Office/Distributors for availability and specifications.

| | |
|--------------------------------|------------------------------|
| ESD Tolerance (Note 2) | |
| SOT23 Package | 2000V |
| MDIP Package | 1500V |
| Differential Input Voltage | \pm Supply Voltage |
| Voltage at Input/Output Pin | $(V^+) + 0.3V, (V^-) - 0.3V$ |
| Supply Voltage ($V^+ - V^-$) | 11V |
| Current at Input Pin | ± 5 mA |
| Current at Output Pin (Note 3) | ± 30 mA |
| Current at Power Supply Pin | 30 mA |

| | |
|---------------------------------|-----------------|
| Lead Temp. (Soldering, 10 sec.) | 260°C |
| Storage Temperature Range | -65°C to +150°C |
| Junction Temperature (Note 4) | 150°C |

Operating Ratings (Note 1)

| | |
|--------------------------------------|---|
| Supply Voltage | $2.5V \leq V^+ \leq 11V$ |
| Junction Temperature Range | $-40^\circ\text{C} \leq T_J \leq +85^\circ\text{C}$ |
| LMC7111AI, LMC7111BI | |
| Thermal Resistance (θ_{JA}) | |
| 8-Pin MDIP | 115°C/W |
| 5-Pin SOT23 | 325°C/W |

2.7V DC Electrical Characteristics

Unless otherwise specified, all limits guaranteed for $T_J = 25^\circ\text{C}$, $V^+ = 2.7V$, $V^- = 0V$, $V_{CM} = V_O = V^+/2$ and $R_L > 1$ M Ω . **Bold-face** limits apply at the temperature extremes.

| Symbol | Parameter | Conditions | Typ (Note 5) | LMC7111AI Limit (Note 6) | LMC7111BI Limit (Note 6) | Units |
|------------|--|---|-----------------|--------------------------------|--------------------------------|------------------------------|
| V_{OS} | Input Offset Voltage | $V^+ = 2.7V$ | 0.9 | 3 5 | 7 9 | mV max |
| TCV_{OS} | Input Offset Voltage Average Drift | | 2.0 | | | $\mu\text{V}/^\circ\text{C}$ |
| I_B | Input Bias Current | (Note 9) | 0.1 | 1 20 | 1 20 | pA max |
| I_{OS} | Input Offset Current | (Note 9) | 0.01 | 0.5 10 | 0.5 10 | pA max |
| R_{IN} | Input Resistance | | >10 | | | Tera Ω |
| +PSRR | Positive Power Supply Rejection Ratio | $2.7V \leq V^+ \leq 5.0V$, $V^- = 0V, V_O = 2.5V$ | 60 | 55 50 | 55 50 | dB min |
| -PSRR | Negative Power Supply Rejection Ratio | $-2.7V \leq V^- \leq -5.0V$, $V^+ = 0V, V_O = 2.5V$ | 60 | 55 50 | 55 50 | dB min |
| V_{CM} | Input Common-Mode Voltage Range | $V^+ = 2.7V$ For CMRR ≥ 50 dB | -0.10 | 0.0 0.40 | 0.0 0.40 | V min |
| | | | 2.8 | 2.7 2.25 | 2.7 2.25 | V max |
| C_{IN} | Common-Mode Input Capacitance | | 3 | | | pF |
| V_O | Output Swing | $V^+ = 2.7V$ $R_L = 100$ k Ω | 2.69 | 2.68 2.4 | 2.68 2.4 | V min |
| | | | 0.01 | 0.02 0.08 | 0.02 0.08 | V max |
| | | $V^+ = 2.7V$ $R_L = 10$ k Ω | 2.65 | 2.6 2.4 | 2.6 2.4 | V min |
| | | | 0.03 | 0.1 0.3 | 0.1 0.3 | V max |
| I_{SC} | Output Short Circuit Current | Sourcing, $V_O = 0V$ | 7 | 1 0.7 | 1 0.7 | mA min |
| | | Sinking, $V_O = 2.7V$ | 7 | 1 0.7 | 1 0.7 | mA min |

2.7V DC Electrical Characteristics (Continued)

Unless otherwise specified, all limits guaranteed for $T_J = 25^\circ\text{C}$, $V^+ = 2.7\text{V}$, $V^- = 0\text{V}$, $V_{\text{CM}} = V_O = V^+/2$ and $R_L > 1\text{M}\Omega$. **Bold-face** limits apply at the temperature extremes.

| Symbol | Parameter | Conditions | Typ (Note 5) | LMC7111AI Limit (Note 6) | LMC7111BI Limit (Note 6) | Units |
|------------------|----------------|---|-----------------|--------------------------------|--------------------------------|----------------------|
| A_{VOL} | Voltage Gain | Sourcing | 400 | | | V/mv min |
| | | Sinking | 150 | | | V/mv min |
| I_S | Supply Current | $V^+ = +2.7\text{V}$, $V_O = V^+/2$ | 20 | 45 60 | 50 65 | μA max |

2.7V AC Electrical Characteristics

Unless otherwise specified, all limits guaranteed for $T_J = 25^\circ\text{C}$, $V^+ = 2.7\text{V}$, $V^- = 0\text{V}$, $V_{\text{CM}} = V_O = V^+/2$ and $R_L > 1\text{M}\Omega$. **Bold-face** limits apply at the temperature extremes.

| Symbol | Parameter | Conditions | Typ (Note 5) | LMC7111AI Limit (Note 6) | LMC7111BI Limit (Note 6) | Units |
|--------|------------------------|------------|-----------------|--------------------------------|--------------------------------|------------------|
| SR | Slew Rate | (Note 8) | 0.015 | | | V/ μs |
| GBW | Gain-Bandwidth Product | | 40 | | | kHz |

Note 1: Absolute Maximum Ratings indicate limits beyond which damage to the device may occur. Operating Ratings indicate conditions for which the device is intended to be functional, but specific performance is not guaranteed. For guaranteed specifications and the test conditions, see the Electrical Characteristics.

Note 2: Human Body Model is 1.5 k Ω in series with 100 pF.

Note 3: Applies to both single-supply and split-supply operation. Continuous short circuit operation at elevated ambient temperature can result in exceeding the maximum allowed junction temperature at 150°C.

Note 4: The maximum power dissipation is a function of $T_{\text{J(MAX)}}$, θ_{JA} and T_A . The maximum allowable power dissipation at any ambient temperature is $P_D = (T_{\text{J(MAX)}} - T_A)/\theta_{\text{JA}}$. All numbers apply for packages soldered directly into a PC board.

Note 5: Typical Values represent the most likely parametric norm.

Note 6: All limits are guaranteed by testing or statistical analysis.

Note 7: $V^+ = 2.7\text{V}$, $V_{\text{CM}} = 1.35\text{V}$ and R_L connected to 1.35V. For Sourcing tests, $1.35\text{V} \leq V_O \leq 2.7\text{V}$. For Sinking tests, $0.5\text{V} \leq V_O \leq 1.35\text{V}$.

Note 8: Connected as Voltage Follower with 1.0V step input. Number specified is the slower of the positive and negative slew rates. Input referred, $V^+ = 2.7\text{V}$ and $R_L = 100\text{k}\Omega$ connected to 1.35V. Amp excited with 1 kHz to produce $V_O = 1 V_{\text{PP}}$.

Note 9: Bias Current guaranteed by design and processing.

3V DC Electrical Characteristics

Unless otherwise specified, all limits guaranteed for $T_J = 25^\circ\text{C}$, $V^+ = 3\text{V}$, $V^- = 0\text{V}$, $V_{\text{CM}} = V_O = V^+/2$ and $R_L > 1\text{M}\Omega$. **Boldface** limits apply at the temperature extremes.

| Symbol | Parameter | Conditions | Typ (Note 5) | LMC7111AI Limit (Note 6) | LMC7111BI Limit (Note 6) | Units |
|-----------------|------------------------------------|--|-----------------|--------------------------------|--------------------------------|----------|
| V_{CM} | Input Common-Mode Voltage Range | $V^+ = 3\text{V}$ For $\text{CMRR} \geq 50\text{ dB}$ | -0.25 | 0.0 | 0.0 | V min |
| | | | 3.2 | 3.0 2.8 | 3.0 2.8 | V max |

3.3V DC Electrical Characteristics

Unless otherwise specified, all limits guaranteed for $T_J = 25^\circ\text{C}$, $V^+ = 3.3\text{V}$, $V^- = 0\text{V}$, $V_{\text{CM}} = V_O = V^+/2$ and $R_L > 1\text{ M}\Omega$. **Boldface** limits apply at the temperature extremes.

| Symbol | Parameter | Conditions | Typ (Note 5) | LMC7111AI Limit (Note 6) | LMC7111BI Limit (Note 6) | Units |
|-----------------|---------------------------------|--|-----------------|--------------------------------|--------------------------------|----------|
| V_{CM} | Input Common-Mode Voltage Range | $V^+ = 3.3\text{V}$ For $\text{CMRR} \geq 50\text{ dB}$ | -0.25 | -0.1 0.00 | -0.1 0.00 | V min |
| | | | 3.5 | 3.4 3.2 | 3.4 3.2 | V max |

5V DC Electrical Characteristics

Unless otherwise specified, all limits guaranteed for $T_J = 25^\circ\text{C}$, $V^+ = 5\text{V}$, $V^- = 0\text{V}$, $V_{\text{CM}} = V_O = V^+/2$ and $R_L > 1\text{ M}\Omega$. **Boldface** limits apply at the temperature extremes.

| Symbol | Parameter | Conditions | Typ (Note 5) | LMC7111AI Limit (Note 6) | LMC7111BI Limit (Note 6) | Units |
|--------------------------|---------------------------------------|--|-----------------|--------------------------------|--------------------------------|------------------------------|
| V_{OS} | Input Offset Voltage | $V^+ = 5\text{V}$ | 0.9 | | | mV max |
| TCV_{OS} | Input Offset Voltage Average Drift | | 2.0 | | | $\mu\text{V}/^\circ\text{C}$ |
| I_{B} | Input Bias Current | (Note 9) | 0.1 | 1 20 | 1 20 | pA max |
| I_{OS} | Input Offset Current | (Note 9) | 0.01 | 0.5 10 | 0.5 10 | pA max |
| R_{IN} | Input Resistance | | >10 | | | Tera Ω |
| CMRR | Common Mode Rejection Ratio | $0\text{V} \leq V_{\text{CM}} \leq 5\text{V}$ | 85 | 70 | 60 | dB min |
| +PSRR | Positive Power Supply Rejection Ratio | $5\text{V} \leq V^+ \leq 10\text{V}$, $V^- = 0\text{V}$, $V_O = 2.5\text{V}$ | 85 | 70 | 60 | dB min |
| -PSRR | Negative Power Supply Rejection Ratio | $-5\text{V} \leq V^- \leq -10\text{V}$, $V^+ = 0\text{V}$, $V_O = -2.5\text{V}$ | 85 | 70 | 60 | dB min |
| V_{CM} | Input Common-Mode Voltage Range | $V^+ = 5\text{V}$ For $\text{CMRR} \geq 50\text{ dB}$ | -0.3 | -0.20 0.00 | -0.20 0.00 | V min |
| | | | 5.25 | 5.20 5.00 | 5.20 5.00 | V max |
| | | | | | | |
| C_{IN} | Common-Mode Input Capacitance | | 3 | | | pF |
| V_O | Output Swing | $V^+ = 5\text{V}$ $R_L = 100\text{ k}\Omega$ | 4.99 | 4.98 | 4.98 | Vmin |
| | | | 0.01 | 0.02 | 0.02 | Vmax |
| | | | 4.98 | 4.9 | 4.9 | Vmin |
| | | | 0.02 | 0.1 | 0.1 | Vmin |
| I_{SC} | Output Short Circuit Current | Sourcing, $V_O = 0\text{V}$ | 7 | 5 3.5 | 5 3.5 | mA min |
| | | | 7 | 5 3.5 | 5 3.5 | mA min |
| | | | | | | |
| A_{VOL} | Voltage Gain | Sourcing | 500 | | | V/mv min |
| | | Sinking | 200 | | | V/mv min |
| I_{S} | Supply Current | $V^+ = +5\text{V}$, $V_O = V^+/2$ | 25 | | | μA max |

5V AC Electrical Characteristics

Unless otherwise specified, all limits guaranteed for $T_J = 25^\circ\text{C}$, $V^+ = 5\text{V}$, $V^- = 0\text{V}$, $V_{\text{CM}} = V_O = V^+/2$ and $R_L > 1\text{ M}\Omega$. **Boldface** limits apply at the temperature extremes.

| Symbol | Parameter | Conditions | Typ (Note 5) | LMC7111AI Limit (Note 6) | LMC7111BI Limit (Note 6) | Units |
|--------|------------------------|--------------------------------------|-----------------|--------------------------------|--------------------------------|------------------|
| SR | Slew Rate | Positive Going Slew Rate (Note 8) | 0.027 | 0.015 | 0.010 | V/ μs |
| GBW | Gain-Bandwidth Product | | 50 | | | kHz |

Note 10: Absolute Maximum Ratings indicate limits beyond which damage to the device may occur. Operating Ratings indicate conditions for which the device is intended to be functional, but specific performance is not guaranteed. For guaranteed specifications and the test conditions, see the Electrical Characteristics.

Note 11: Human body model, 1.5 k Ω in series with 100 pF.

Note 12: Applies to both single-supply and split-supply operation. Continuous short circuit operation at elevated ambient temperature can result in exceeding the maximum allowed junction temperature at 150°C.

Note 13: The maximum power dissipation is a function of $T_{J(\text{max})}$, θ_{JA} and T_A . The maximum allowable power dissipation at any ambient temperature is $P_D = (T_{J(\text{max})} - T_A)/\theta_{\text{JA}}$. All numbers apply for packages soldered directly into a PC board.

Note 14: Typical Values represent the most likely parametric norm.

Note 15: All limits are guaranteed by testing or statistical analysis.

Note 16: $V^+ = 5\text{V}$, $V_{\text{CM}} = 2.5\text{V}$ and R_L connected to 2.5V. For Sourcing tests, $2.5\text{V} \leq V_O \leq 5.0\text{V}$. For Sinking tests, $0.5\text{V} \leq V_O \leq 2.5\text{V}$.

Note 17: Connected as Voltage Follower with 1.0V step input. Number specified is the slower of the positive slew rate. The negative slew rate is faster. Input referred, $V^+ = 5\text{V}$ and $R_L = 100\text{ k}\Omega$ connected to 1.5V. Amp excited with 1 kHz to produce $V_O = 1\text{ V}_{\text{pp}}$.

Note 18: Bias Current guaranteed by design and processing.

10V DC Electrical Characteristics

Unless otherwise specified, all limits guaranteed for $T_J = 25^\circ\text{C}$, $V^+ = 10\text{V}$, $V^- = 0\text{V}$, $V_{\text{CM}} = V_O = V^+/2$ and $R_L > 1\text{ M}\Omega$. **Boldface** limits apply at the temperature extremes.

| Symbol | Parameter | Conditions | Typ (Note 5) | LMC7111AI Limit (Note 6) | LMC7111BI Limit (Note 6) | Units |
|--------------------------|--|---|-----------------|--------------------------------|--------------------------------|------------------------------|
| V_{OS} | Input Offset Voltage | $V^+ = 10\text{V}$ | 0.9 | 3 5 | 7 9 | mV max |
| TCV_{OS} | Input Offset Voltage Average Drift | | 2.0 | | | $\mu\text{V}/^\circ\text{C}$ |
| I_{B} | Input Bias Current | | 0.1 | 1 20 | 1 20 | pA max |
| I_{OS} | Input Offset Current | | 0.01 | 0.5 10 | 0.5 10 | pA max |
| R_{IN} | Input Resistance | | >10 | | | Tera Ω |
| +PSRR | Positive Power Supply Rejection Ratio | $5\text{V} \leq V^+ \leq 10\text{V}$, $V^- = 0\text{V}$, $V_O = 2.5\text{V}$ | 80 | | | dB min |
| -PSRR | Negative Power Supply Rejection Ratio | $-5\text{V} \leq V^- \leq -10\text{V}$, $V^- = 0\text{V}$, $V_O = 2.5\text{V}$ | 80 | | | dB min |
| V_{CM} | Input Common-Mode Voltage Range | $V^+ = 10\text{V}$ For $\text{CMRR} \geq 50\text{ dB}$ | -0.2 | -0.15 0.00 | -0.15 0.00 | V min |
| | | | 10.2 | 10.15 10.00 | 10.15 10.00 | V max |
| C_{IN} | Common-Mode Input Capacitance | | 3 | | | pF |
| I_{SC} | Output Short Circuit Current (Note 9) | Sourcing, $V_O = 0\text{V}$ | 30 | 20 7 | 20 7 | mA min |
| | | Sinking, $V_O = 10\text{V}$ | 30 | 20 7 | 20 7 | mA min |

10V DC Electrical Characteristics (Continued)

Unless otherwise specified, all limits guaranteed for $T_J = 25^\circ\text{C}$, $V^+ = 10\text{V}$, $V^- = 0\text{V}$, $V_{\text{CM}} = V_O = V^+/2$ and $R_L > 1\text{ M}\Omega$. **Bold-face** limits apply at the temperature extremes.

| Symbol | Parameter | Conditions | Typ (Note 5) | LMC7111AI Limit (Note 6) | LMC7111BI Limit (Note 6) | Units |
|------------------|-------------------------------------|--|-----------------|--------------------------------|--------------------------------|----------------------|
| A_{VOL} | Voltage Gain 100 k Ω Load | Sourcing | 500 | | | V/mv min |
| | | Sinking | 200 | | | V/mv min |
| I_S | Supply Current | $V^+ = +10\text{V}$, $V_O = V^+/2$ | 25 | 50 65 | 60 75 | μA max |
| V_O | Output Swing | $V^+ = 10\text{V}$ | 9.99 | 9.98 | 9.98 | Vmin |
| | | $R_L = 100\text{ k}\Omega$ | 0.01 | 0.02 | 0.02 | Vmax |
| | | $V^+ = 10\text{V}$ | 9.98 | 9.9 | 9.9 | Vmin |
| | | $R_L = 10\text{ k}\Omega$ | 0.02 | 0.1 | 0.1 | Vmin |

10V AC Electrical Characteristics

Unless otherwise specified, all limits guaranteed for $T_J = 25^\circ\text{C}$, $V^+ = 10\text{V}$, $V^- = 0\text{V}$, $V_{\text{CM}} = V_O = V^+/2$ and $R_L > 1\text{ M}\Omega$. **Bold-face** limits apply at the temperature extremes.

| Symbol | Parameter | Conditions | Typ (Note 5) | LMC7111AI Limit (Note 6) | LMC7111BI Limit (Note 6) | Units |
|----------|---------------------------------|---|-----------------|--------------------------------|--------------------------------|--------------------------------------|
| SR | Slew Rate | (Note 8) | 0.03 | | | V/ μs |
| GBW | Gain-Bandwidth Product | | 50 | | | kHz |
| ϕ_m | Phase Margin | | 50 | | | deg |
| G_m | Gain Margin | | 15 | | | dB |
| | Input-Referred Voltage Noise | $f = 1\text{ kHz}$ $V_{\text{CM}} = 1\text{V}$ | 110 | | | $\frac{\text{nV}}{\sqrt{\text{Hz}}}$ |
| | Input-Referred Current Noise | $f = 1\text{ kHz}$ | 0.03 | | | $\frac{\text{pA}}{\sqrt{\text{Hz}}}$ |

Note 19: Absolute Maximum Ratings indicate limits beyond which damage to the device may occur. Operating Ratings indicate conditions for which the device is intended to be functional, but specific performance is not guaranteed. For guaranteed specifications and the test conditions, see the Electrical Characteristics.

Note 20: Human body model, 1.5 k Ω in series with 100 pF.

Note 21: Applies to both single-supply and split-supply operation. Continuous short circuit operation at elevated ambient temperature can result in exceeding the maximum allowed junction temperature at 150°C.

Note 22: The maximum power dissipation is a function of $T_{J(\text{max})}$, θ_{JA} and T_A . The maximum allowable power dissipation at any ambient temperature is $P_D = (T_{J(\text{max})} - T_A)/\theta_{\text{JA}}$. All numbers apply for packages soldered directly into a PC board.

Note 23: Typical Values represent the most likely parametric norm.

Note 24: All limits are guaranteed by testing or statistical analysis.

Note 25: $V^+ = 10\text{V}$, $V_{\text{CM}} = 5\text{V}$ and R_L connected to 5V. For Sourcing tests, $5\text{V} \leq V_O \leq 10\text{V}$. For Sinking tests, $0.5\text{V} \leq V_O \leq 5\text{V}$.

Note 26: Connected as Voltage Follower with 1.0V step input. Number specified is the slower of the positive and negative slew rates. Input referred, $V^+ = 10\text{V}$ and $R_L = 100\text{ k}\Omega$ connected to 5V. Amp excited with 1 kHz to produce $V_O = 2\text{ V}_{\text{PP}}$.

Note 27: Operation near absolute maximum limits will adversely affect reliability.

Typical Performance Characteristics

$T_A = 25^\circ\text{C}$ unless specified, Single Supply

Supply Current vs. Supply Voltage

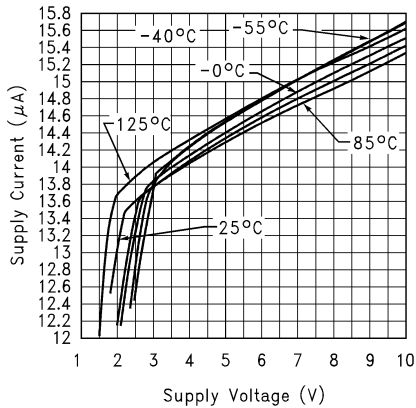

01235203

Voltage Noise vs. Frequency

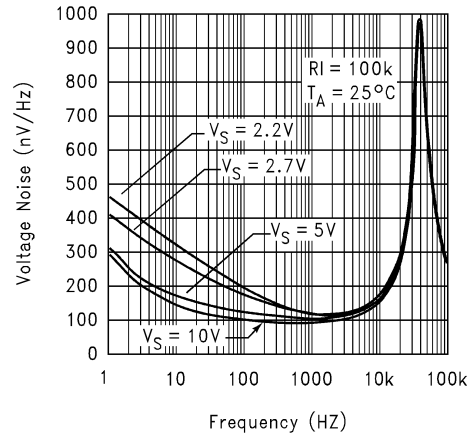

01235204

2.7V Performance

Offset Voltage vs. Common Mode Voltage @ 2.7V

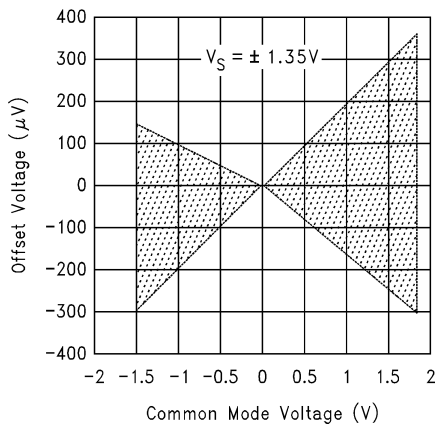

01235268

Sinking Output vs. Output Voltage

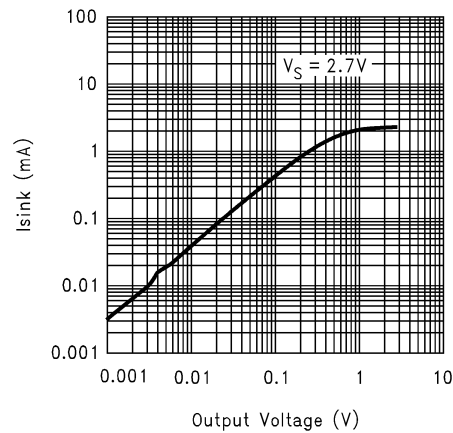

01235220

Sourcing Output vs. Output Voltage

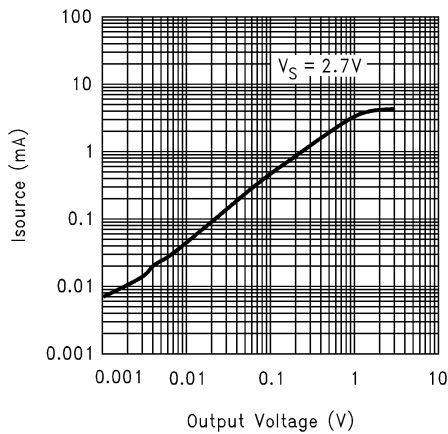

01235221

Gain and Phase vs. Capacitive Load @ 2.7V

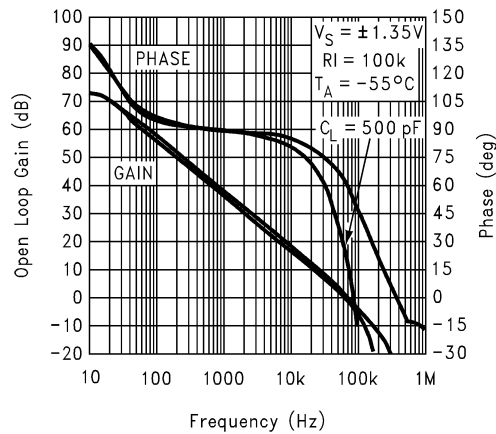

01235222

2.7V Performance (Continued)

Gain and Phase vs. Capacitive Load @ 2.7V

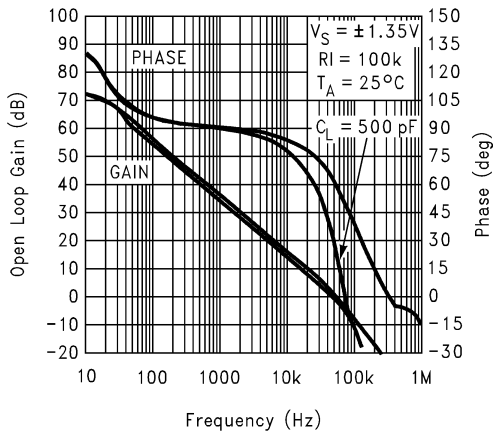

01235223

Gain and Phase vs. Capacitive Load @ 2.7V

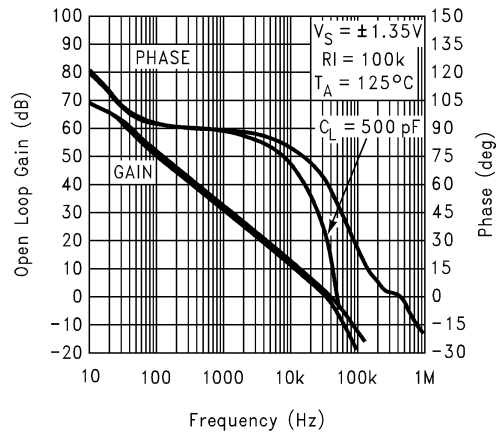

01235224

3V Performance

Voltage Noise vs. Common Mode Voltage @ 3V

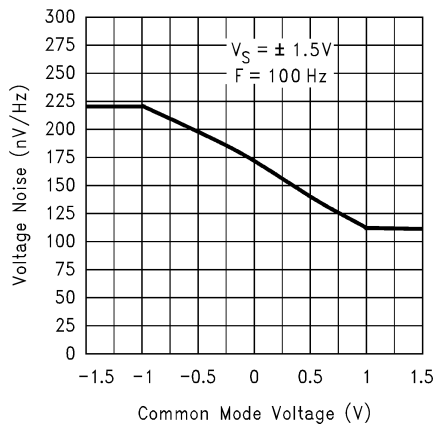

01235225

Output Voltage vs. Input Voltage @ 3V

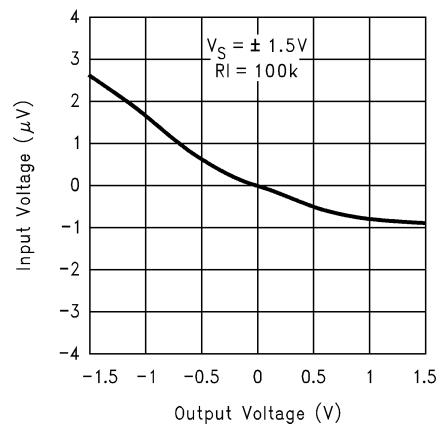

01235226

Offset Voltage vs. Common Mode Voltage @ 3V

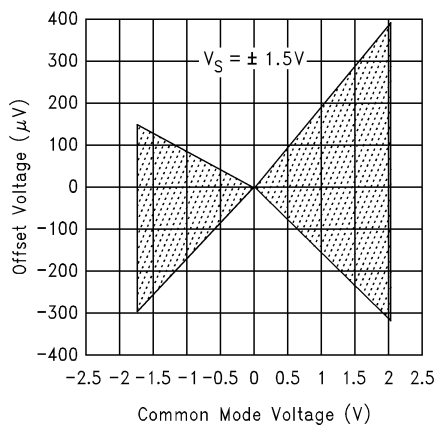

01235227

Sourcing Output vs. Output Voltage

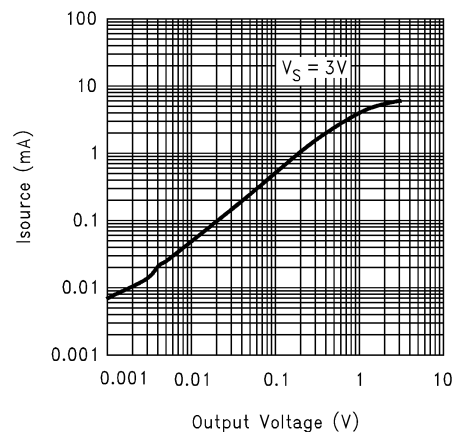

01235228

3V Performance (Continued)

Sinking Output vs. Output Voltage

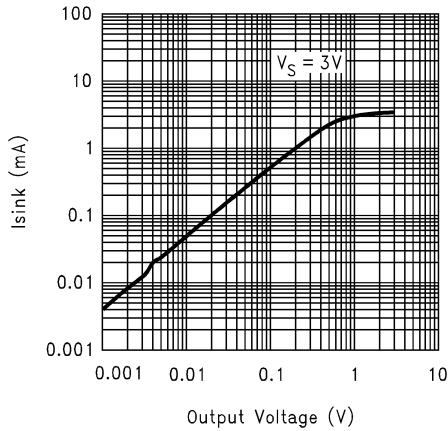

01235229

Gain and Phase vs. Capacitive Load @ 3V

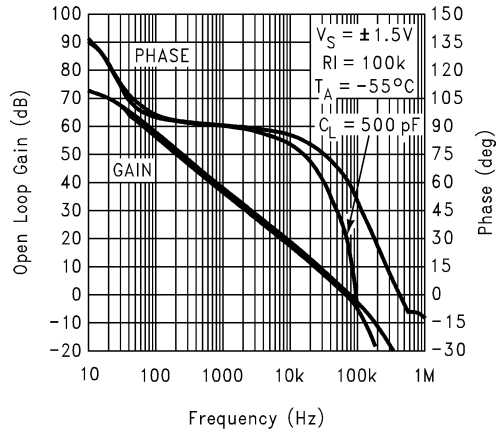

01235230

Gain and Phase vs. Capacitive Load @ 3V

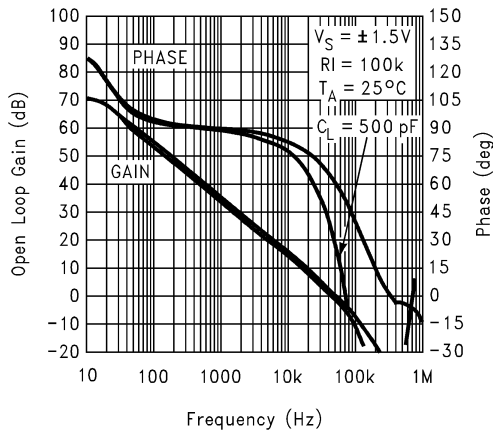

01235231

Gain and Phase vs. Capacitive Load @ 3V

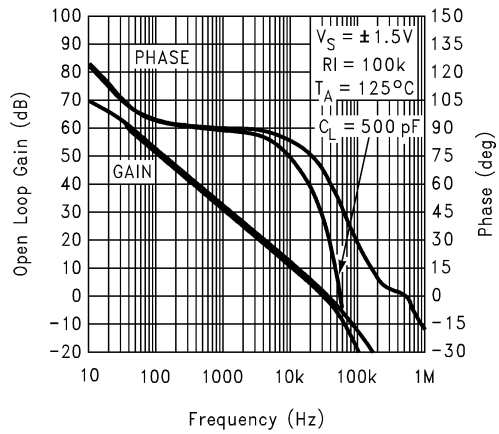

01235232

5V Performance

Voltage Noise vs. Common Mode Voltage @ 5V

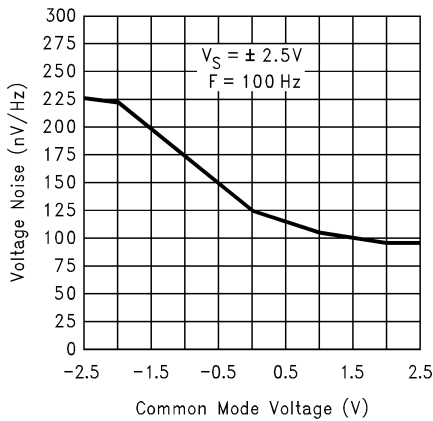

01235233

Output Voltage vs. Input Voltage @ 5V

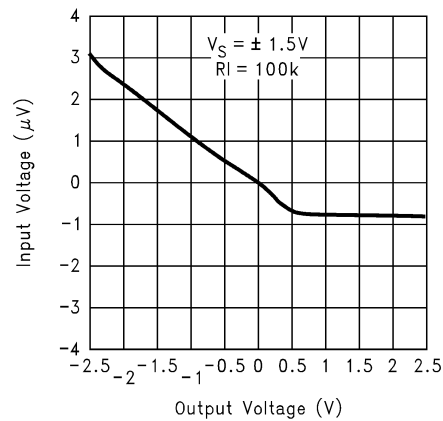

01235234

5V Performance (Continued)

Offset Voltage vs. Common Mode Voltage @ 5V

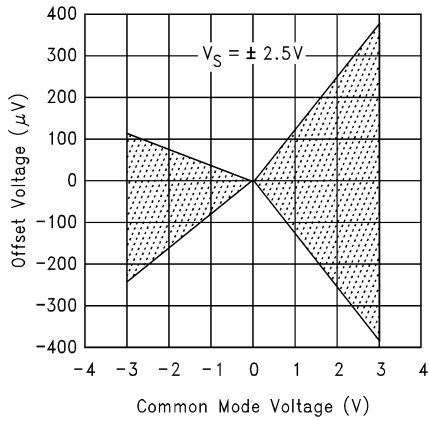

01235235

Sourcing Output vs. Output Voltage

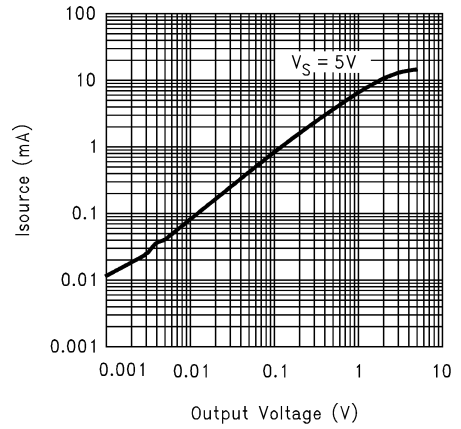

01235236

Sinking Output vs. Output Voltage

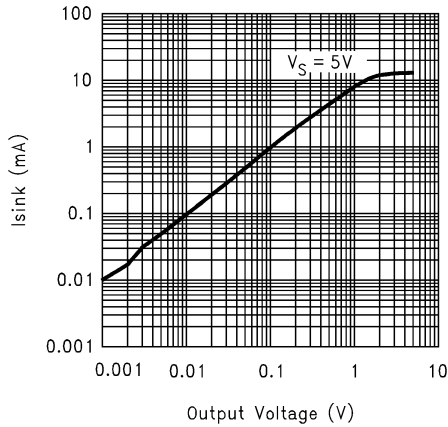

01235237

Gain and Phase vs. Capacitive Load @ 5V

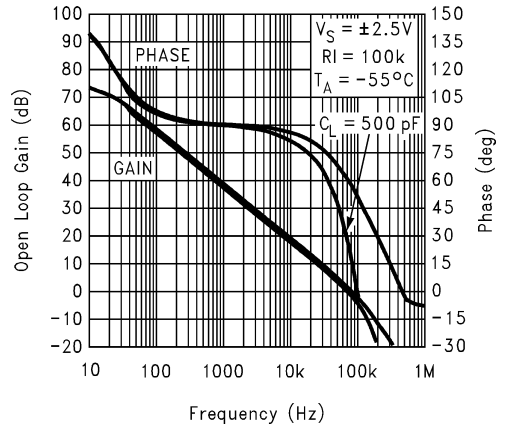

01235238

Gain and Phase vs. Capacitive Load @ 5V

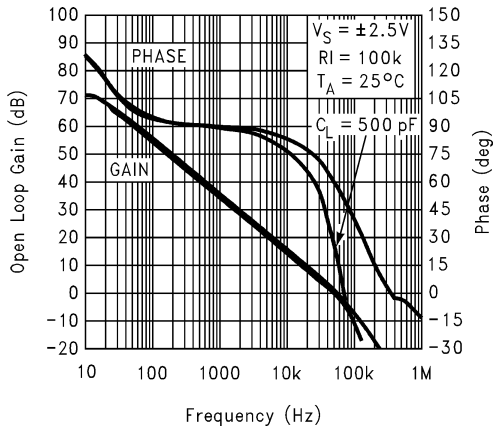

01235239

Gain and Phase vs. Capacitive Load @ 5V

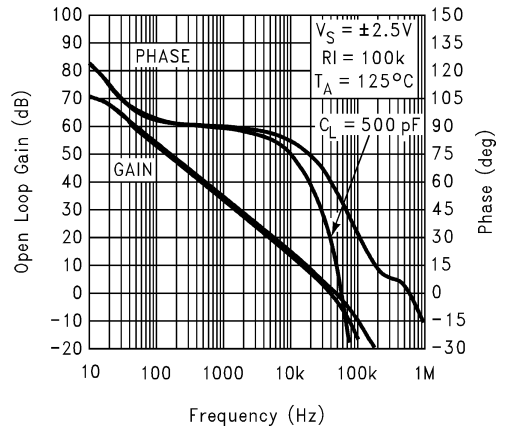

01235240

5V Performance (Continued)

Non-Inverting Small Signal Pulse Response at 5V

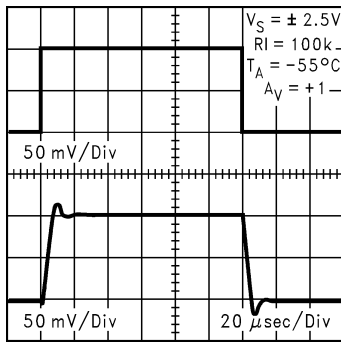

01235241

Non-Inverting Small Signal Pulse Response at 5V

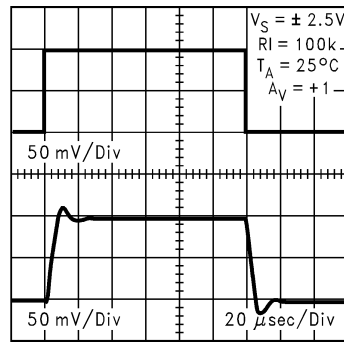

01235242

Non-Inverting Small Signal Pulse Response at 5V

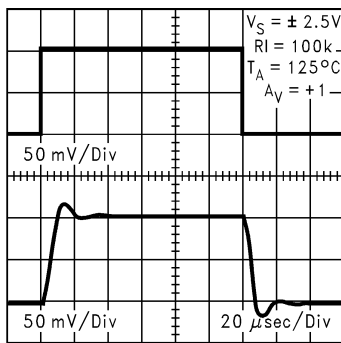

01235243

Non-Inverting Large Signal Pulse Response at 5V

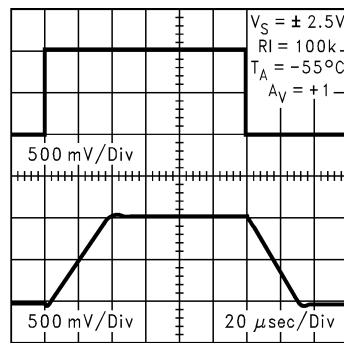

01235244

Non-Inverting Large Signal Pulse Response at 5V

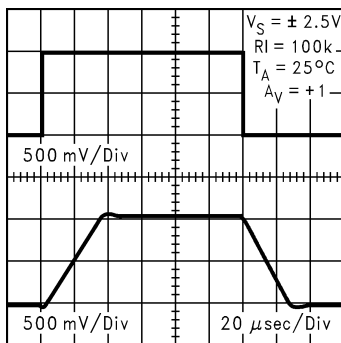

01235245

Non-Inverting Large Signal Pulse Response at 5V

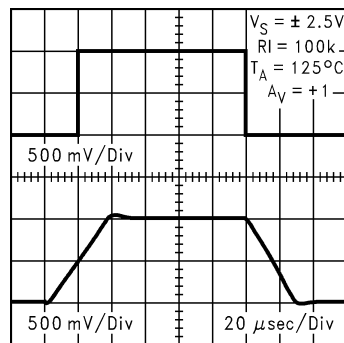

01235246

5V Performance (Continued)

Inverting Small Signal Pulse Response at 5V

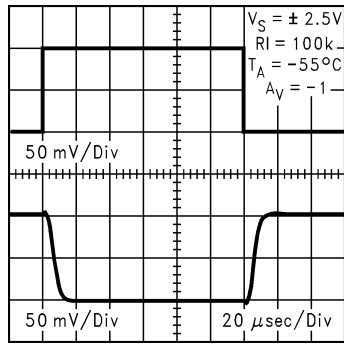

01235247

Inverting Small Signal Pulse Response at 5V

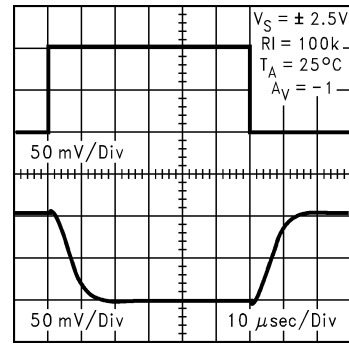

01235248

Inverting Small Signal Pulse Response at 5V

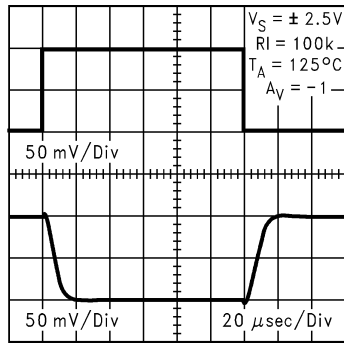

01235249

Inverting Large Signal Pulse Response at 5V

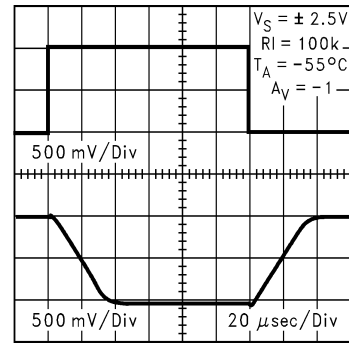

01235250

Inverting Large Signal Pulse Response at 5V

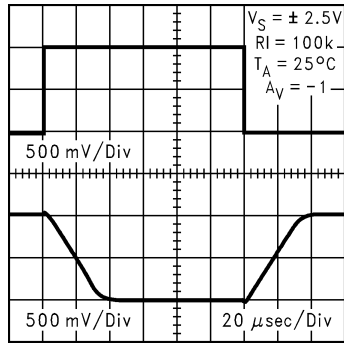

01235251

Inverting Large Signal Pulse Response at 5V

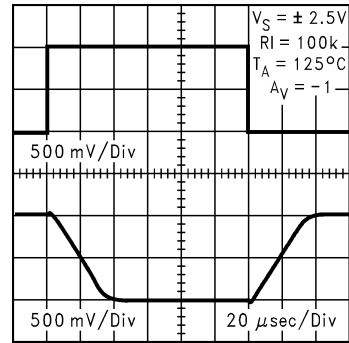

01235252

10V Performance

Voltage Noise vs. Common Mode Voltage @ 10V

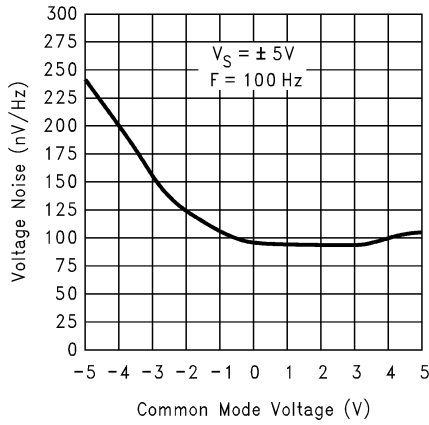

01235253

Output Voltage vs. Input Voltage @ 10V

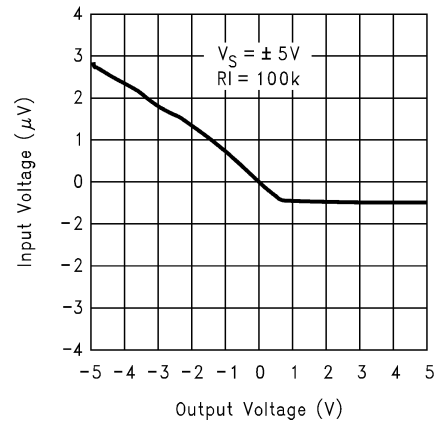

01235254

Offset Voltage vs. Common Mode Voltage @ 10V

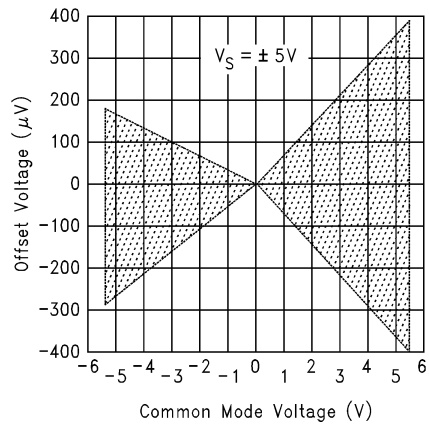

01235255

Sourcing Output vs. Output Voltage

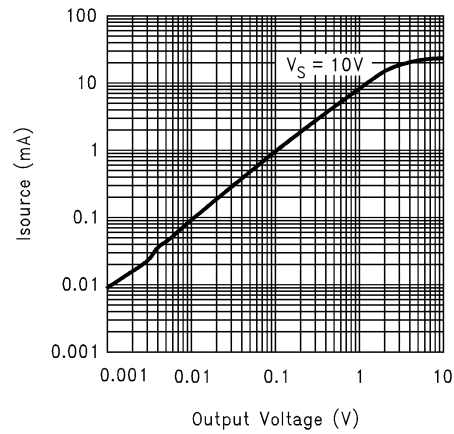

01235256

Sinking Output vs. Output Voltage

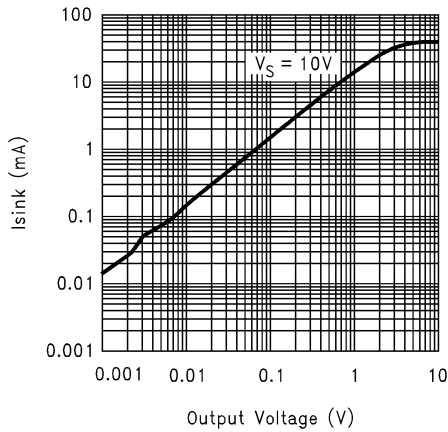

01235257

Gain and Phase vs. Capacitive Load @ 10V

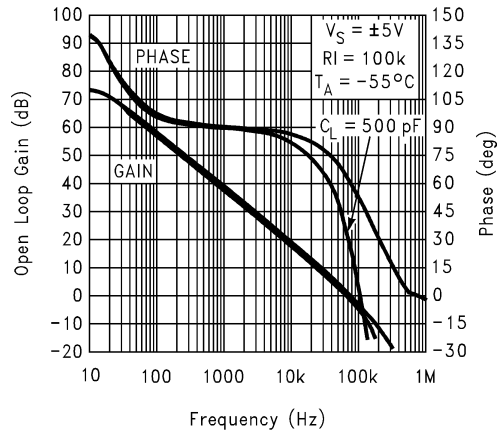

01235258

10V Performance (Continued)

Gain and Phase vs. Capacitive Load @ 10V

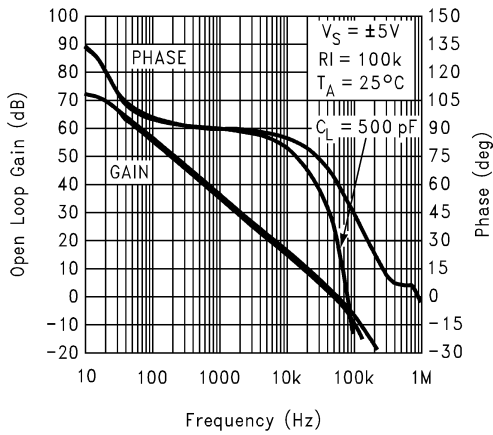

01235259

Gain and Phase vs. Capacitive Load @ 10V

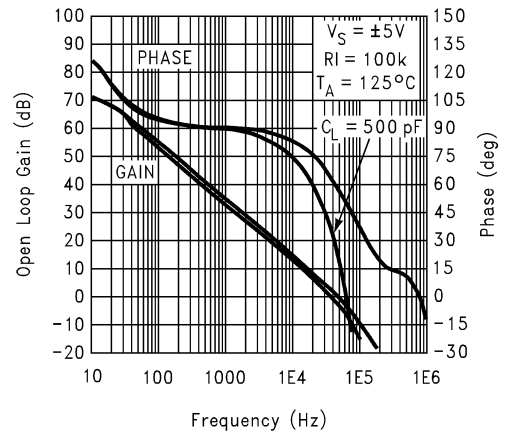

01235260

Non-Inverting Small Signal Pulse Response at 10V

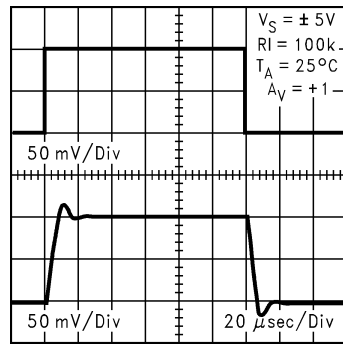

01235261

Non-Inverting Large Signal Pulse Response at 10V

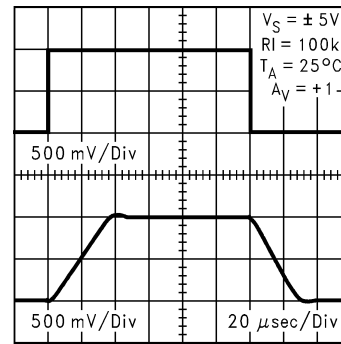

01235262

Inverting Small Signal Pulse Response at 10V

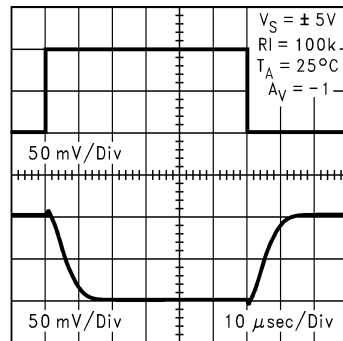

01235263

Inverting Large Signal Pulse Response at 10V

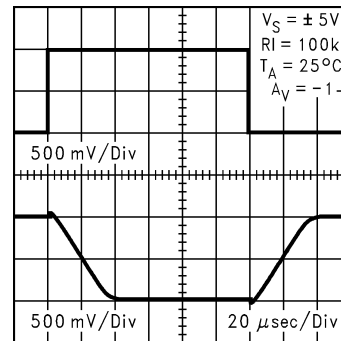

01235264

Application Information

1.0 BENEFITS OF THE LMC7111 TINY AMP

Size

The small footprint of the SOT 23-5 packaged Tiny amp, (0.120 x 0.118 inches, 3.05 x 3.00 mm) saves space on printed circuit boards, and enable the design of smaller electronic products. Because they are easier to carry, many customers prefer smaller and lighter products.

Height

The height (0.056 inches, 1.43 mm) of the Tiny amp makes it possible to use it in PCMCIA type III cards.

Signal Integrity

Signals can pick up noise between the signal source and the amplifier. By using a physically smaller amplifier package, the Tiny amp can be placed closer to the signal source, reducing noise pickup and increasing signal integrity. The Tiny amp can also be placed next to the signal destination, such as a buffer for the reference of an analog to digital converter.

Simplified Board Layout

The Tiny amp can simplify board layout in several ways. First, by placing an amp where amps are needed, instead of routing signals to a dual or quad device, long pc traces may be avoided.

By using multiple Tiny amps instead of duals or quads, complex signal routing and possibly crosstalk can be reduced.

DIPs available for prototyping

LMC7111 amplifiers packaged in conventional 8-pin dip packages can be used for prototyping and evaluation without the need to use surface mounting in early project stages.

Low Supply Current

The typical 25 μ A supply current of the LMC7111 extends battery life in portable applications, and may allow the reduction of the size of batteries in some applications.

Wide Voltage Range

The LMC7111 is characterized at 2.7V, 3V, 3.3V, 5V and 10V. Performance data is provided at these popular voltages. This wide voltage range makes the LMC7111 a good choice for devices where the voltage may vary over the life of the batteries.

2.0 INPUT COMMON MODE VOLTAGE RANGE

The LMC7111 does not exhibit phase inversion when an input voltage exceeds the negative supply voltage.

The absolute maximum input voltage is 300 mV beyond either rail at room temperature. Voltages greatly exceeding this maximum rating can cause excessive current to flow in or out of the input pins, adversely affecting reliability.

Applications that exceed this rating must externally limit the maximum input current to ± 5 mA with an input resistor as shown in *Figure 1*.

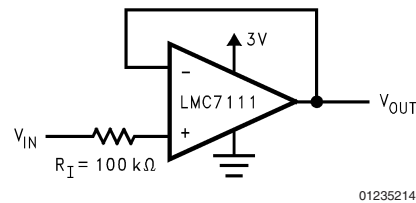

FIGURE 1. R_I Input Current Protection for Voltages Exceeding the Supply Voltage

3.0 CAPACITIVE LOAD TOLERANCE

The LMC7111 can typically directly drive a 300 pF load with $V_S = 10V$ at unity gain without oscillating. The unity gain follower is the most sensitive configuration. Direct capacitive loading reduces the phase margin of op-amps. The combination of the op-amp's output impedance and the capacitive load induces phase lag. This results in either an underdamped pulse response or oscillation.

Capacitive load compensation can be accomplished using resistive isolation as shown in *Figure 2*. This simple technique is useful for isolating the capacitive input of multiplexers and A/D converters.

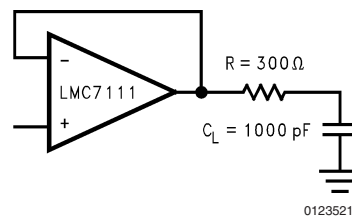

FIGURE 2. Resistive Isolation of a 330 pF Capacitive Load

4.0 COMPENSATING FOR INPUT CAPACITANCE WHEN USING LARGE VALUE FEEDBACK RESISTORS

When using very large value feedback resistors, (usually > 500 k Ω) the large feedback resistance can react with the input capacitance due to transducers, photodiodes, and circuit board parasitics to reduce phase margins.

The effect of input capacitance can be compensated for by adding a feedback capacitor. The feedback capacitor (as in *Figure 3*), C_f is first estimated by:

$$\frac{1}{2\pi R_1 C_{IN}} \geq \frac{1}{2\pi R_2 C_f}$$

or

$$R_1 C_{IN} \leq R_2 C_f$$

which typically provides significant overcompensation.

Printed circuit board stray capacitance may be larger or smaller than that of a breadboard, so the actual optimum value for C_f may be different. The values of C_f should be checked on the actual circuit. (Refer to the LMC660 quad CMOS amplifier data sheet for a more detailed discussion.)

Application Information (Continued)

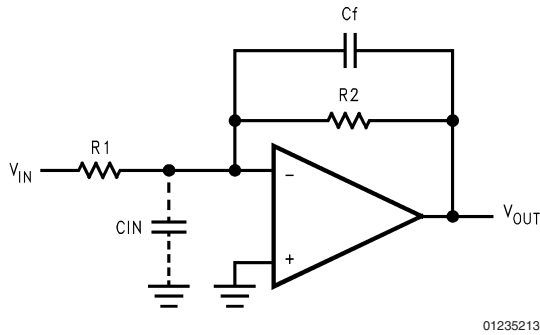

01235213

FIGURE 3. Cancelling the Effect of Input Capacitance

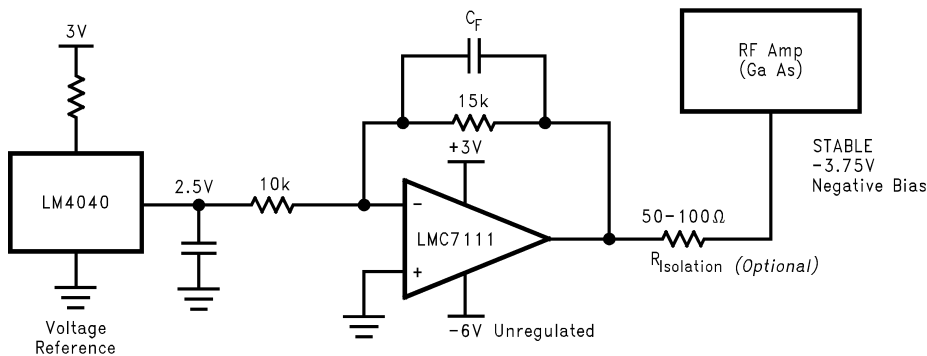

01235217

C_f and $R_{isolation}$ prevent oscillations when driving capacitive loads.

FIGURE 4. Stable Negative Bias

7.0 REFERENCE BUFFER FOR A-TO-D CONVERTERS

The LMC7111 can be used as a voltage reference buffer for analog-to-digital converters. This works best for A-to-D converters whose reference input is a static load, such as dual slope integrating A-to-Ds. Converters whose reference input is a dynamic load (the reference current changes with time) may need a faster device, such as the LMC7101 or the LMC7131.

The small size of the LMC7111 allows it to be placed close to the reference input. The low supply current (25 μ A typical) saves power.

For A-to-D reference inputs which require higher accuracy and lower offset voltage, please see the LMC6462 datasheet. The LMC6462 has performance similar to the LMC7111. The LMC6462 is available in two grades with reduced input voltage offset.

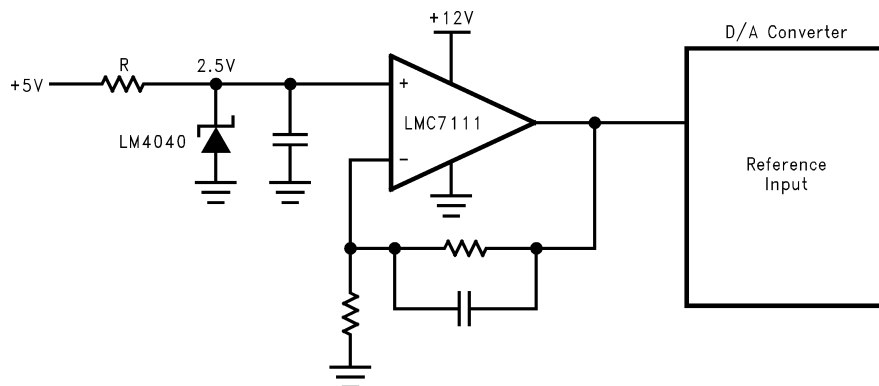

01235218

Application Information (Continued)

8.0 DUAL AND QUAD DEVICES WITH SIMILAR PERFORMANCE

The LMC6462 and LMC6464 are dual and quad devices with performance similar to the LMC7111. They are available in both conventional through-hole and surface mount packaging. Please see the LMC6462/4 datasheet for details.

9.0 SPICE MACROMODEL

A SPICE macromodel is available for the LMC7111. This model includes simulation of:

- Input common-mode voltage range
- Frequency and transient response
- Quiescent and dynamic supply current
- Output swing dependence on loading conditions and many more characteristics as listed on the macro model disk. Contact your local National Semiconductor sales office to obtain an operational amplifier spice model library disk.

10.0 ADDITIONAL SOT23-5 TINY DEVICES

National Semiconductor has additional parts available in the space saving SOT23 Tiny package, including amplifiers, voltage references, and voltage regulators. These devices

include—

- LMC7101** 1 MHz gain-bandwidth rail-to-rail input and output amplifier—high input impedance and high gain, 700 μ A typical current 2.7V, 3V, 5V and 15V specifications.
- LM7131** Tiny Video amp with 70 MHz gain bandwidth. Specified at 3V, 5V and \pm 5V supplies.
- LMC7211** Comparator in a tiny package with rail-to-rail input and push-pull output. Typical supply current of 7 μ A. Typical propagation delay of 7 μ s. Specified at 2.7V, 5V and 15V supplies.
- LMC7221** Comparator with an open drain output for use in mixed voltage systems. Similar to the LMC7211, except the output can be used with a pull-up resistor to a voltage different than the supply voltage.
- LP2980** Micropower SOT 50 mA Ultra Low-Dropout Regulator.
- LM4040** Precision micropower shunt voltage reference. Fixed voltages of 2.5000V, 4.096V, 5.000V, 8.192V and 10.000V.
- LM4041** Precision micropower shunt voltage reference 1.225V and adjustable.

Contact your National Semiconductor representative for the latest information.

SOT-23-5 Tape and Reel Specification

TAPE FORMAT

| Tape Section | # Cavities | Cavity Status | Cover Tape Status |
|-----------------------|------------|---------------|-------------------|
| Leader (Start End) | 0 (min) | Empty | Sealed |
| | 75 (min) | Empty | Sealed |
| Carrier | 3000 | Filled | Sealed |
| | 1000 | Filled | Sealed |
| Trailer (Hub End) | 125 (min) | Empty | Sealed |
| | 0 (min) | Empty | Sealed |

TAPE DIMENSIONS

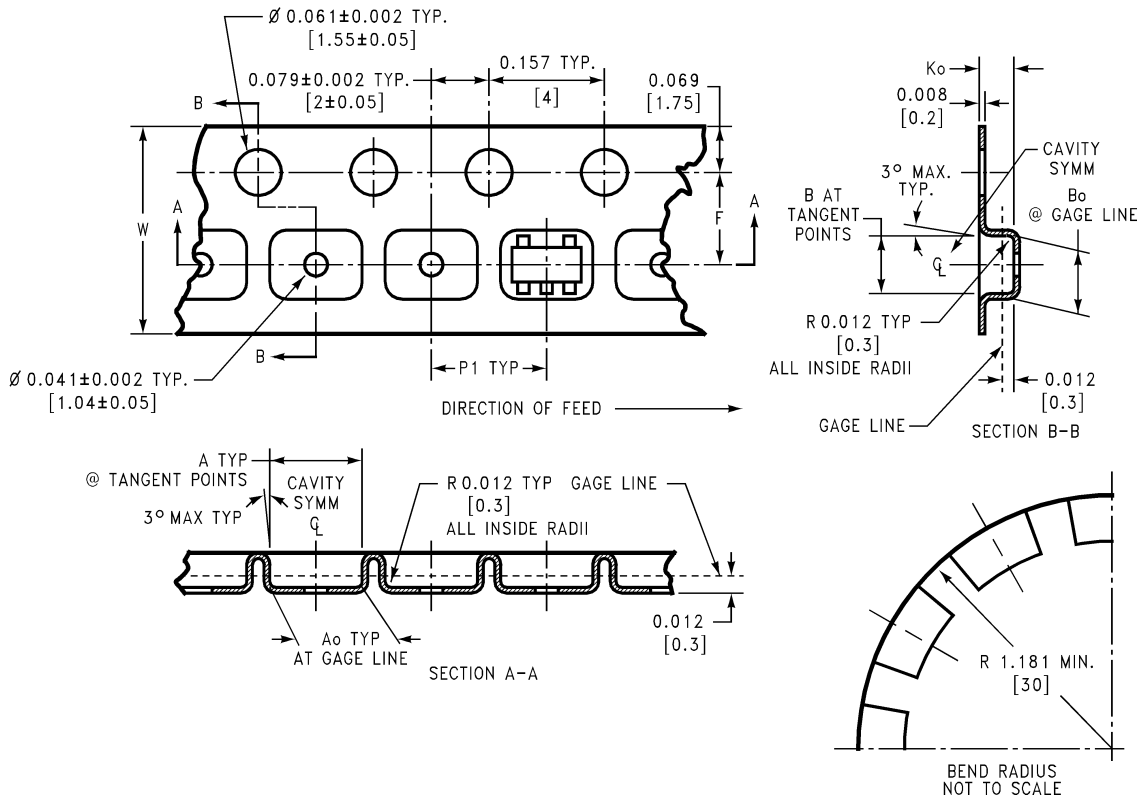

01235215

| | | | | | | | | |
|-------------|--------------|--------------------|--------------|--------------------|----------------------|----------------------|--------------------|----------------------|
| 8 mm | 0.130 | 0.124 | 0.130 | 0.126 | 0.138 ± 0.002 | 0.055 ± 0.004 | 0.157 | 0.315 ± 0.012 |
| | (3.3) | (3.15) | (3.3) | (3.2) | (3.5 ± 0.05) | (1.4 ± 0.11) | (4) | (8 ± 0.3) |
| Tape Size | DIM A | DIM A ₀ | DIM B | DIM B ₀ | DIM F | DIM K ₀ | DIM P ₁ | DIM W |

SOT-23-5 Tape and Reel Specification (Continued)

REEL DIMENSIONS

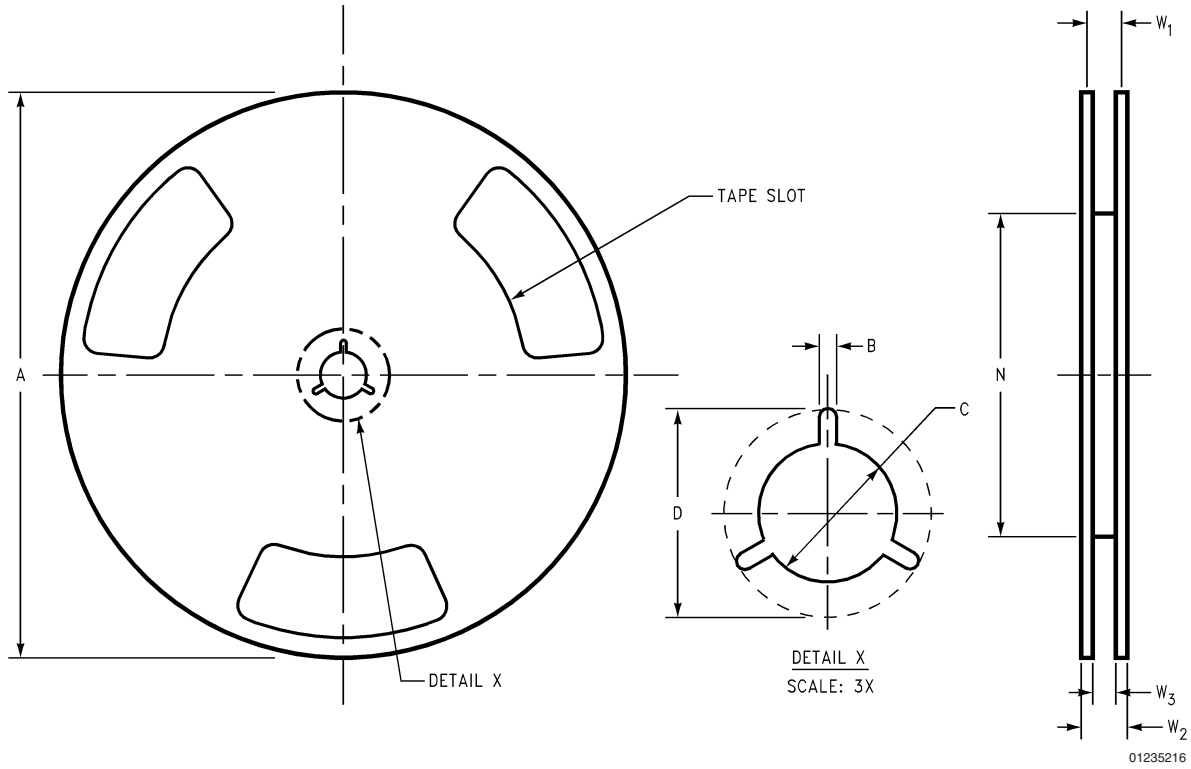

01235216

| | | | | | | | | |
|-------------|---------------|--------------|--------------|--------------|--------------|-----------------------------|--------------|--------------------------|
| 8 mm | 7.00 | 0.059 | 0.512 | 0.795 | 2.165 | 0.331 + 0.059/-0.000 | 0.567 | W1 + 0.078/-0.039 |
| | 330.00 | 1.50 | 13.00 | 20.20 | 55.00 | 8.40 + 1.50/-0.00 | 14.40 | W1 + 2.00/-1.00 |
| Tape Size | A | B | C | D | N | W1 | W2 | W3 |

Physical Dimensions inches (millimeters)

unless otherwise noted

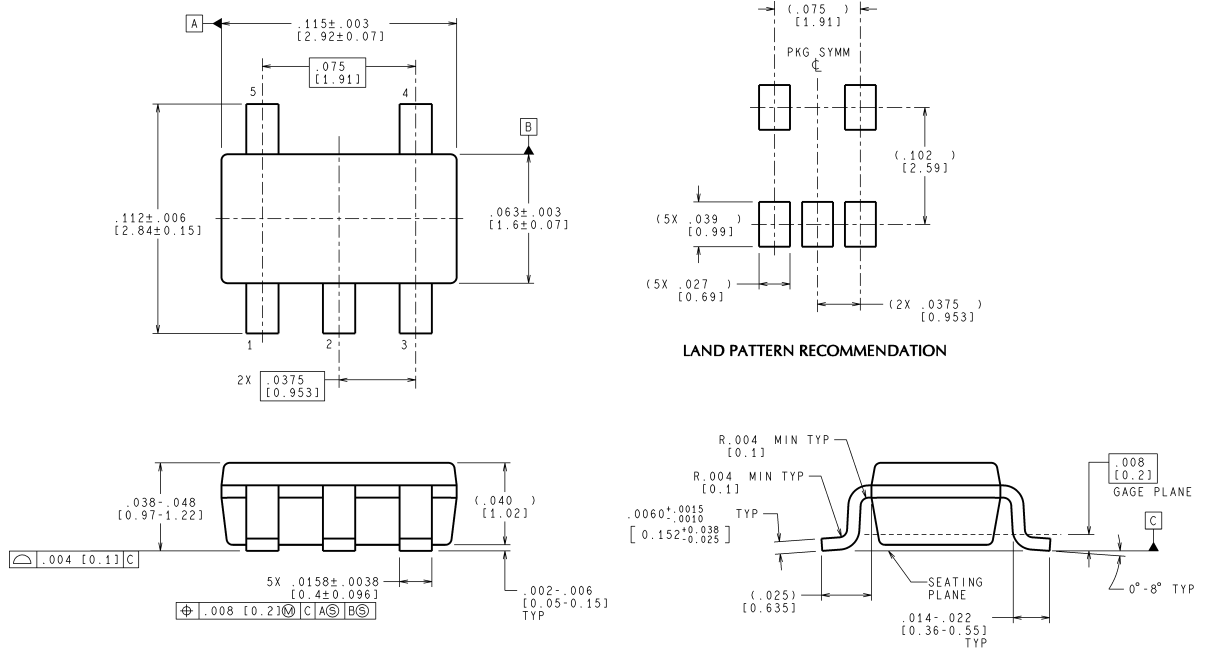

MF05A (Rev C)

5-Pin SOT23 NS Package Number MF05A

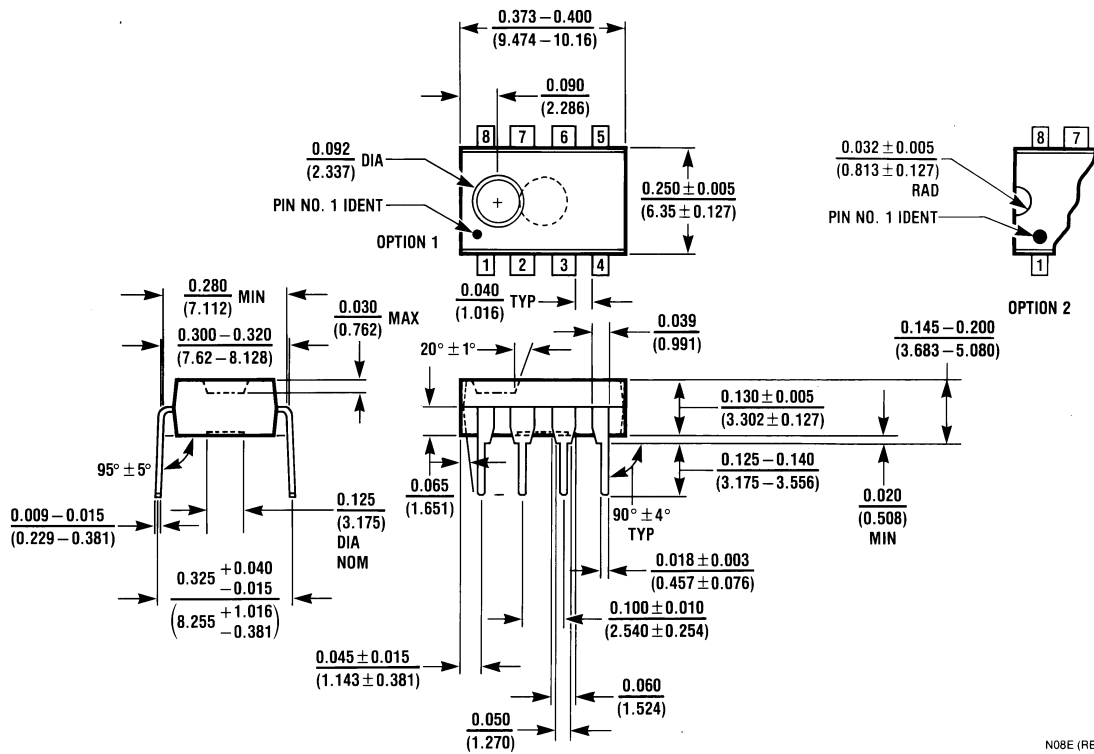

N08E (REV F)

8-Pin Molded DIP 8-Lead (0.300" Wide) Molded Dual-In-Line Package NS Package Number N08E

Notes

National does not assume any responsibility for use of any circuitry described, no circuit patent licenses are implied and National reserves the right at any time without notice to change said circuitry and specifications.

For the most current product information visit us at www.national.com.

LIFE SUPPORT POLICY

NATIONAL'S PRODUCTS ARE NOT AUTHORIZED FOR USE AS CRITICAL COMPONENTS IN LIFE SUPPORT DEVICES OR SYSTEMS WITHOUT THE EXPRESS WRITTEN APPROVAL OF THE PRESIDENT AND GENERAL COUNSEL OF NATIONAL SEMICONDUCTOR CORPORATION. As used herein:

1. Life support devices or systems are devices or systems which, (a) are intended for surgical implant into the body, or (b) support or sustain life, and whose failure to perform when properly used in accordance with instructions for use provided in the labeling, can be reasonably expected to result in a significant injury to the user.
2. A critical component is any component of a life support device or system whose failure to perform can be reasonably expected to cause the failure of the life support device or system, or to affect its safety or effectiveness.

BANNED SUBSTANCE COMPLIANCE

National Semiconductor follows the provisions of the Product Stewardship Guide for Customers (CSP-9-111C2) and Banned Substances and Materials of Interest Specification (CSP-9-111S2) for regulatory environmental compliance. Details may be found at: www.national.com/quality/green.

Lead free products are RoHS compliant.



National Semiconductor
Americas Customer
Support Center
Email: new.feedback@nsc.com
Tel: 1-800-272-9959

www.national.com

National Semiconductor
Europe Customer Support Center
Fax: +49 (0) 180-530 85 86
Email: europe.support@nsc.com
Deutsch Tel: +49 (0) 69 9508 6208
English Tel: +44 (0) 870 24 0 2171
Français Tel: +33 (0) 1 41 91 8790

National Semiconductor
Asia Pacific Customer
Support Center
Email: ap.support@nsc.com

National Semiconductor
Japan Customer Support Center
Fax: 81-3-5639-7507
Email: jpn.feedback@nsc.com
Tel: 81-3-5639-7560