

Proximity Switch

TCA 305
TCA 355

Bipolar IC

Features

- Lower open-loop current consumption; $I_s < 1 \text{ mA}$
- Lower output saturation voltage
- The temperature dependence of the switching distance is lower and compensation of the resonant circuit TC (temperature coefficient) is easier
- The sensitivity is higher, so that larger switching distances are possible and coils of a lower quality can be used
- The switching hysteresis remains constant as regards temperature, supply voltage and switching distance
- The TCA 305 even functions without external integrating capacitor. With an external capacitor (or with RC combination) good noise immunity can be achieved
- The outputs are temporarily short-circuit proof (approx. 10 s to 1 min depending on package)
- The outputs are disabled when $V_s < \text{approx. } 4.5 \text{ V}$ and are enabled when the oscillator stabilizes (from $V_{s \text{ min}} = 5 \text{ V}$)
- Higher switching frequencies can be obtained
- Pb-free lead plating; RoHS compliant

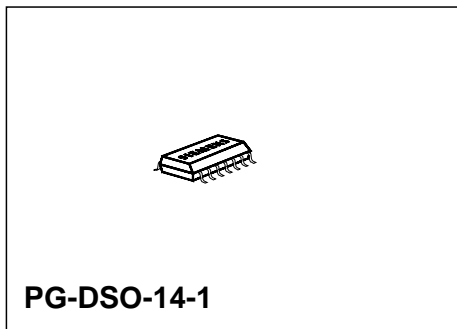
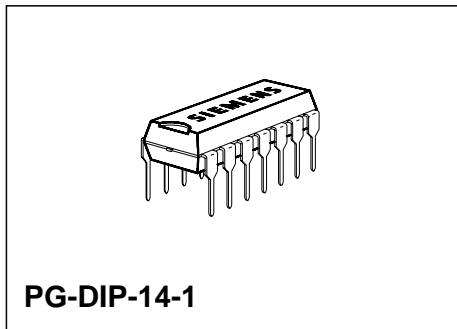
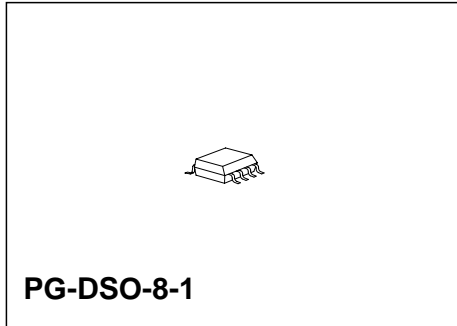

Type	Ordering Code	Package
■ TCA 305 A	Q67000-A2291	PG-DIP-14-1
TCA 305 G	Q67000-A2305	PG-DSO-14-1 (SMD)
TCA 355 G	Q67000-A2444	PG-DSO-8-1 (SMD)

■ Not for new design

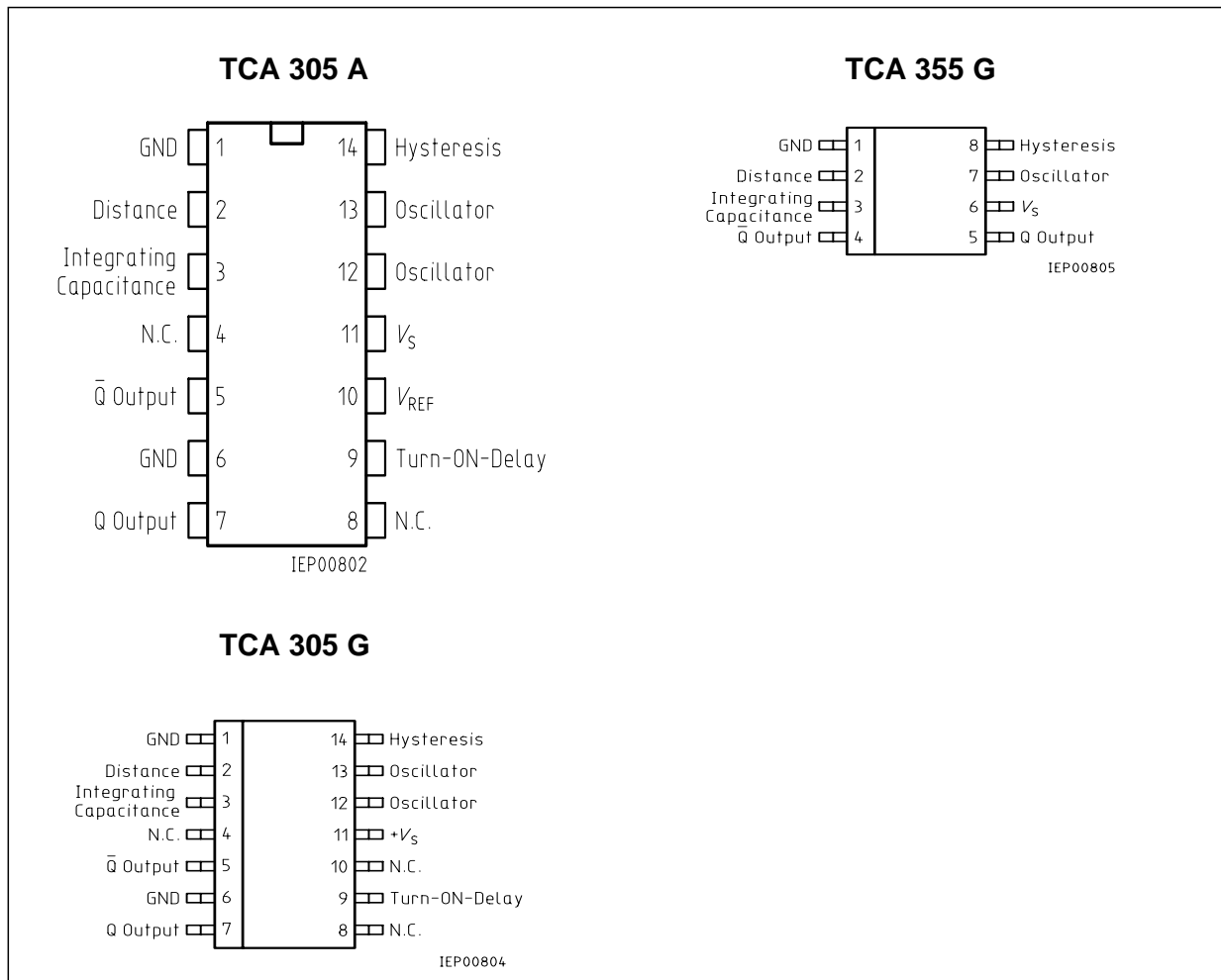

Pin Configurations (top view)

The devices TCA 305 and TCA 355 contain all the functions necessary to design inductive proximity switches. By approaching a standard metal plate to the coil, the resonant circuit is damped and the outputs are switched.

Operation Schematic: see TCA 205

The types TCA 305 and TCA 355 have been developed from the type TCA 205 and are outstanding for the following characteristics:

Logic Functions

Oscillator	Outputs	
	Q	
not damped	H	L
damped	L	H

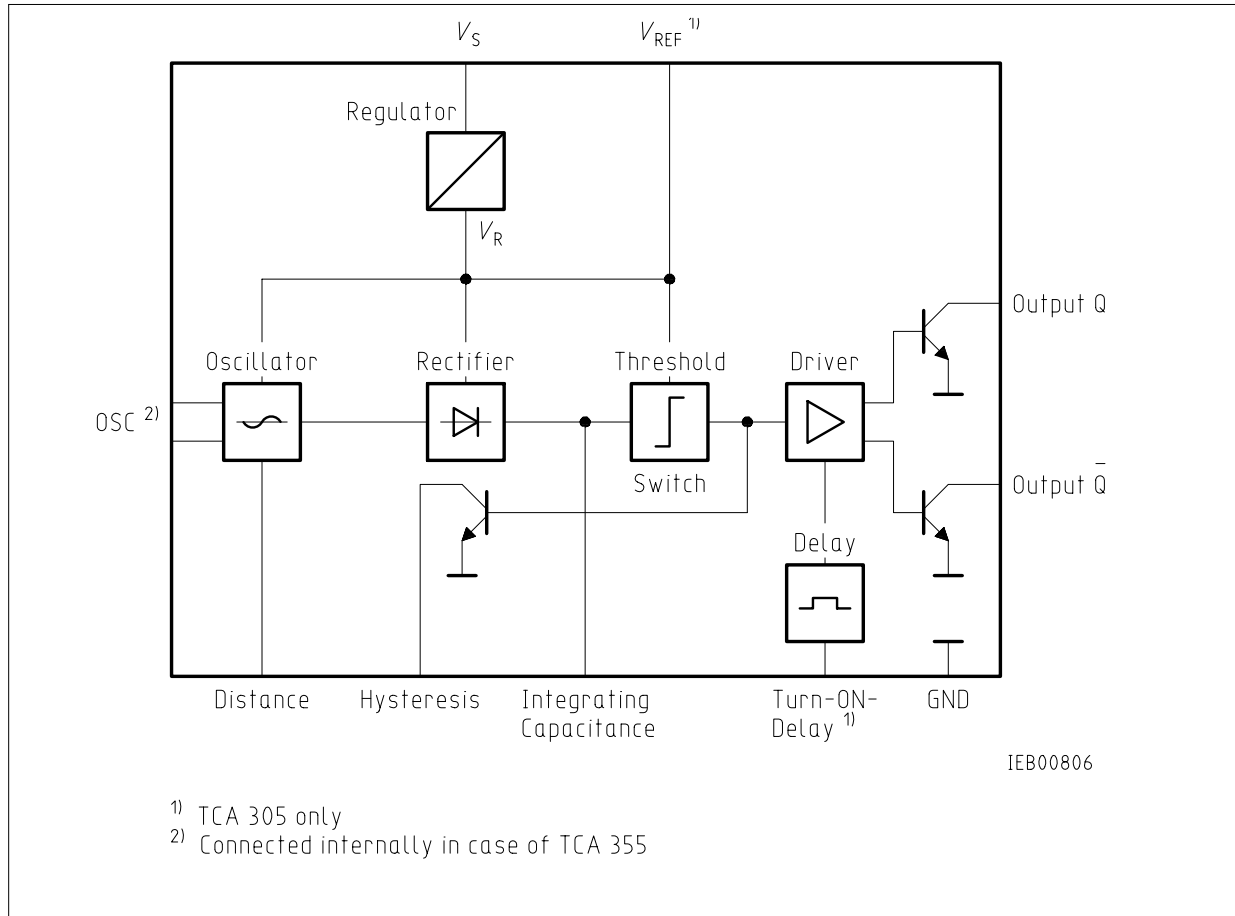

Block Diagram

Standard Turn-ON Delay Referred to $T_A = 25\text{ }^\circ\text{C}$

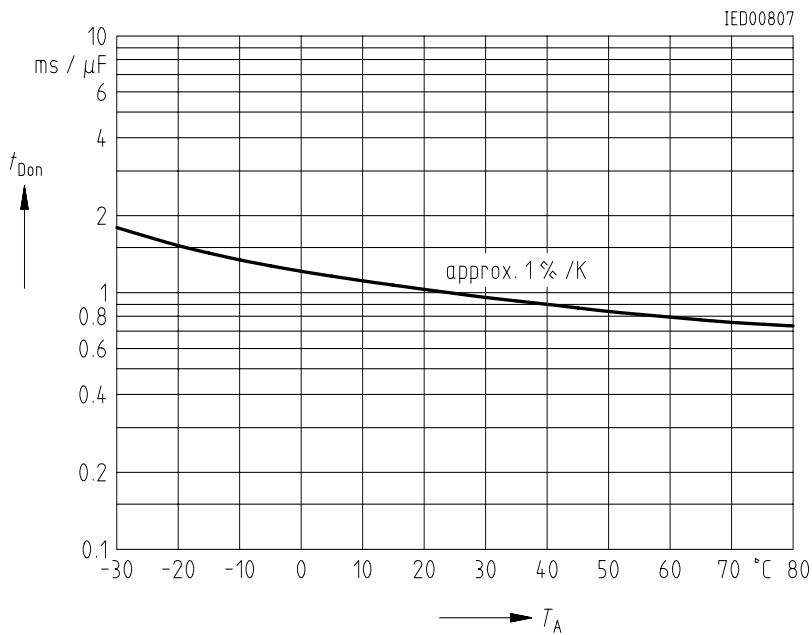

Absolute Maximum Ratings

Parameter	Symbol	Limit Values	Unit
Supply voltage	V_S	35	V
Output voltage	V_Q	35	V
Output current	I_Q	50	mA
Distance, hysteresis resistance	R_{Di}, R_{Hy}	0	Ω
Capacitances	C_I, C_D	5	μF
Junction temperature	T_j	150	$^{\circ}C$
Storage temperature range	T_{stg}	- 55 to 125	$^{\circ}C$
Thermal resistance system - air	$R_{th SA}$	85 (135) ²⁾	K/W
TCA 305 A TCA 305 G	$R_{th SA}$	140 (200) ²⁾	K/W

Operating Range

Supply voltage	V_S	5 to 30 ³⁾	V
Oscillator frequency	f_{osc}	0.015 to 1.5	MHz
Ambient temperature	T_A	- 25 to 85	$^{\circ}C$

Characteristics

$V_S = 12 V, T_A = - 25 \text{ to } 85 \text{ }^{\circ}C$

Parameter	Symbol	Limit Values			Unit	Test Condition
		min.	typ.	max.		
Open-loop current consumption	I_S		0.6	0.9 (1.0) ²⁾	mA	outputs open
Reference voltage ¹⁾	V_{REF}		3.2		V	$I_{REF} < 10 \mu A$
L-output voltage per output	V_{QL}		0.04	0.15	V	$I_{QL} = 5 \text{ mA}$
	V_{QL}		0.10	0.35	V	$I_{QL} = 25 \text{ mA}$
	V_{QL}		0.22	0.75	V	$I_{QL} = 50 \text{ mA}$
H-output current per output	I_{QH}			10	μA	$V_{QH} = 30 V$
Threshold at 3	V_{S3}		2.1		V	
Hysteresis at 3	V_{Hy}	0.4	0.5	0.6	V	
Turn-ON delay ¹⁾	$t_{D ON}$	- 25 %	600	- 25 %	ms/ μF	$T_A = 25 \text{ }^{\circ}C$
Switching frequency w/o C_I	f_s			5	kHz	

1) TCA 305 only

2) Values in parenthesis apply to TCA 355 only

3) Operation at voltages less than 5 V (between approx. 2.5 and 5 V) is possible, if V_{REF} is connected to V_S . In this case V_{REF} is no longer internally stabilized. Additionally, the pin "turn-on delay" is to be applied as follows: If no turn-on delay is needed, this pin has to be connected to V_S . If, however, a turn-on delay is required, the charge current for D_D has to be adjusted with an external resistor between this pin and V_S (recommended value 390 k Ω).

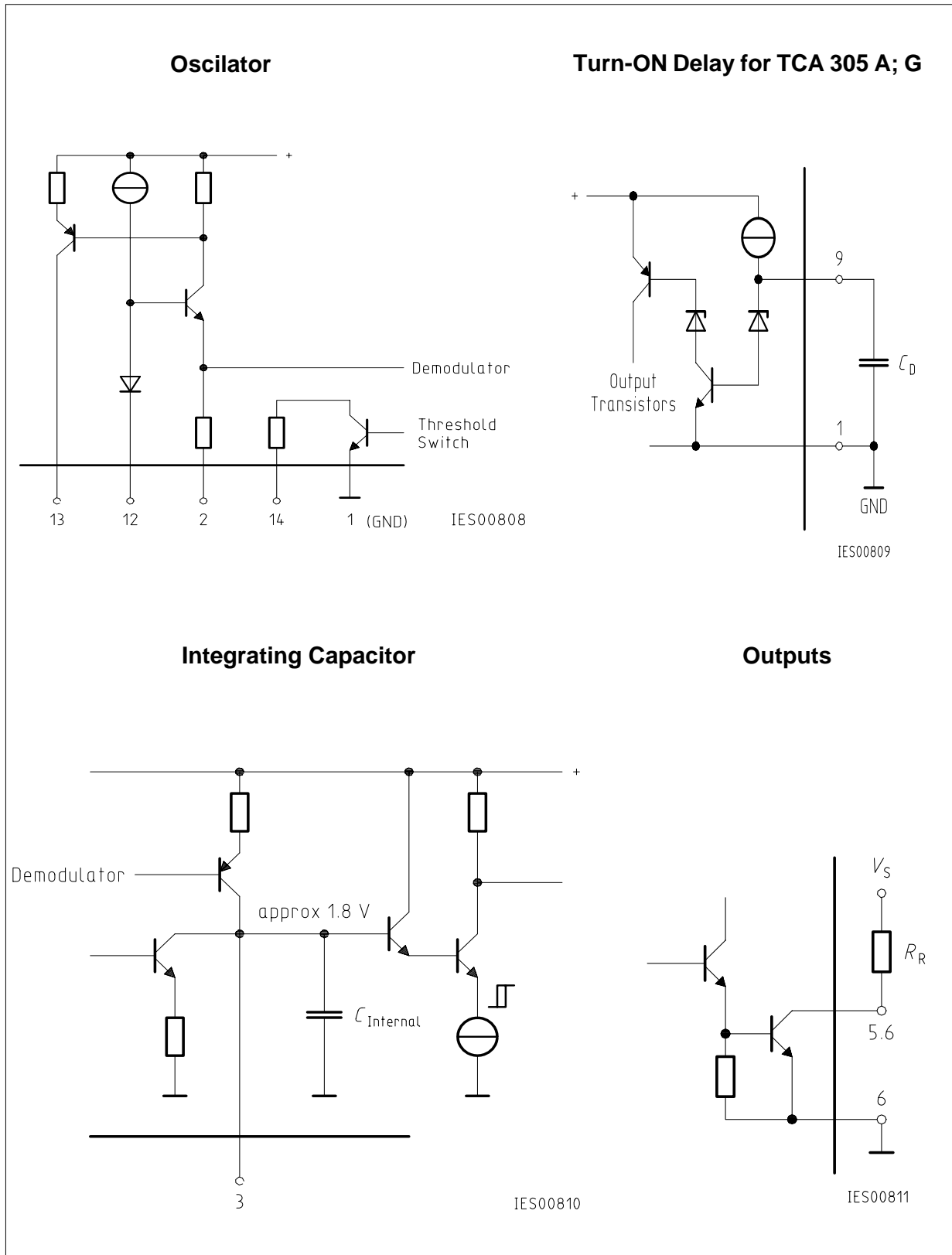

Schematic Circuit Diagram

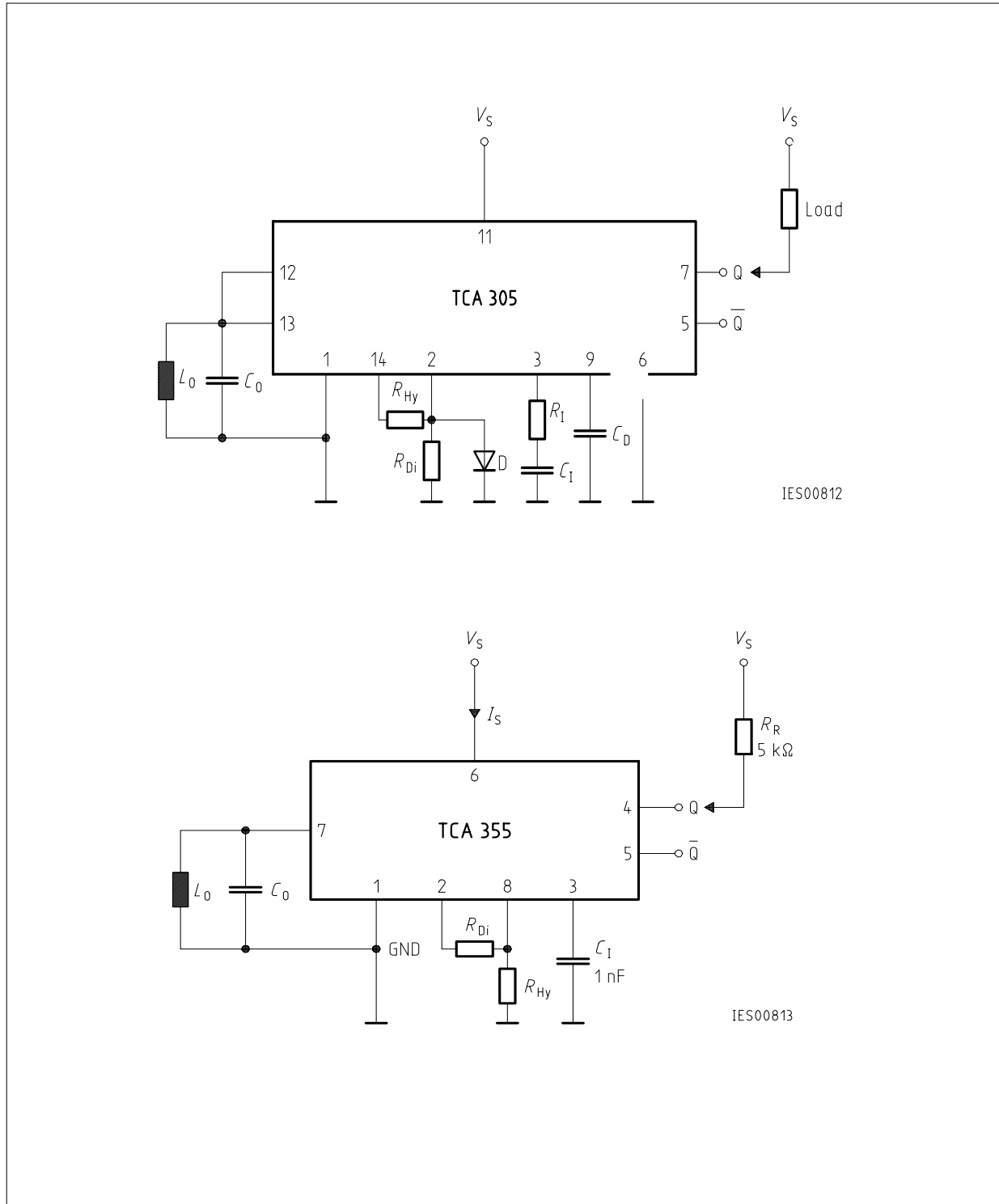

IES00812

IES00813

Application Circuit

L_0, C_0	Resonant circuit
R_{Hy}	Hysteresis adjustment
R_{Di}	Distance adjustment
D	Temperature compensation of the resonant circuit; possibly with series resistance for the purpose of adjustment. The diode is not absolutely necessary. Whether it is used or not depends on the temperature coefficient of the resonant circuit.
$R_I; C_I$	Integration element. At pin 3 (integrating capacitance) we recommend a capacitor of typ. 1 nF. To increase noise immunity this capacitor can be substituted by an RC circuit with, e.g., $R_I = 1 M^{\Omega}$ and $C_I = 10$ nF.
C_D	Delay capacitor

Dimensioning Examples in Accordance with CENELEC Standard (flush)

	M 12	M 18	M 30
Ferrite pot core	M 33 (7.35 × 3.6) mm	N 22 (14.4 × 7.5) mm	N 22 (25 × 8.9) mm
Number of turns	100	80	100
Cross section of wire	0.1 CuL	20 × 0.05	10 × 0.1
L_0	206 μ H	268 μ H	585 μ H
C_0 (STYROFLEX®)	1000 pF	1.2 nF	3.3 nF
f_{sc}	appr. 350 kHz	appr. 280 kHz	appr. 115 kHz
Sn	4 mm	8 mm	15 mm
R_A (Metal)	8.2 k $^{\Omega}$ + 330 $^{\Omega}$	33 k $^{\Omega}$	22 k $^{\Omega}$ + 2.7 k $^{\Omega}$
C_D	100 nF	100 nF	100 nF