

2 mode Noise Filters

Type: **EXC24CB/CP**
EXC24CN



■ Features

- Burst/radiation noise filtering for audio circuits
- The optimally magnetic-coupled ferrite beads allow for the filtering of both common and normal mode noises
- The strong multi-layer structure provides high resistance to reflow soldering heat and a high mounting reliability
- Magnetic shield type
- High Impedance : 220 to 1 k Ω (EXC24CB type)
- Low Resistance Value : 0.4 Ω max. (EXC24CP type)
- High Impedance : 600 Ω ,
Low Resistance Value : 0.9 Ω max. (EXC24CN type)

■ Recommended Applications

- Receiver lines, speaker lines, microphone lines and headset of mobile phones.
- Audio signal lines of Portable audio equipment, PCs, PDAs.

■ Explanation of Part Numbers

● EXC24CB/CP Type

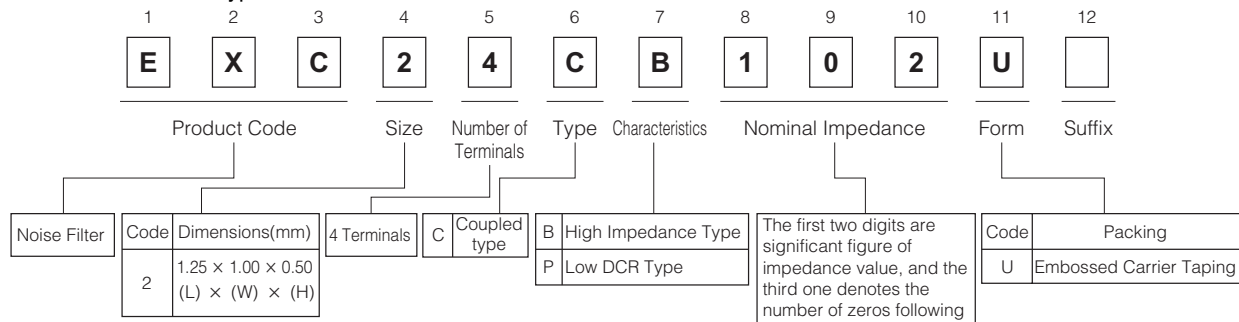

● EXC24CN Type

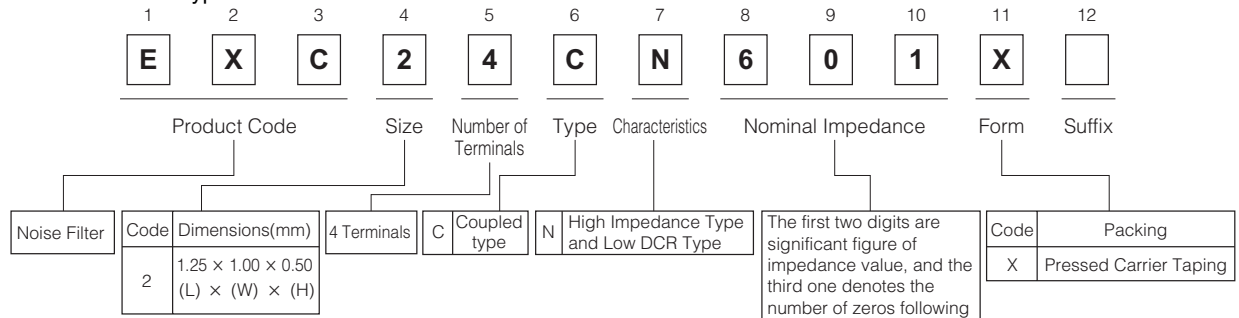

■ Construction

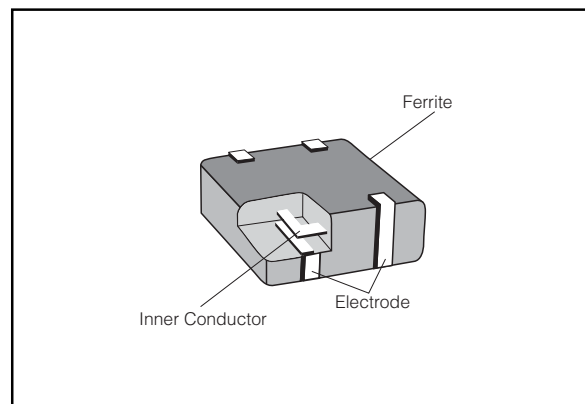

■ Dimensions in mm (not to scale)

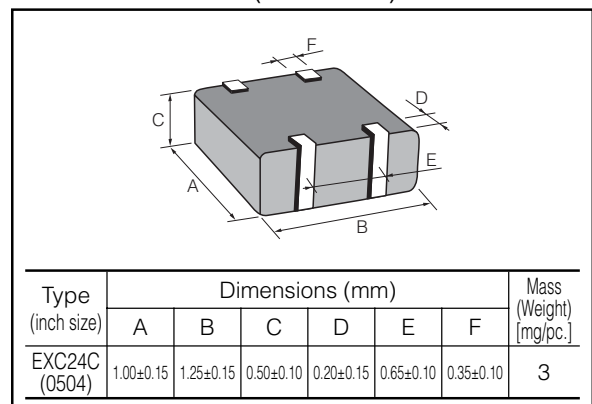

Design and specifications are each subject to change without notice. Ask factory for the current technical specifications before purchase and/or use.
Should a safety concern arise regarding this product, please be sure to contact us immediately.

00 Sep. 2010

■ Circuit Configuration (No Polarity)

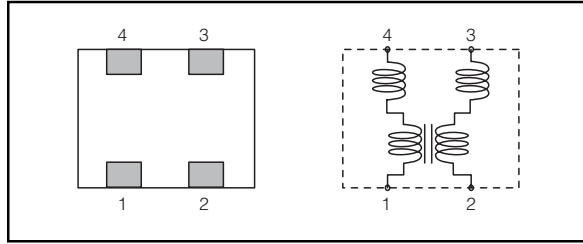

■ Ratings

Part Number	Impedance (Open mode)		Rated Voltage (V DC)	Rated Current (mA DC)	DC Resistance (Ω) max.
	(Ω) at 100MHz	Tolerance(%)			
EXC24CP121U	120	± 25	5	500	0.3
EXC24CP221U	220			350	0.4
EXC24CB221U	220			100	0.7
EXC24CB102U	1000			50	1.5

Part Number	Impedance (Common mode)		Rated Voltage (V DC)	Rated Current (mA DC)	DC Resistance (Ω) max.
	(Ω) at 100MHz	Tolerance(%)			
EXC24CN601X	600	± 25	5	200	0.9

■ Impedance Characteristics (Typical)

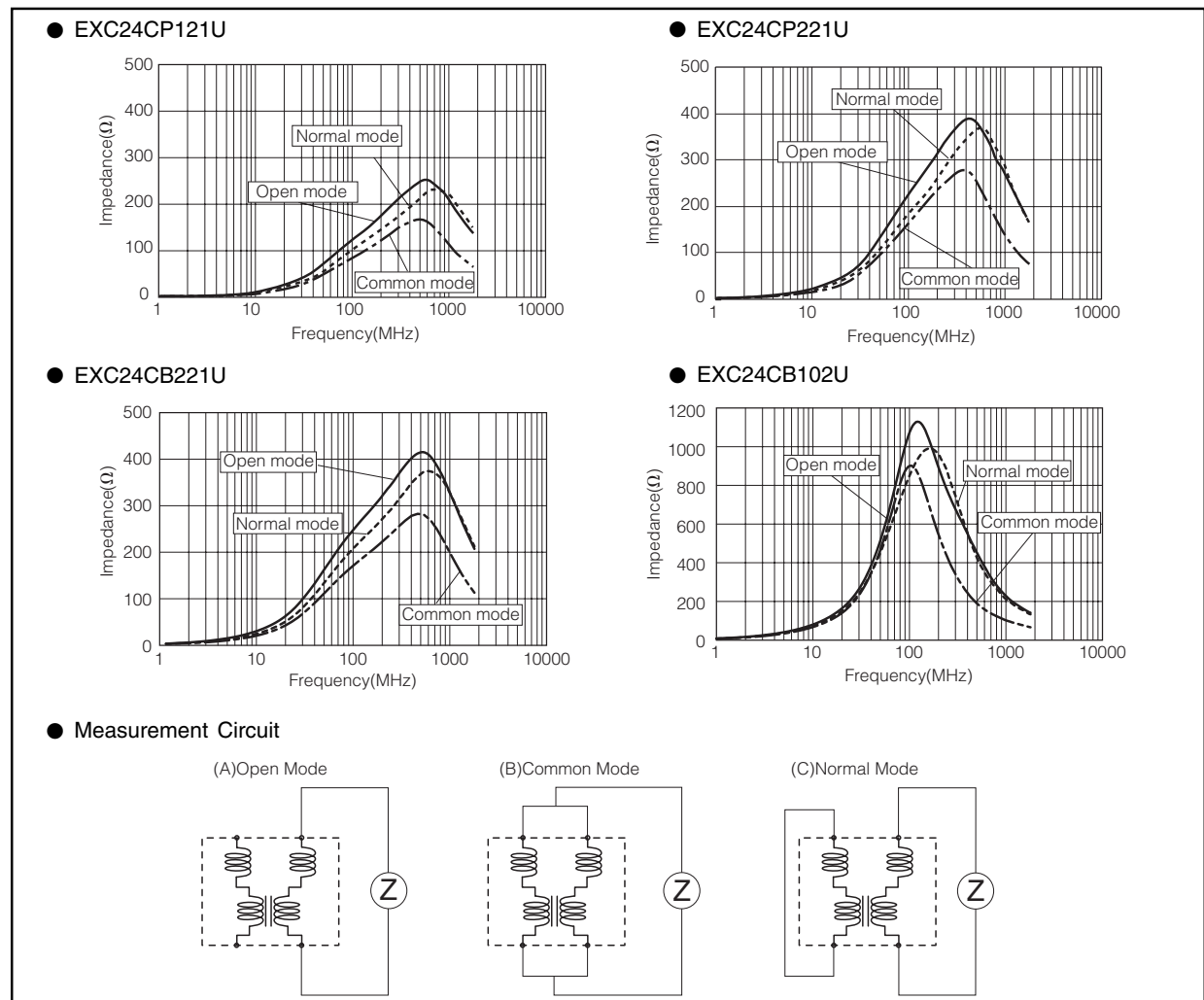

Design and specifications are each subject to change without notice. Ask factory for the current technical specifications before purchase and/or use. Should a safety concern arise regarding this product, please be sure to contact us immediately.

00 Sep. 2010

Impedance Characteristics (Typical)

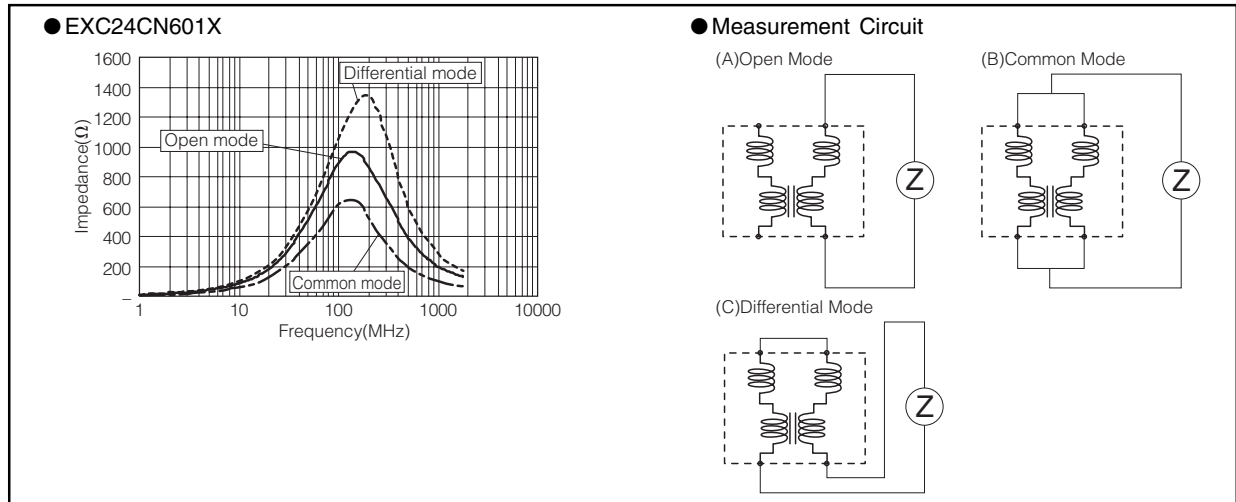

Packaging Methods (Taping)

● Standard Quantity

Part Number	Kind of Taping	Pitch (P ₁)	Quantity
EXC24CP□□□□U	Embossed Carrier Taping	4 mm	5000 pcs./reel
EXC24CB□□□□U			
EXC24CN□□□□X	Pressed Carrier Taping	2 mm	10000 pcs./reel

Embossed Carrier Taping

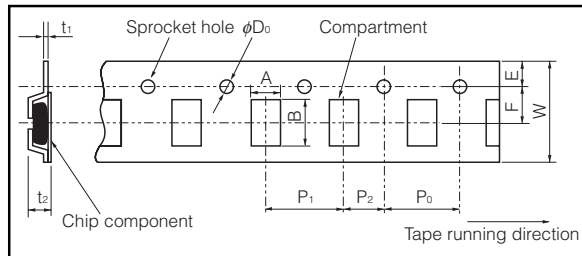

Pressed Carrier Taping

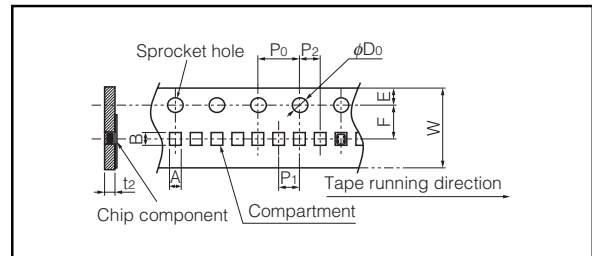

Taping Reel

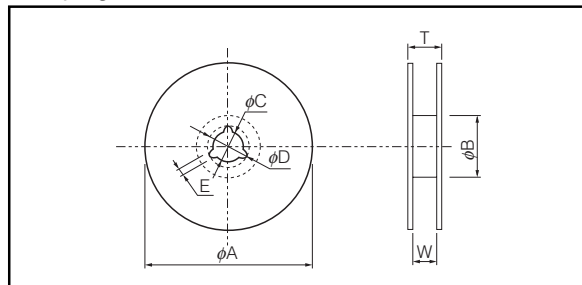

Embossed Carrier Dimensions (mm)

Part Number	A	B	W	F	E	P ₁	P ₂	P ₀	φD ₀	t ₁	t ₂
EXC24CP□□□□U	1.20±0.15	1.45±0.15	8.0±0.2	3.5±0.1	1.75±0.10	4.0±0.1	2.0±0.1	4.0±0.1	1.5±0.1	0.25±0.05	0.90±0.15
EXC24CB□□□□U											

Pressed Carrier Dimensions (mm)

Part Number	A	B	W	F	E	P ₁	P ₂	P ₀	φD ₀	t ₂
EXC24CN□□□□X	1.14±0.10	1.38±0.15	8.0±0.2	3.5±0.1	1.75±0.10	2.0±0.1	2.0±0.1	4.0±0.1	1.5±0.1	0.68±0.10

Standard Reel Dimensions (mm)

Part Number	φA	φB	φC	φD	E	W	T
EXC24C□□□□□	180.0±3.0	60.0±1.0	13.0±0.5	21.0±0.8	2.0±0.5	9.0±0.3	11.4±1.5

Design and specifications are each subject to change without notice. Ask factory for the current technical specifications before purchase and/or use. Should a safety concern arise regarding this product, please be sure to contact us immediately.

00 Sep. 2010

Recommended Land Pattern Design

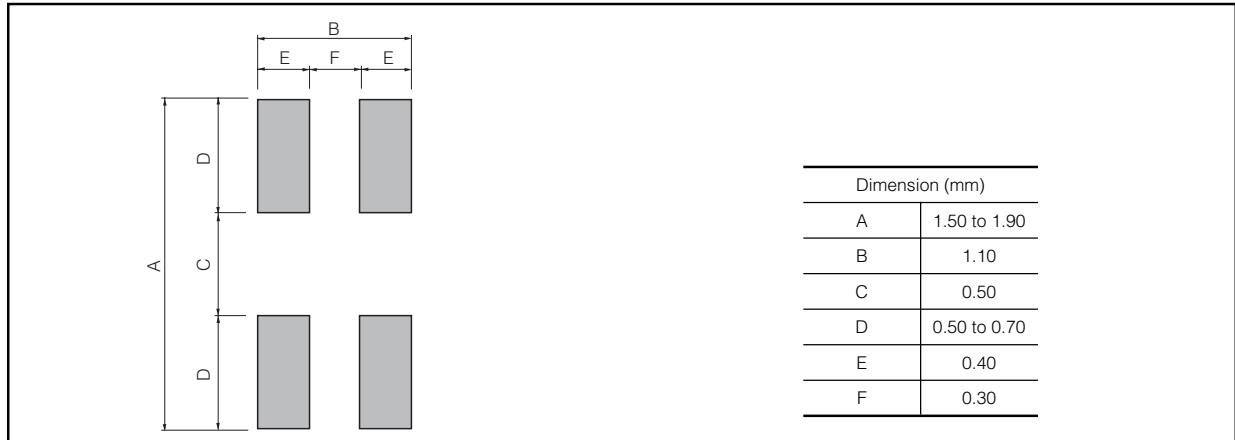

Recommended Soldering Conditions

Recommendations and precautions are described below.

Recommended soldering conditions for reflow

- Reflow soldering shall be performed a maximum of two times.
- Please contact us for additional information when used in conditions other than those specified.
- Please measure the temperature of the terminals and study every kind of solder and printed circuit board for solderability before actual use.

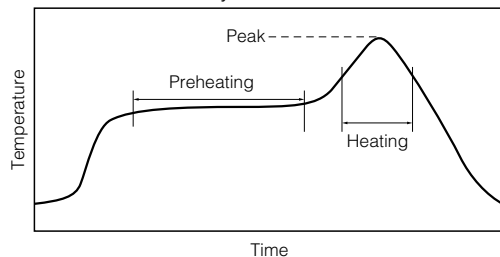

For soldering (Example : Sn-37Pb)

	Temperature	Time
Preheating	140 °C to 160 °C	60 s to 120 s
Main heating	Above 200 °C	30 s to 40 s
Peak	235 ± 10 °C	max. 10 s

For lead-free soldering (Example : Sn/3Ag/0.5Cu)

	Temperature	Time
Preheating	150 °C to 170 °C	60 s to 120 s
Main heating	Above 230 °C	30 s to 40 s
Peak	max. 260 °C	max. 10 s

Flow soldering

- We do not recommend flow soldering , because flow soldering may cause bridges between the electrodes.

<Repair with hand soldering>

- Preheat with a blast of hot air or similar method. Use a soldering iron with a tip temperature of 350 °C or less. Solder each electrode for 3 seconds or less.
- Never touch this product with the tip of a soldering iron.

⚠ Safety Precautions

The following are precautions for individual products. Please also refer to the common precautions shown on page 4 of this catalog.

1. Use rosin-based flux or halogen-free flux.
2. For cleaning, use an alcohol-based cleaning agent. Before using any other type, consult with our sales person in advance.
3. Do not apply shock to 2 mode Noise Filters (hereafter called the filters) or pinch them with a hard tool (e.g. pliers and tweezers). Otherwise, their bodies may be chipped, affecting their performance. Excessive mechanical stress may damage the filters. Handle with care.
4. Store the filters in a location with a temperature ranging from -5 °C to +40 °C and a relative humidity of 40 % to 60 %, where there are no rapid changes in temperature or humidity.
5. Use the filters within half a year after the date of the outgoing inspection indicated on the packages.