



CYPRESS

FastEdge™ Series
CY2PP3220

Dual 1:10 Differential Clock/Data Fanout Buffer

Features

- Two sets of ten ECL/PECL differential outputs
- Two ECL/PECL differential inputs
- Hot-swappable/-insertable
- 50 ps output-to-output skew
- 150 ps device-to-device skew
- 500 ps propagation delay (typical)
- 1.5 GHz Operation (2.7 GHz max. toggle frequency)
- PECL mode supply range: $V_{CC} = 2.5V \pm 5\%$ to $3.3V \pm 5\%$ with $V_{EE} = 0V$
- ECL mode supply range: $V_{EE} = -2.5V \pm 5\%$ to $-3.3V \pm 5\%$ with $V_{CC} = 0V$
- Industrial temperature range: $-40^{\circ}C$ to $85^{\circ}C$
- 52-pin 1.4-mm TQFP package
- Temperature compensation like 100K ECL
- Pin compatible with MC100ES6220

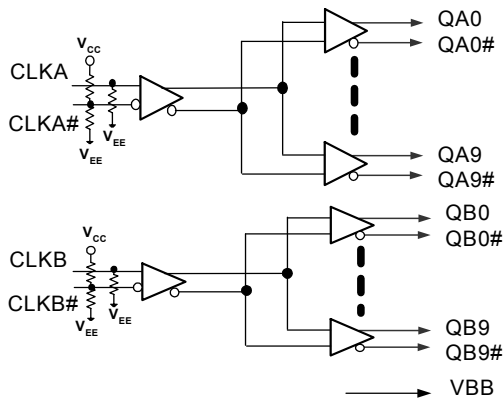
Functional Description

The CY2PP3220 is a low-skew, low propagation delay dual 1-to-10 differential fanout buffer targeted to meet the requirements of high-performance clock and data distribution applications. The device is implemented on SiGe technology and has a fully differential internal architecture that is optimized to achieve low signal skews at operating frequencies of up to 1.5 GHz.

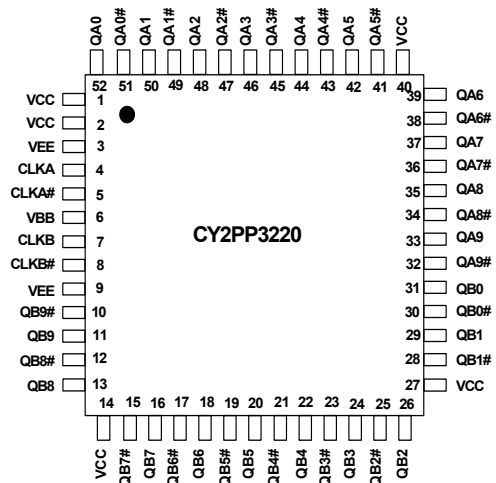
The device features two differential input paths that are differential internally. The CY2PP3220 may function not only as a differential clock buffer but also as a signal-level translator and fanout on ECL/PECL signal to twenty ECL/PECL differential loads. An external bias pin, VBB, is provided for this purpose. In such an application, the VBB pin should be connected to either one of the CLKA# or CLKB# inputs and bypassed to ground via a 0.01- μF capacitor. Traditionally, in ECL, it is used to provide the reference level to a receiving single-ended input that might have a different self-bias point.

Since the CY2PP3220 introduces negligible jitter to the timing budget, it is the ideal choice for distributing high frequency, high precision clocks across back-planes and boards in communication systems. Furthermore, advanced circuit design schemes, such as internal temperature compensation, ensure that the CY2PP3220 delivers consistent performance over various platforms.

Block Diagram



Pin Configuration



Pin Definitions^[1, 2, 3]

Pin	Name	I/O	Type	Description
4	CLKA,	I,PD	ECL/PECL	ECL/PECL Differential input clocks
5	CLKA#	I,PD/PU	ECL/PECL	ECL/PECL Differential input clocks
6	VBB ^[3]	O	Bias	Reference Voltage Output
7	CLKB,	I,PD	ECL/PECL	ECL/PECL Differential input clocks
8	CLKB#	I,PD/PU	ECL/PECL	ECL/PECL Differential input clocks
3,9	VEE ^[2]	-PWR	Power	Negative Supply
1,2,14,27,40	VCC	+PWR	Power	Positive Supply
52,50,48,46,44,42,39,37, 35,33	QA(0:9)	O	ECL/PECL	True output
51,49,47,45,43,41,38,36, 34,32	QA#(0:9)	O	ECL/PECL	Complement output
31,29,26,24,22,20,18,16, 13,11	QB(0:9)	O	ECL/PECL	True output
30,28,25,23,21,19,17,15, 12,10	QB#(0:9)	O	ECL/PECL	Complement output

Governing Agencies

The following agencies provide specifications that apply to the CY2PP3220. The agency name and relevant specification is listed below in *Table 1*.

Table 1.

Agency Name	Specification
JEDEC	JESD 020B (MSL) JESD 51 (Theta JA) JESD 8-2 (ECL) JESD 65-B (skew,jitter)
Mil-Spec	883E Method 1012.1 (Thermal Theta JC)

Notes:

- In the I/O column, the following notation is used: I for Input, O for Output, PD for Pull-Down, PU for Pull-Up, and PWR for Power
- In ECL mode (negative power supply mode), V_{EE} is either -3.3V or -2.5V and V_{CC} is connected to GND (0V). In PECL mode (positive power supply mode), V_{EE} is connected to GND (0V) and V_{CC} is either +3.3V or +2.5V. In both modes, the input and output levels are referenced to the most positive supply (V_{CC}) and are between V_{CC} and V_{EE}.
- V_{BB} is available for use for single-ended bias mode for |3.3V| supplies (not |2.5V|).

Absolute Maximum Ratings

Parameter	Description	Condition	Min.	Max.	Unit
V _{CC}	Positive Supply Voltage	Non-Functional	-0.3	4.6	V
V _{EE}	Negative Supply Voltage	Non-Functional	-4.6	0.3	V
T _S	Temperature, Storage	Non-Functional	-65	+150	°C
T _J	Temperature, Junction	Non-Functional		150	°C
ESD _h	ESD Protection	Human Body Model		2000	V
M _{SL}	Moisture Sensitivity Level			3	N.A.
Gate Count	Total Number of Used Gates	Assembled Die		50	gates

Multiple Supplies: The Voltage on any input or I/O pin cannot exceed the power pin during power-up. Power supply sequencing is NOT required.

Operating Conditions

Parameter	Description	Condition	Min.	Max.	Unit
I _{BB}	Output Reference Current	Relative to V _{BB}	-	200	uA
LU _I	Latch Up Immunity	Functional, typical		100	mA
T _A	Temperature, Operating Ambient	Functional	-40	+85	°C
∅ _{Jc}	Dissipation, Junction to Case	Functional		22 ^[4]	°C/W
∅ _{Ja}	Dissipation, Junction to Ambient	Functional		60 ^[4]	°C/W
I _{EE}	Maximum Quiescent Supply Current	V _{EE} pin ^[5]		250	mA
C _{IN}	Input pin capacitance		-	3	pF
L _{IN}	Pin Inductance		-	1	nH
V _{IN}	Input Voltage	Relative to V _{CC} ^[6]	-0.3	V _{CC} + 0.3	V
V _{TT}	Output Termination Voltage	Relative to V _{CC} ^[6]		V _{CC} - 2	V
V _{OUT}	Output Voltage	Relative to V _{CC} ^[6]	-0.3	V _{CC} + 0.3	V
I _{IN}	Input Current ^[7]	V _{IN} = V _{IL} , or V _{IN} = V _{IH}		150	uA

PECL DC Electrical Specifications

Parameter	Description	Condition	Min.	Max.	Unit
V _{CC}	Operating Voltage	2.5V ± 5%, V _{EE} = 0.0V 3.3V ± 5%, V _{EE} = 0.0V	2.375 3.135	2.625 3.465	V V
V _{CMR}	Differential Cross Point Voltage ^[8]	Differential operation	1.2	V _{CC}	V
V _{OH}	Output High Voltage	I _{OH} = -30 mA ^[9]	V _{CC} - 1.25	V _{CC} - 0.7	V
V _{OL}	Output Low Voltage V _{CC} = 3.3V ± 5% V _{CC} = 2.5V ± 5%	I _{OL} = -5 mA ^[9]	V _{CC} - 1.995 V _{CC} - 1.995	V _{CC} - 1.5 V _{CC} - 1.3	V V
V _{IH}	Input Voltage, High	Single-ended operation	V _{CC} - 1.165	V _{CC} - 0.880 ^[10]	V
V _{IL}	Input Voltage, Low	Single-ended operation	V _{CC} - 1.945 ^[10]	V _{CC} - 1.625	V
V _{BB} ^[3]	Output Reference Voltage	Relative to V _{CC} ^[6]	V _{CC} - 1.620	V _{CC} - 1.220	V

Notes:

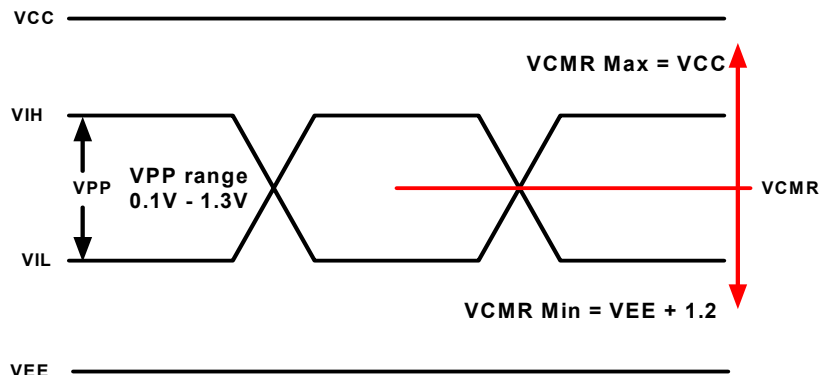
4. Theta JA EIA JEDEC 51 test board conditions (typical value); Theta JC 883E Method 1012.1
5. Power Calculation: V_{CC} * I_{EE} + 0.5 (I_{OH} + I_{OL}) (V_{OH} - V_{OL}) (number of differential outputs used); I_{EE} does not include current going off chip.
6. where V_{CC} is 3.3V±5% or 2.5V±5%
7. Inputs have internal pull-up/pull-down or biasing resistors which affect the input current.
8. Refer to Figure 1
9. Equivalent to a termination of 50Ω to V_{TT}. I_{OHMIN}=(V_{OHMIN}-V_{TT})/50; I_{OHMAX}=(V_{OHMAX}-V_{TT})/50; I_{OLMIN}=(V_{OLMIN}-V_{TT})/50; I_{OLMAX}=(V_{OLMAX}-V_{TT})/50;
10. V_{IL} will operate down to V_{EE}; V_{IH} will operate up to V_{CC}

ECL DC Electrical Specifications

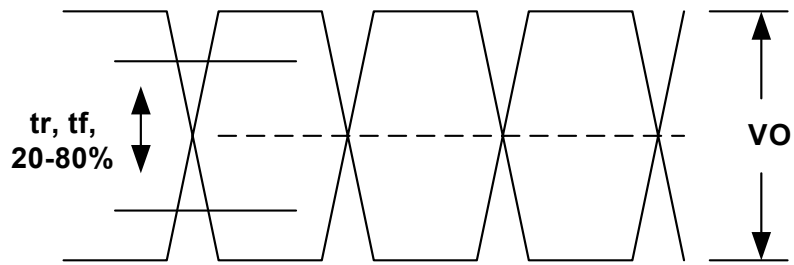
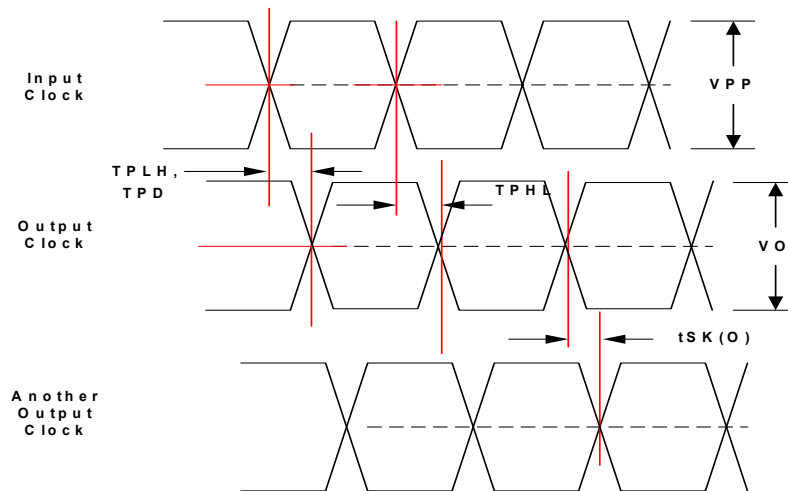
Parameter	Description	Condition	Min.	Max.	Unit
V_{EE}	Negative Power Supply	$-2.5V \pm 5\%$, $V_{CC} = 0.0V$ $-3.3V \pm 5\%$, $V_{CC} = 0.0V$	-2.625 -3.465	-2.375 -3.135	V
V_{CMR}	Differential cross point voltage ^[8]	Differential operation	$V_{EE} + 1.2$	0V	V
V_{OH}	Output High Voltage	$I_{OH} = -30\text{ mA}$ ^[9]	-1.25	-0.7	V
V_{OL}	Output Low Voltage $V_{EE} = -3.3V \pm 5\%$ $V_{EE} = -2.5V \pm 5\%$	$I_{OL} = -5\text{ mA}$ ^[9]	-1.995 -1.995	-1.5 -1.3	V
V_{IH}	Input Voltage, High	Single-ended operation	-1.165	-0.880 ^[10]	V
V_{IL}	Input Voltage, Low	Single-ended operation	-1.945 ^[10]	-1.625	V
V_{BB} ^[3]	Output Reference Voltage		-1.620	-1.220	V

AC Electrical Specifications

Parameter	Description	Condition	Min.	Max.	Unit
V_{PP}	Differential Input Voltage ^[8]	Differential operation	0.1	1.3	V
F_{CLK}	Input Frequency	50% duty cycle Standard load		1.5	GHz
T_{PD}	Propagation Delay CLKA or CLKB to Output pair	660 MHz ^[11]	400	750	ps
V_o	Output Voltage (peak-to-peak; see Figure 2)	< 1 GHz	0.375	–	V
V_{CMRO}	Output Common Voltage Range (typ.)		$V_{CC} - 1.425$		V
$tsk_{(0)}$	Output-to-output Skew	660 MHz ^[11] , See Figure 3	–	50	ps
$tsk_{(PP)}$	Part-to-Part Output Skew	660 MHz ^[11]	–	150	ps
T_{PER}	Output Period Jitter (rms) ^[12]	660 MHz ^[11]	–	1.2	ps
$tsk_{(P)}$	Output Pulse Skew ^[13]	660 MHz ^[11] , See Figure 3	–	50	ps
T_{R,T_F}	Output Rise/Fall Time (see Figure 2)	660 MHz 50% duty cycle Differential 20% to 80%	0.08	0.3	ns

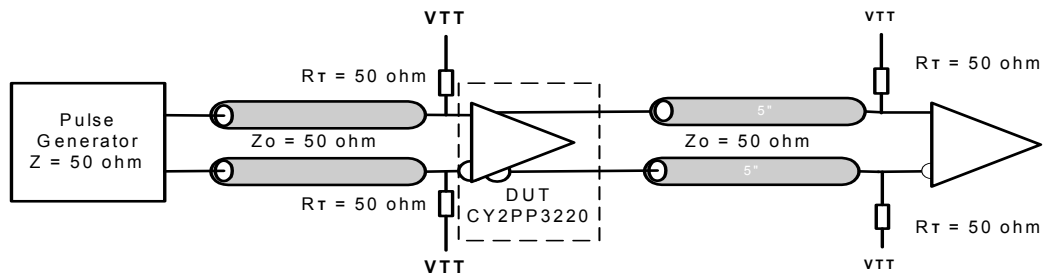
Timing Definitions

Figure 1. PECL/ECL Input Waveform Definitions
Notes:

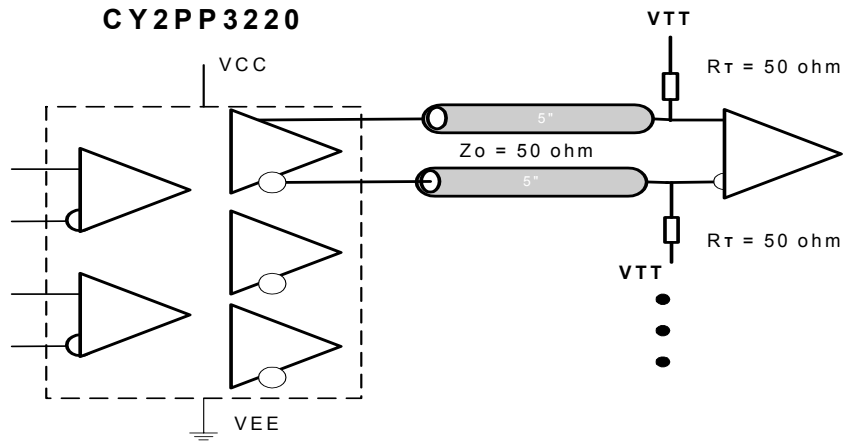
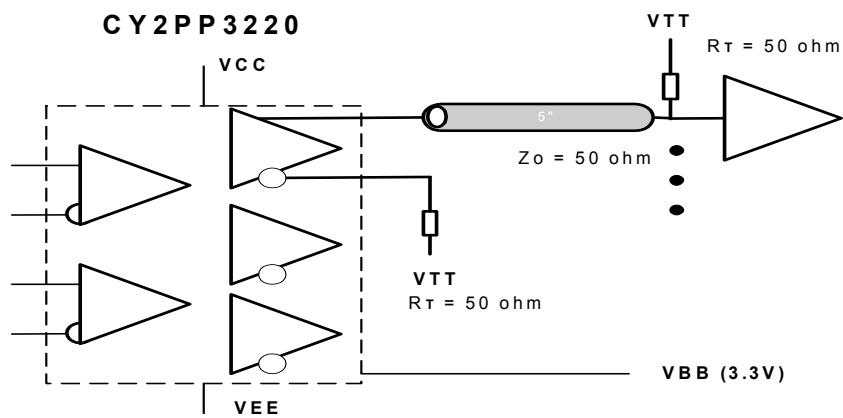
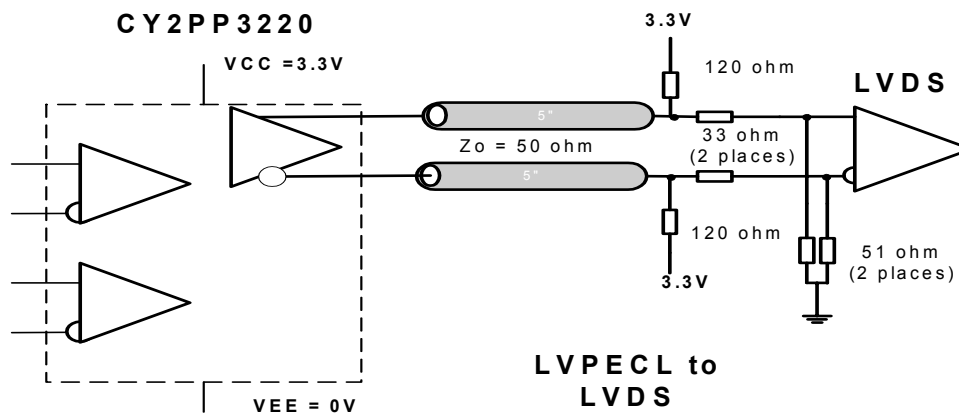
11. 50% duty cycle; standard load; differential operation
12. For 3.3V supplies. Jitter measured differentially using an Agilent 8133A Pulse Generator with an 8500A LeCroy Wavemaster Oscilloscope using at least 10,000 data points
13. Output pulse skew is the absolute difference of the propagation delay times: $|t_{PLH} - t_{PHL}|$.

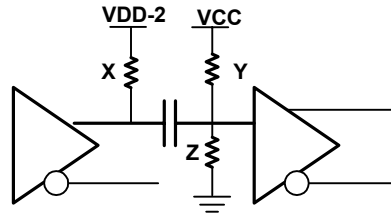

Figure 2. ECL/LVPECL Output

Figure 3. Propagation Delay (T_{PD}), output pulse skew ($|t_{PLH} - t_{PHL}|$), and output-to-output skew ($t_{SK(O)}$) for both CLKA or CLKB to Output Pair, PECL/ECL to PECL/ECL

Test Configuration

Standard test load using a differential pulse generator and differential measurement instrument.


Figure 4. CY2PP3220 AC Test Reference

Applications Information
Termination Examples

Figure 5. Standard LVPECL – PECL Output Termination

Figure 6. Driving a PECL/ECL Single-ended Input

Figure 7. Low-voltage Positive Emitter-coupled Logic (LVPECL) to a Low-voltage Differential Signaling (LVDS) Interface



One output is shown for clarity

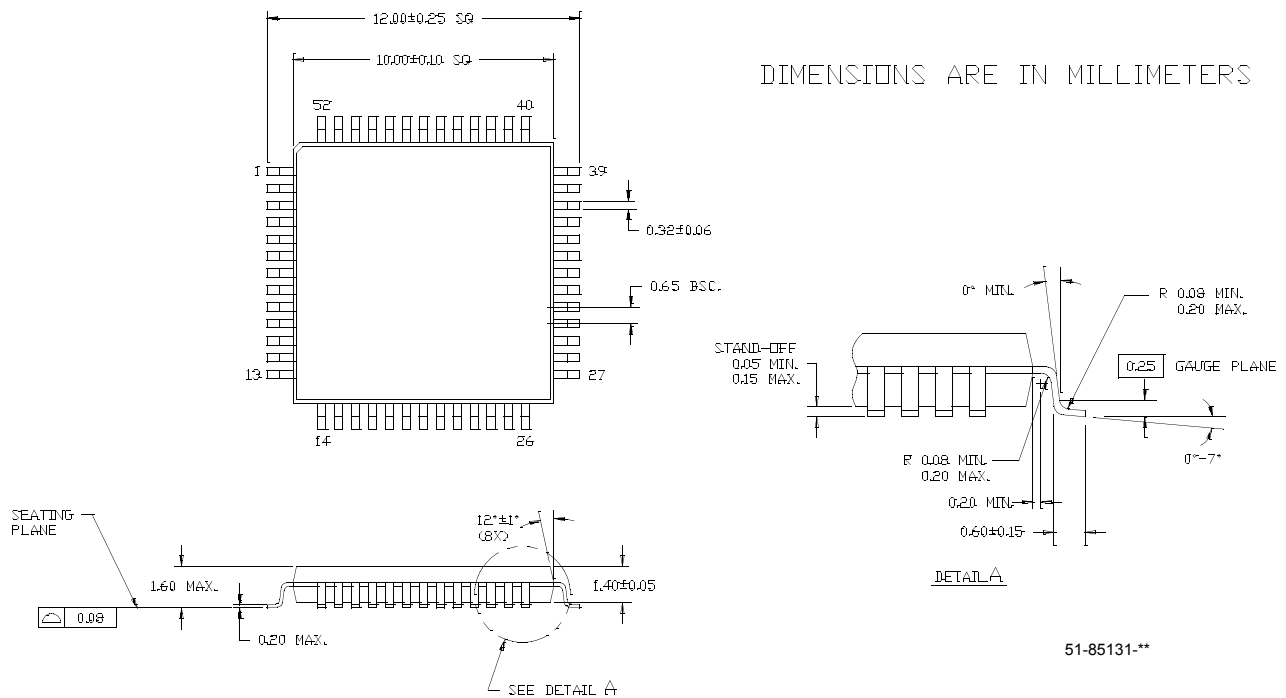
Figure 8. Termination for LVPECL to HTSL interface for VCC=2.5V would use X=50 Ohms, Y=2300 Ohms, and Z=1000 Ohms. See application note titled, “PECL Translation, SAW Oscillators, and Specs” for other signalling standards and supplies.

Ordering Information

Part Number	Package Type	Product Flow
CY2PP3220AI	52-pin TQFP	Industrial, -40° to 85°C
CY2PP3220AIT	52-pin TQFP – Tape and Reel	Industrial, -40° to 85°C

Package Drawing and Dimensions

52-lead Thin Plastic Quad Flat Pack (10 x 10 x 1.4 mm) A52



FastEdge is a trademark of Cypress Semiconductor. All product and company names mentioned in this document are the trademarks of their respective holders.

Document History Page

Document Title: CY2PP3220 FastEdge™ Series Dual 1:10 Differential Clock/Data Fanout Buffer				
Document Number: 38-07513				
REV.	ECN NO.	Issue Date	Orig. of Change	Description of Change
**	122437	02/13/03	RGL	New Data Sheet
*A	125459	04/16/03	RGL	Interchanged Pin 30 and 31 from QB0 /QB0# to QB0#/QB0 Changed the title to FastEdge™ Series Dual 1:10 Differential Clock/Data Fanout Buffer
*B	229372	See ECN	RGL	Supplied data to all TBD's to match the device.
*C	247613	See ECN	RGL/GGK	Changed V _{OH} and V _{OL} to match the Char Data