

## J-FET INPUT OPERATIONAL AMPLIFIER

### ■ GENERAL DESCRIPTION

The NJM062/064 are J-FET input operational amplifiers which were designed as low-power versions of the NJM082. They feature high input impedance, wide bandwidth, high slew rate, and low input offset and bias current.

The NJM062 features the same terminal assignments as the NJM4558/2043/2904/3404/072 and NJM064 features the same terminal assignments as the NJM2902/3403/2058/2059/2060.

Each of these JFET-input operational amplifiers incorporates well-matched, high voltage JFET and bipolar transistors in a monolithic integrated circuit.

### ■ FEATURES

- Operating Voltage (  $\pm 2V \sim \pm 18V$  )
- J-FET Input
- High Input Resistance (  $10^{12}\Omega$  typ. )
- Low Operating Current (  $200\mu A/circuit$  typ. )
- High Slew Rate (  $3.5V/\mu s$  typ. )
- Wide Unity Gain Bandwidth ( 1MHz typ. )
- Package Outline DIP8/14, DMP8/14, SSOP8/14, SIP8
- Bipolar Technology

### ■ PACKAGE OUTLINE

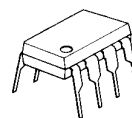

NJM062D

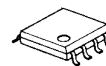

NJM062M

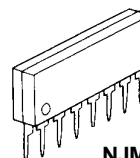

NJM062L



NJM062V

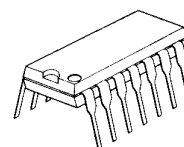

NJM064D

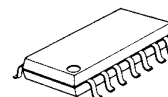

NJM064M



NJM064V

### ■ PIN CONFIGURATION

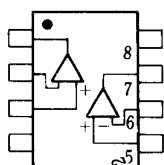

NJM062D  
NJM062M  
NJM062V

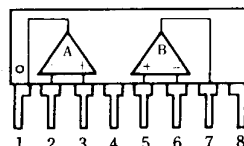

NJM062L

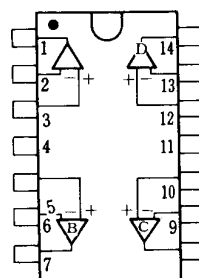

NJM064D  
NJM064M  
NJM064V

### PIN FUNCTION

1. A OUTPUT
2. A -INPUT
3. A +INPUT
4.  $V^+$
5. B +INPUT
6. B -INPUT
7. B OUTPUT
8. C OUTPUT
9. C -INPUT
10. C +INPUT
11.  $V^-$
12. D +INPUT
13. D -INPUT
14. D OUTPUT

### PIN FUNCTION

1. A OUTPUT
2. A -INPUT
3. A +INPUT
4.  $V^+$
5. B +INPUT
6. B -INPUT
7. B OUTPUT
8.  $V^+$

# NJM062/064

■ EQUIVALENT CIRCUIT (062 is 1/2 Shown.064 is 1/4 Shown.)

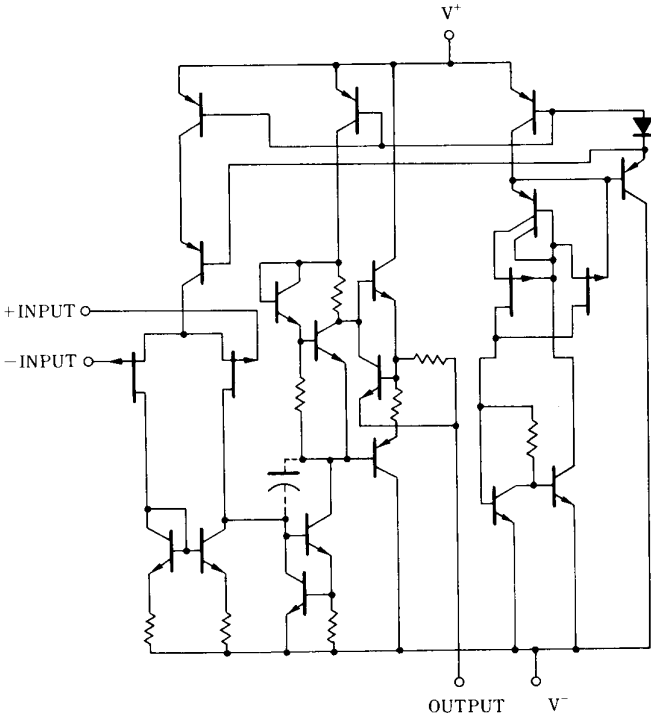

## ■ ABSOLUTE MAXIMUM RATINGS

(Ta=25°C)

PARAMETER	SYMBOL	RATINGS	UNIT
Supply Voltage	$V^+V^-$	± 18	V
Differential Input Voltage	$V_{ID}$	± 30	V
Input Voltage	$V_{IC}$	± 15	V
Power Dissipation	$P_D$	(DIP8) 500 (DMP8) 300 (SIP8) 800 (SSOP8) 250 (DIP14) 700 (DMP14) 700 (note2) (SSOP14) 300	mW
Operating Temperature Range	$T_{opr}$	-40~+85	°C
Storage Temperature Range	$T_{stg}$	-40~+125	°C

(note1) For supply voltage less than ±15V. The absolute maximum input voltage is equal to the supply voltage.

(note2) At on PC board

## ■ ELECTRICAL CHARACTERISTICS

( $V^+V^-=\pm 15V, Ta=25^\circ C$ )

PARAMETER	SYMBOL	TEST CONDITION	MIN.	TYP.	MAX.	UNIT
Operating Supply Voltage	$V^+V^-$		± 2	-	± 18	V
Input Offset Voltage	$V_{IO}$	$R_S=50\Omega$	-	3	15	mV
Input Offset Current	$I_{IO}$		-	1	200	pA
Input Bias Current	$I_B$		-	2	400	pA
Input Common Mode Voltage Range	$V_{ICM}$		± 13	+15 -13.5	-	V
Maximum Peak-to-peak Output Voltage Swing	$V_{OM}$	$R_L=10k\Omega$	± 13	+14.2 -14.0	-	V
Large-signal Voltage Gain	$A_V$	$R_L \geq 10k\Omega, V_O = \pm 10V$	70	80	-	dB
Unity Gain Bandwidth	$f_T$	$R_L=10k\Omega$	-	1	-	MHz
Input Resistance	$R_{IN}$		-	$10^{12}$	-	$\Omega$
Common Mode Rejection Ratio	CMR	$R_S \leq 10k\Omega$	70	90	-	dB
Supply Voltage Rejection Ratio	SVR	$R_S \leq 10k\Omega$	70	100	-	dB
Operating Current	$I_{CC}$	$R_L = \infty$ each amplifier	-	200	250	$\mu A$
Slew Rate	SR	$R_L=10k\Omega$	-	3.5	-	V/ $\mu s$
Equivalent Input Noise Voltage	$e_n$	$R_S=100\Omega, f=1kHz$	-	35	-	nV/ $\sqrt{Hz}$

## TYPICAL CHARACTERISTICS

### Voltage Gain, Phase Shift vs. Frequency

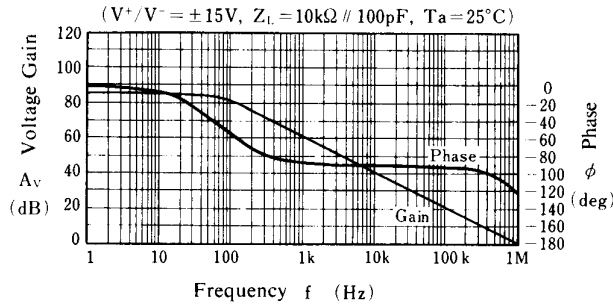

### Maximum Output Voltage Swing vs. Frequency

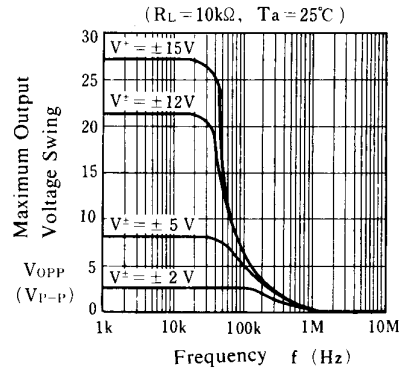

### Maximum Output Voltage Swing vs. Load Resistance

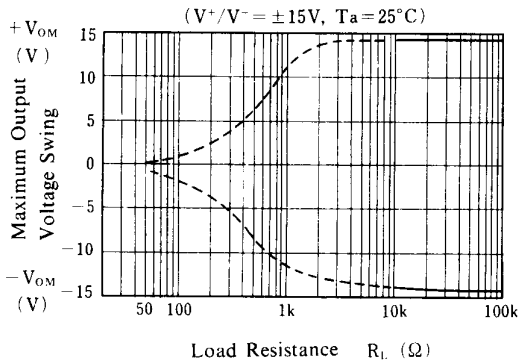

### Maximum Output Voltage Swing vs. Output Current

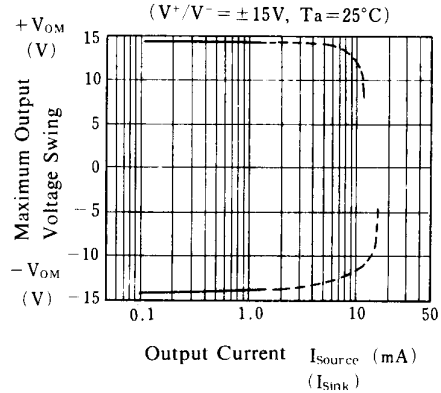

### Equivalent Input Noise Voltage vs. Frequency

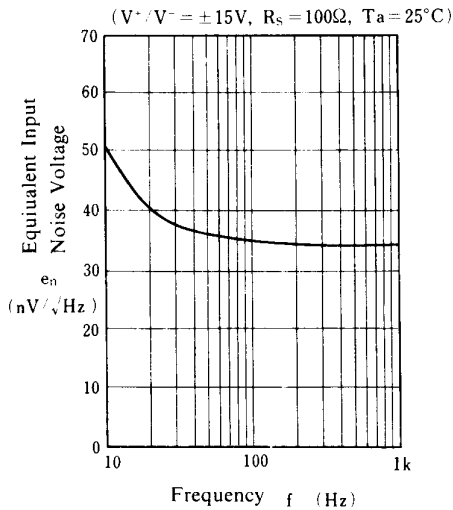

### Voltage Follower Large Signal Pulse Response

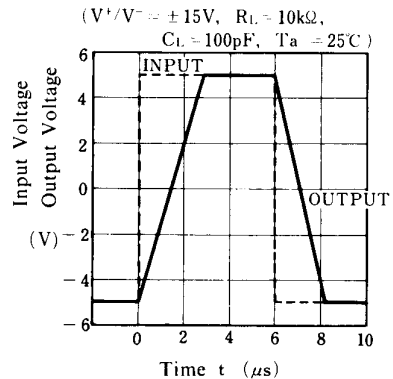

■ TYPICAL CHARACTERISTICS

**Operating Current vs. Temperature**

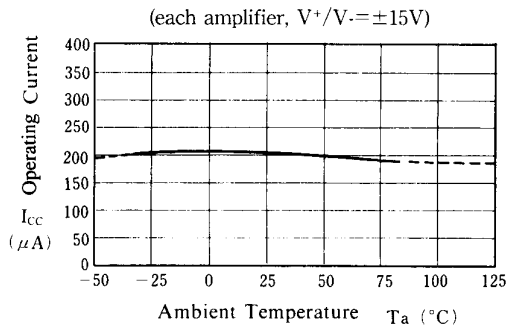

**Maximum Output Voltage Swing vs. Temperature**

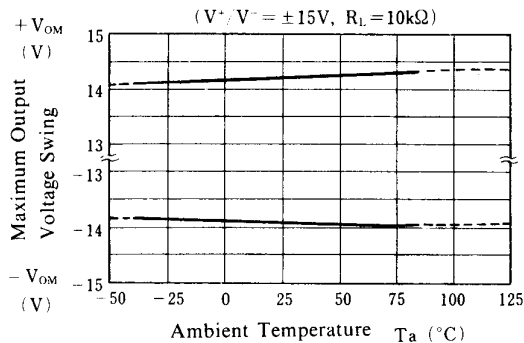

**Input Offset Voltage vs. Temperature**

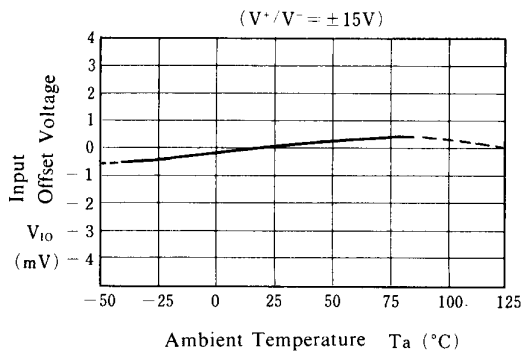

**Input Bias Current vs. Temperature**

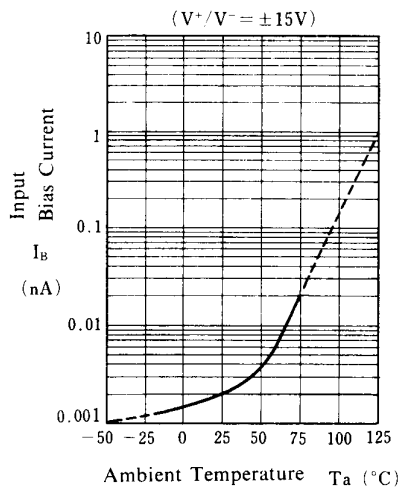

**Maximum Output Voltage Swing vs. Operating Voltage**

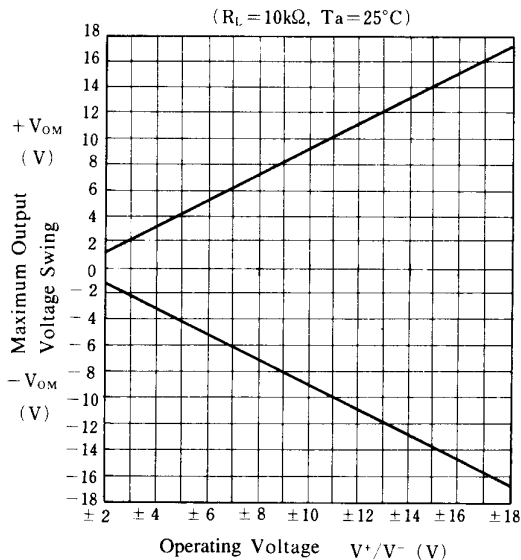

**Operating Current vs. Operating Voltage**

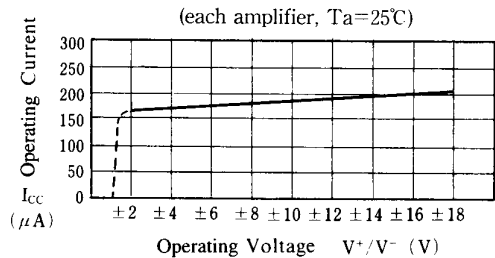

## MEMO

[CAUTION]  
The specifications on this databook are only given for information, without any guarantee as regards either mistakes or omissions. The application circuits in this databook are described only to show representative usages of the product and not intended for the guarantee or permission of any right including the industrial rights.