

5-INPUT 3-OUTPUT VIDEO SWITCH

■ GENERAL DESCRIPTION

The **NJM2595** is a 5-input 3-output video switch. Its switches select one from five signals received from VTR, TV, DVD, TV-GAME and others.

The NJM2595 is designed for audio items, such as AV amplifier and others.

■ PACKAGE OUTLINE

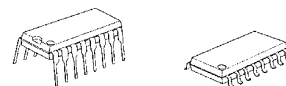

NJM2595D **NJM2595M**

■ FEATURES

- 5-input 3-output
- Operating Voltage ± 4.0 to $\pm 6.5V$
- Operating current $\pm 15mA$ typ. at $V_{CC}=\pm 5V$
- Crosstalk $-65dB$ typ.
- Internal 6dB Amplifier
- Internal 75Ω Driver
- Bipolar Technology
- Package Outline DIP16, DMP16

■ PIN CONFIGURATION and BLOCK DIAGRAM

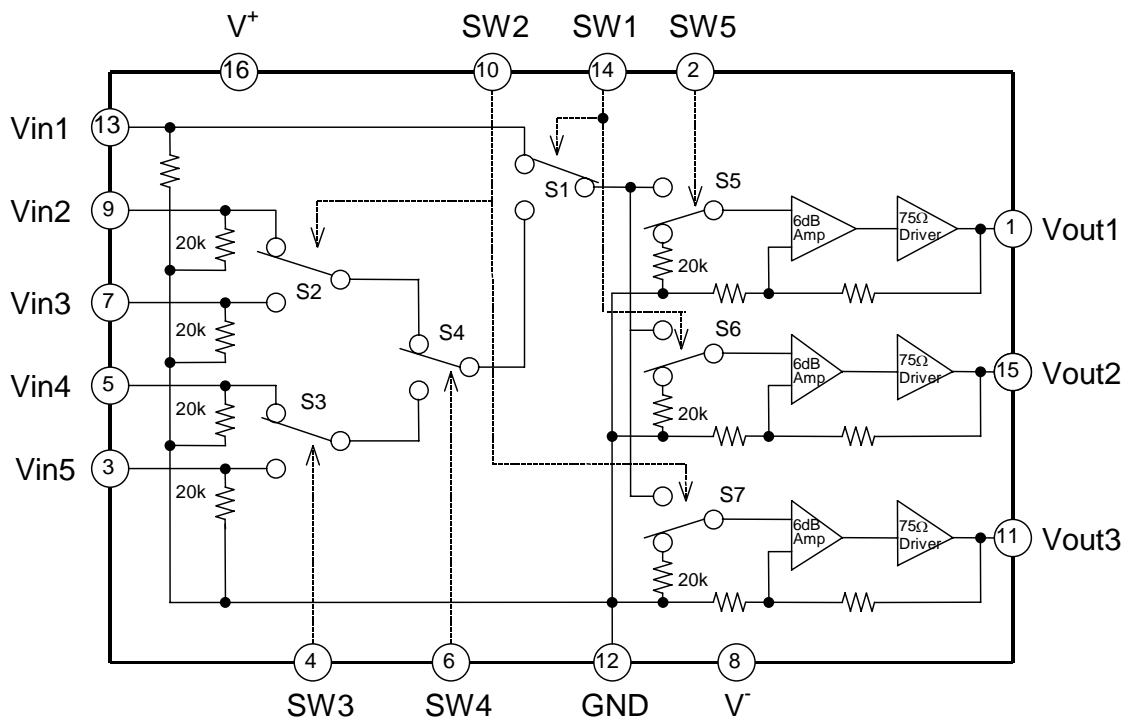

NJM2595

■ ABSOLUTE MAXIMUM RATINGS

(Ta=25°C)

PARAMETER	SYMBOL	RATINGS	UNIT
Supply Voltage	V ^{+/-}	±7.0	V
Power Dissipation	P _D	(DIP16) 700 (DMP16) 350	mW
Operating Temperature Range	Topr	-40 to +85	°C
Storage Temperature Range	Tstg	-40 to +125	°C

■ ELECTRICAL CHARACTERISTICS (V⁺/V⁻=±5V, R_L=150Ω, Ta=25°C)

PARAMETER	SYMBOL	TEST CONDITION	MIN.	TYP.	MAX.	UNIT
Positive Operating Current	I _{cc}	No signal	-	15	22	mA
Negative Operating Current	I _{ee}	No signal	-22	-15	-	mA
Voltage Gain	G _v	V _{in} =1.0V _{pp} , f=100kHz	6.0	6.3	6.8	dB
Frequency Characteristic	G _f	V _{in} =1.0V _{pp} , f=5MHz/100kHz	-1.0	0.0	+1.0	dB
Differential Gain	DG	V _{in} =1.0V _{pp} , Typical stair-case signal	-	0.2	-	%
Differential Phase	DP	V _{in} =1.0V _{pp} , Typical stair-case signal	-	0.2	-	deg
Output Offset Voltage 1	V _{os1}	No signal, between Vin2 and Vin3	-40	0.0	+40	mV
Output Offset Voltage 2	V _{os2}	No signal, between Vin1 and Vin2, between Vin1 and Vin3	-60	0.0	+60	
Between Input Crosstalk	CT	V _{in} =1.0V _{pp} , f=4.43MHz, V _o /V _{in}	-	-65	-	dB
Crosstalk at Mute	CT _m	V _{in} =1.0V _{pp} , f=4.43MHz, V _o /V _{in}	-	-55	-	dB
Total Harmonic Distortion	THD	V _{in} =1.25V _{pp} , f=1kHz	-	0.1	-	%
Switch Select Voltage at High	V _{ch}		2.0	-	V ⁺	V
Switch Select Voltage at Low	V _{cl}		0	-	0.8	
Input Impedance	R _{in}		-	20	-	KΩ

■ Control Signal vs. Output Signal (L=V_{CL}, H=V_{CH}, X=L or H)

SW1	SW2	SW3	SW4	SW5	Vout1	Vout2	Vout3
L	H	X	X	H	Vin1	MUTE	Vin1
	L			Vin1	MUTE	MUTE	
	H			MUTE	MUTE	Vin1	
H	L	X	L	H	Vin2	Vin2	MUTE
				L	MUTE	Vin2	MUTE
H	H	X	L	H	Vin3	Vin3	Vin3
				L	MUTE	Vin3	Vin3
H	H	L	H	H	Vin4	Vin4	Vin4
	H			MUTE	Vin4	Vin4	
	L			Vin4	Vin4	MUTE	
	L			MUTE	Vin4	MUTE	
H	H	H	H	H	Vin5	Vin5	Vin5
	H			MUTE	Vin5	Vin5	
	L			Vin5	Vin5	MUTE	
	L			MUTE	Vin5	MUTE	
L	L	X	X	L	MUTE	MUTE	MUTE

New Japan Radio Co., Ltd.

■ EQUIVALENT CIRCUIT

PIN No.	PIN NAME	INSIDE EQUIVALENT CIRCUIT	VOLTAGE
16	V ⁺		5V
8	V ⁻		-5V
12	GND		-
13 9 7 5 3	Vin1 Vin2 Vin3 Vin4 Vin5		0V
1 15 11	Vout1 Vout2 Vout3		0V
4 6 2	SW3 SW4 SW5		-

NJM2595

■ EQUIVALENT CIRCUIT

PIN No.	PIN NAME	INSIDE EQUIVALENT CIRCUIT	VOLTAGE
14 10	SW1 SW2		-

■ TEST CIRCUIT

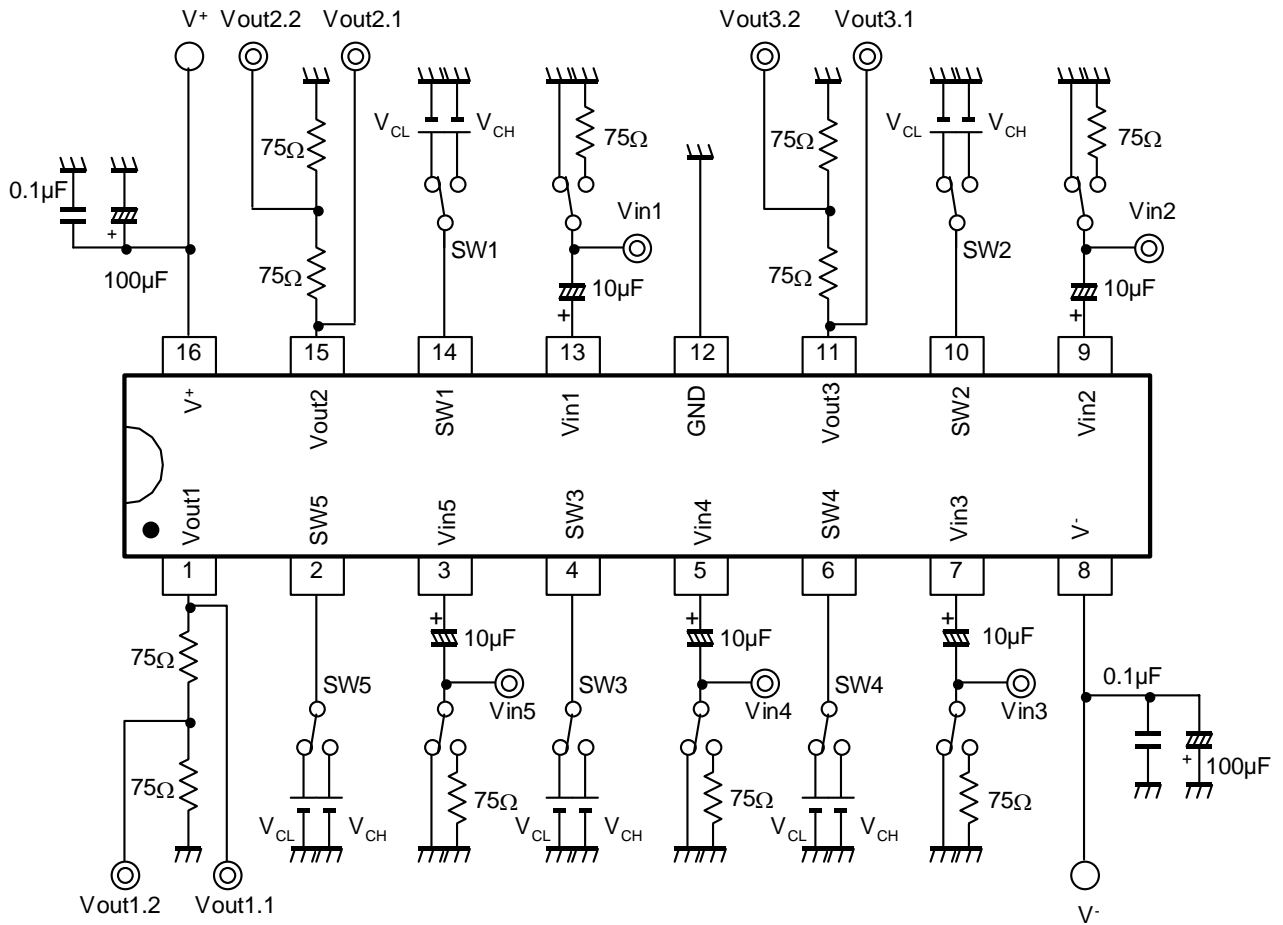

APPLICATION CIRCUIT

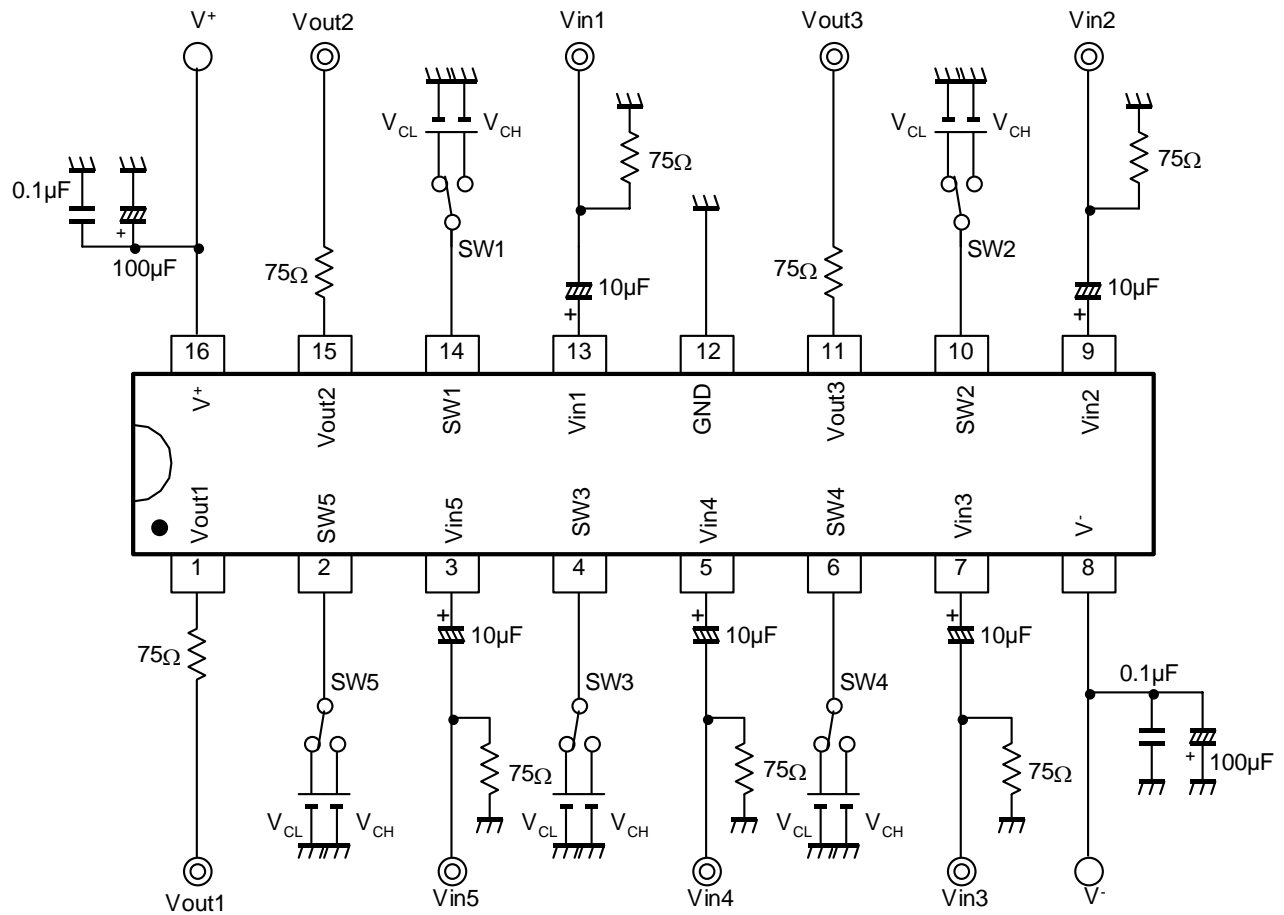

■ TYPICAL CHARACTERISTICS

Voltage Gain vs. Frequency

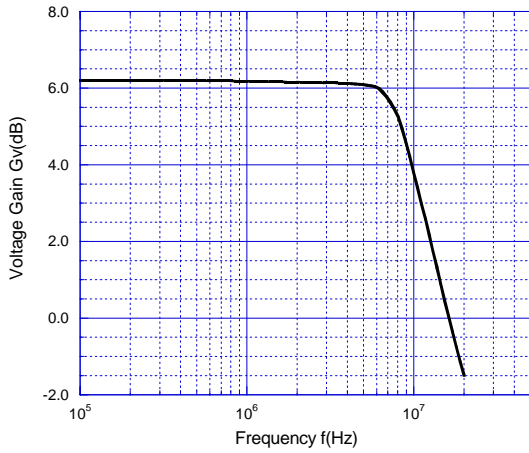

Maximum Output Voltage Swing vs. Supply Voltage

Total Harmonic Distortion=1%, 100kHz

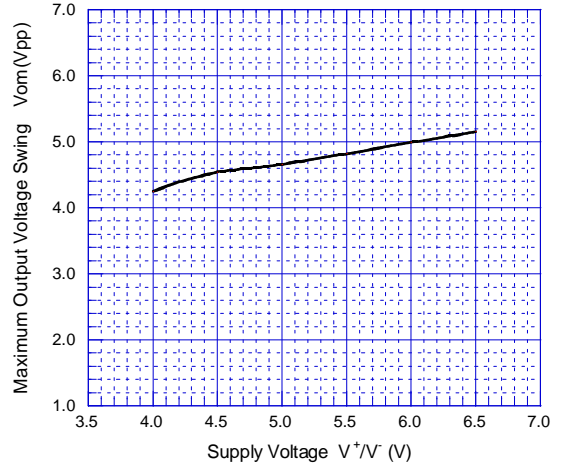

Operating Current vs. Supply Voltage

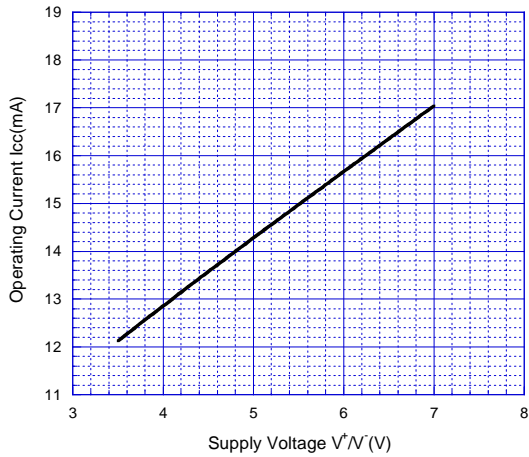

Operating Current vs. Supply Voltage

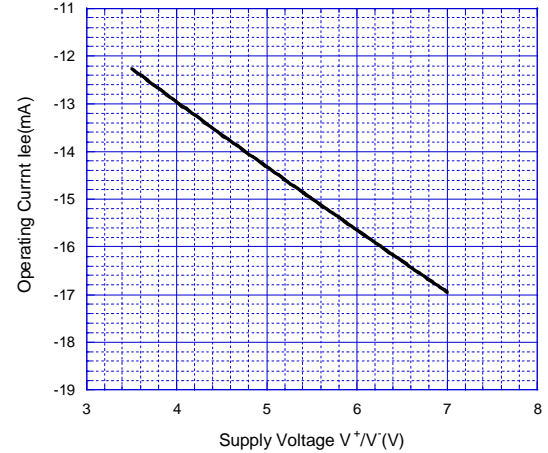

Voltage Gain vs. Supply Voltage

1Vpp, 100kHz SinWave

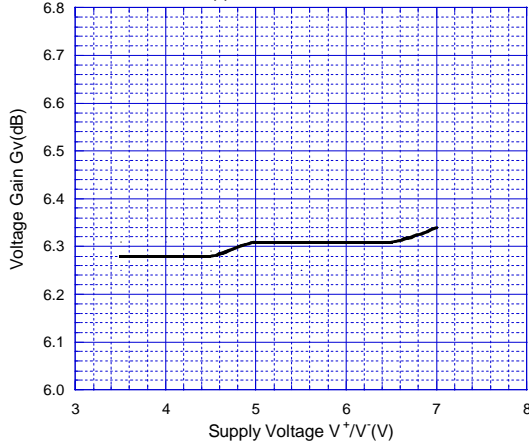

Gain Frequency Characteristic vs. Supply Voltage

1Vpp, 5MHz/100kHz SinWave

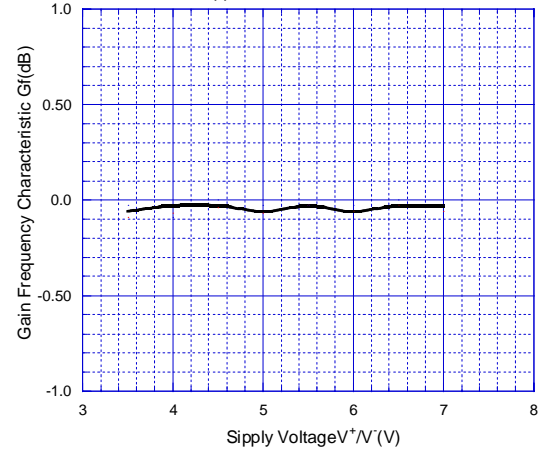

■ TYPICAL CHARACTERISTICS

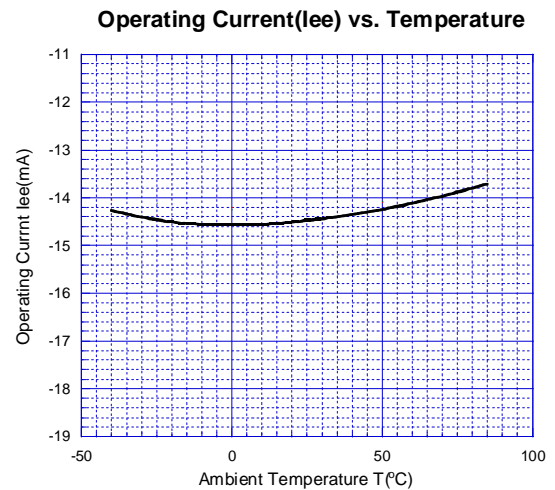
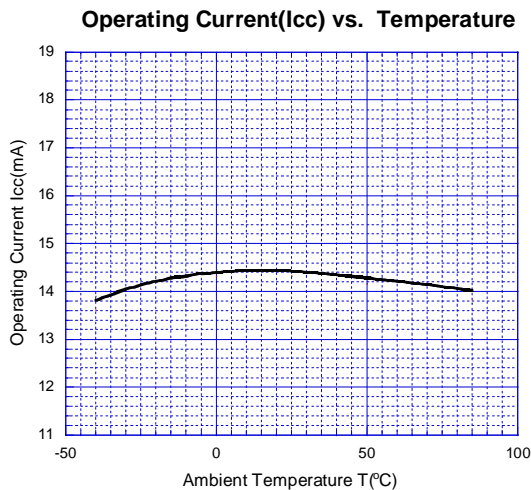
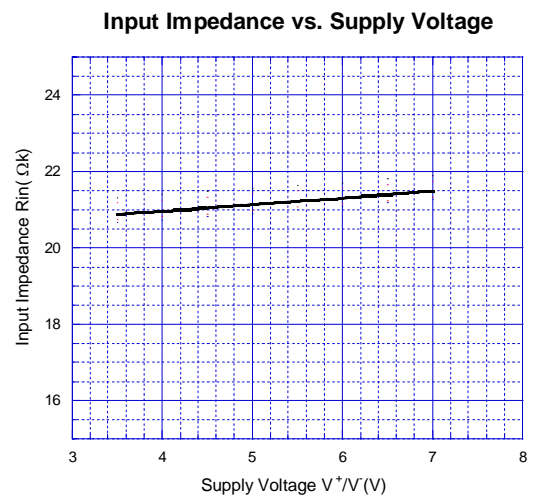
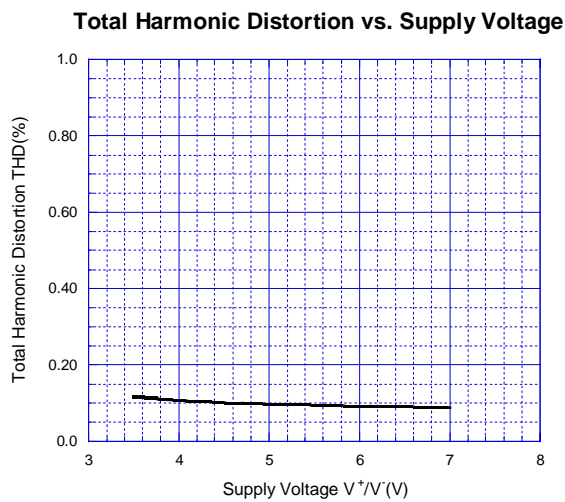
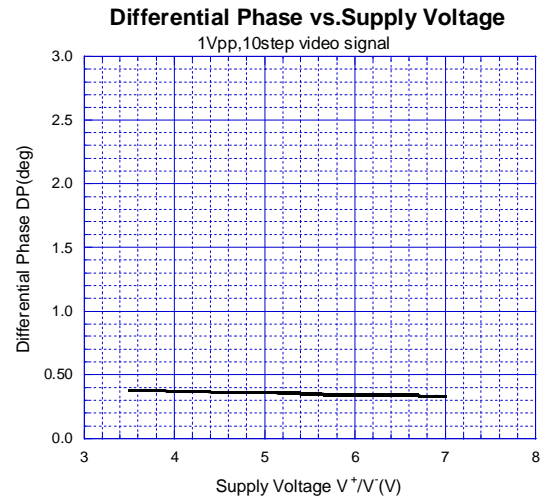
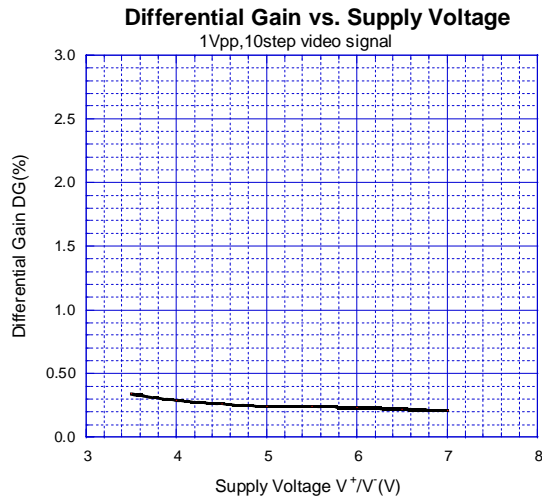

■ TYPICAL CHARACTERISTICS

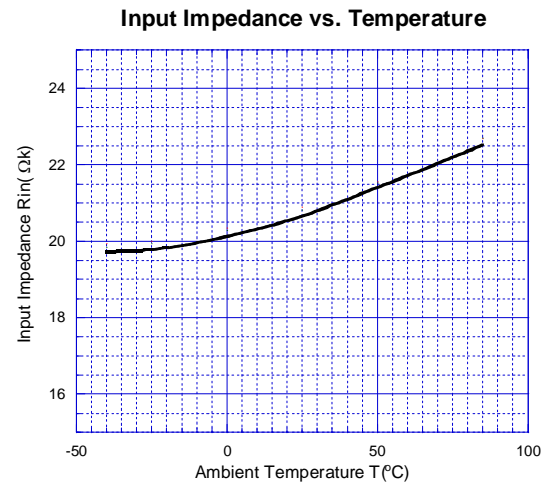
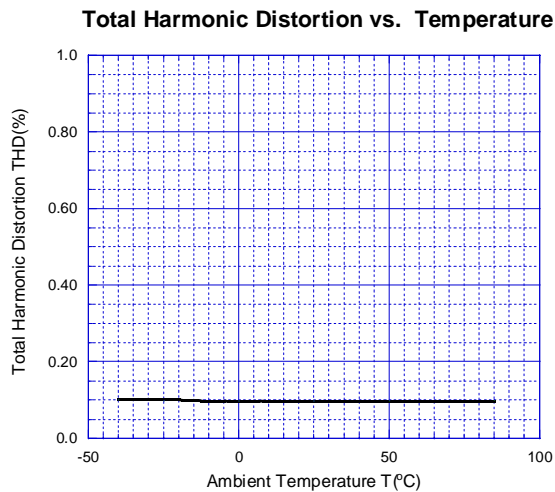
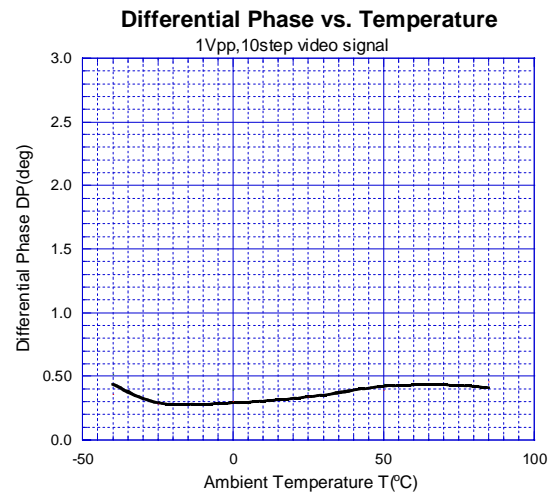
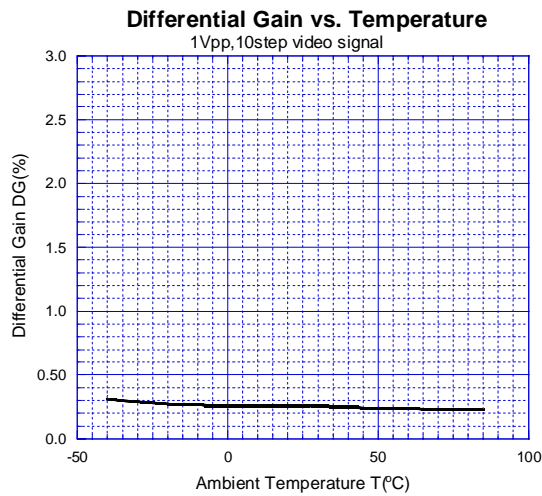
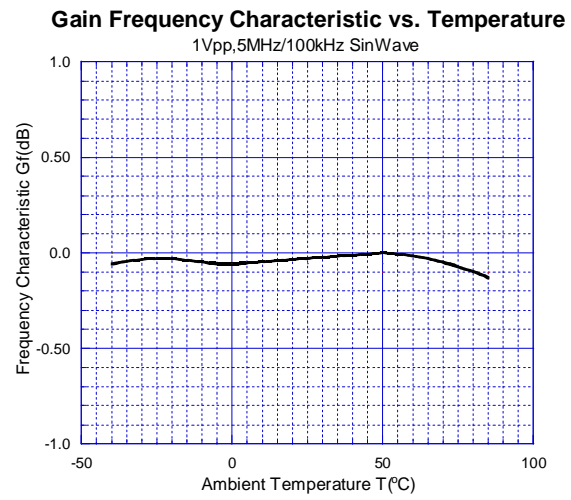
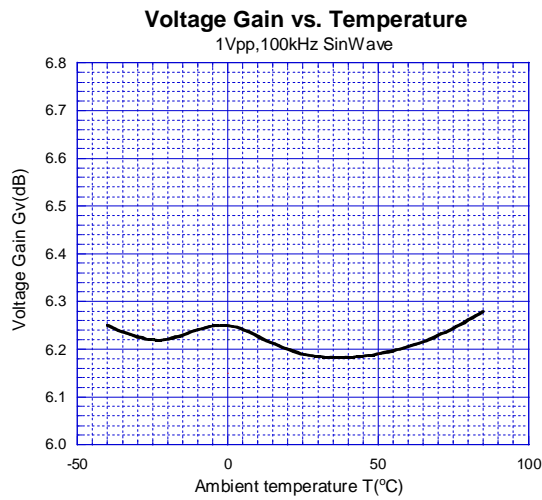

[CAUTION]
The specifications on this databook are only given for information, without any guarantee as regards either mistakes or omissions. The application circuits in this databook are described only to show representative usages of the product and not intended for the guarantee or permission of any right including the industrial rights.