

QSE156, QSE157, QSE158, QSE159 QSE156C, QSE157C, QSE158C, QSE159C Plastic Silicon OPTOLOGIC® Photosensor

Features

- Bipolar silicon IC
- Package type: Sidelooker
- Medium wide reception angle, 50°
- Package material and color: black epoxy
- Also available in clear package: "C" suffix
- Matched emitter: QEE113/QEE123
- Daylight filter
- High sensitivity
- Direct TTL/LSTTL interface

Description

The QSE15X family are OPTOLOGIC® ICs which feature a Schmitt trigger at output which provides hysteresis for noise immunity and pulse shaping. The basic building block of this IC consists of a photodiode, a linear amplifier, voltage regulator, Schmitt trigger and four output options. The TTL/LSTTL compatible output can drive up to ten TTL loads over supply currents from 4.5 to 16.0 Volts. The devices are marked with a color stripe for easy identification.

Package Dimensions

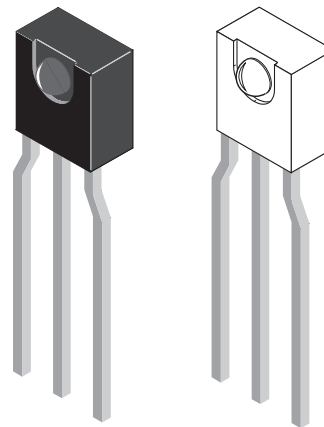
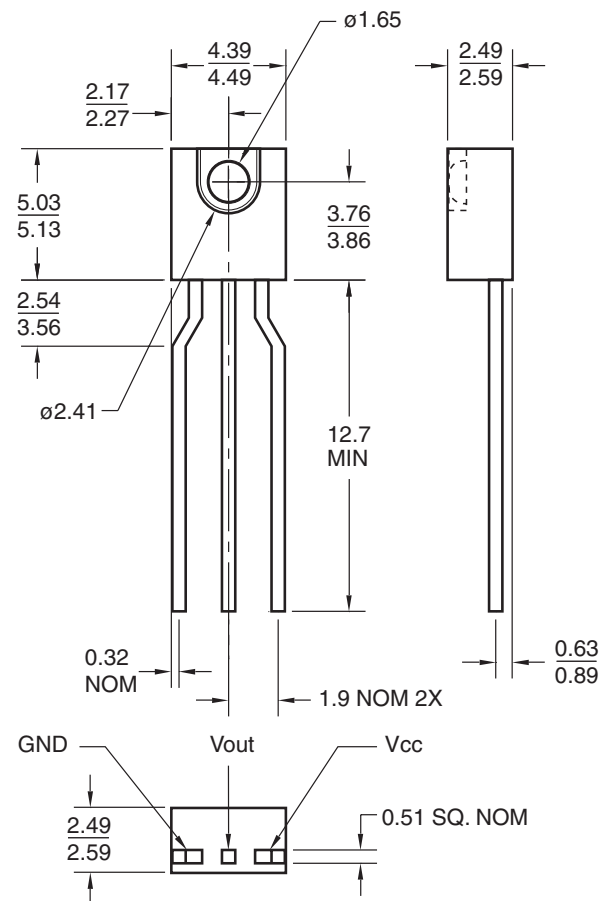

Part Number Definitions		Color Code
QSE156/C	Totem-Pole, buffer output	Red
QSE157/C	Totem-Pole, inverter output	Yellow
QSE158/C	Open-collector, buffer output	Green
QSE159/C	Open-collector, inverter output	Blue

Input/Output Table		
Part Number	Light	Output
QSE156/C	On	HIGH
	Off	LOW
QSE157/C	On	LOW
	Off	HIGH
QSE158/C	On	HIGH
	Off	LOW
QSE159/C	On	LOW
	Off	HIGH

Note:

1. Dimensions for all drawings are in millimeters.

Block Diagrams

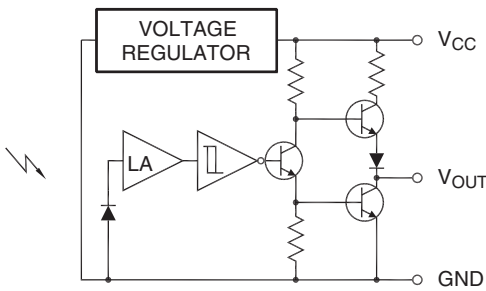

QSE156
Totem-Pole Output Buffer

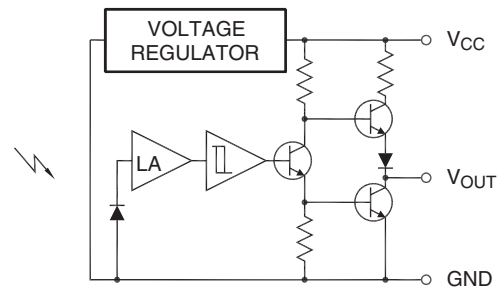

QSE157
Totem-Pole Output Inverter

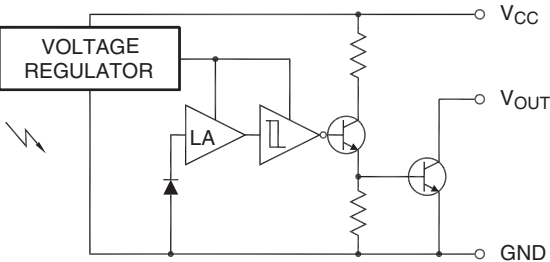

QSE158
Open-Collector Output Buffer

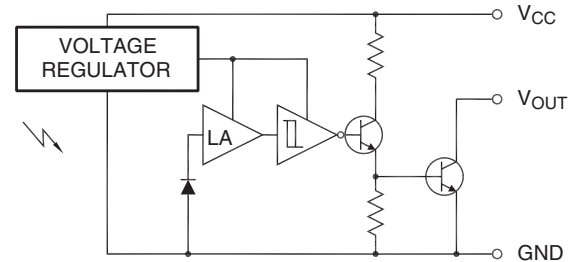

QSE159
Open-Collector Output Inverter

Absolute Maximum Ratings ($T_A = 25^\circ\text{C}$ unless otherwise specified)

Stresses exceeding the absolute maximum ratings may damage the device. The device may not function or be operable above the recommended operating conditions and stressing the parts to these levels is not recommended. In addition, extended exposure to stresses above the recommended operating conditions may affect device reliability. The absolute maximum ratings are stress ratings only.

Symbol	Parameter	Rating	Unit
T_{OPR}	Operating Temperature	-40 to +85	$^\circ\text{C}$
T_{STG}	Storage Temperature	-40 to +100	$^\circ\text{C}$
T_{SOL-I}	Soldering Temperature (Iron) ^(2,3,4)	240 for 5 sec	$^\circ\text{C}$
T_{SOL-F}	Soldering Temperature (Flow) ^(2,3)	260 for 10 sec	$^\circ\text{C}$
I_O	Output Current	50	mA
V_{CC}	Supply Voltage	4.0 to 16	V
V_O	Output Voltage	35	V
P_D	Power Dissipation ⁽¹⁾	100	mW

Notes:

1. Derate power dissipation linearly 2.50mW/ $^\circ\text{C}$ above 25 $^\circ\text{C}$.
2. RMA flux is recommended.
3. Methanol or isopropyl alcohols are recommended as cleaning agents.
4. Soldering iron tip 1/16" (1.6mm) minimum from housing.

Electrical Characteristics ($T_A = -40^\circ\text{C}$ to $+85^\circ\text{C}$, $V_{CC} = 4.5\text{V}$ to 16V)

Symbol	Parameter	Test Conditions	Min.	Typ.	Max.	Units
$E_e(+)$	Positive Going Threshold Irradiance ⁽⁵⁾	$T_A = 25^\circ\text{C}$	0.025		0.250	mW/cm^2
$E_e(+)/E_e(-)$	Hysteresis Ratio		1.10		2.00	
I_{CC}	Supply Current ⁽⁶⁾	$E_e = 0$ or $0.3\text{mW}/\text{cm}^2$			5.0	mA
	Peak to Peak Ripple which will Cause False Triggering	$f = \text{DC to } 50\text{MHz}$			2.00	V
QSE156/C (Buffer Totem Pole)						
V_{OH}	High Level Output Voltage ⁽⁵⁾	$E_e = 0.3\text{mW}/\text{cm}^2$, $I_{OH} = -10\text{mA}$	$V_{CC} - 2.1$			V
V_{OL}	Low Level Output Voltage	$E_e = 0$, $I_{OL} = 16\text{mA}$			0.40	V
QSE157/C (Inverter Totem Pole)						
V_{OH}	High Level Output Voltage ⁽⁵⁾	$E_e = 0$, $I_{OH} = -10\text{mA}$	$V_{CC} - 2.1$			V
V_{OL}	Low Level Output Voltage	$E_e = 0.3\text{mW}/\text{cm}^2$, $I_{OL} = 16\text{mA}$			0.40	V
QSE158/C (Buffer Open Collector)						
I_{OH}	High Level Output Current ⁽⁵⁾	$E_e = 0.3\text{mW}/\text{cm}^2$, $V_{OH} = 30\text{V}$			100	μA
V_{OL}	Low Level Output Voltage	$E_e = 0$, $I_{OL} = 16\text{mA}$			0.40	V
QSE159/C (Inverter Open Collector)						
I_{OH}	High Level Output Current ⁽⁵⁾	$E_e = 0$, $V_{OH} = 30\text{V}$			100	μA
V_{OL}	Low Level Output Voltage	$E_e = 0.3\text{mW}/\text{cm}^2$, $I_{OL} = 16\text{mA}$			0.40	V
QSE156/C, QSE157/C						
t_R , t_F	Output Rise, Fall Times	$E_e = 0$ or $0.3\text{mW}/\text{cm}^2$, $f = 10\text{kHz}$, $\text{DC} = 50\%$, $R_L = 360\Omega$ ⁽⁵⁾			70	nS
t_{PHL} , t_{PLH}	Propagation Delay			6.0		μS
QSE158/C, QSE159/C						
t_R , t_F	Output Rise, Fall Times	$E_e = 0$ or $0.3\text{mW}/\text{cm}^2$, $f = 10\text{kHz}$, $\text{DC} = 50%$, $R_L = 360\Omega$ ⁽⁵⁾			100	nS
t_{PHL} , t_{PLH}	Propagation Delay			6.0		μS

Note:5. $\lambda = 880\text{nm}$ (AlGaAs).

Typical Performance Curves (Sensor Coupled to QEE113 Emitter)

Fig. 1 Output Voltage vs. Input Current (Inverters)

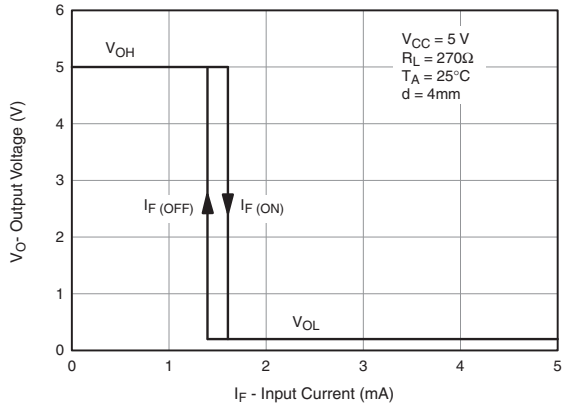

Fig. 2 Output Voltage vs. Input Current (Buffers)

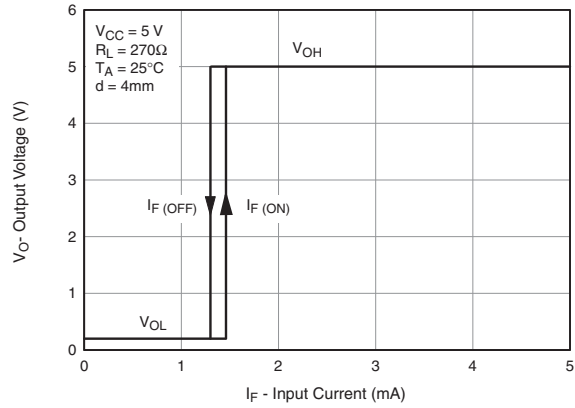

Fig. 3 Threshold Current vs. Distance

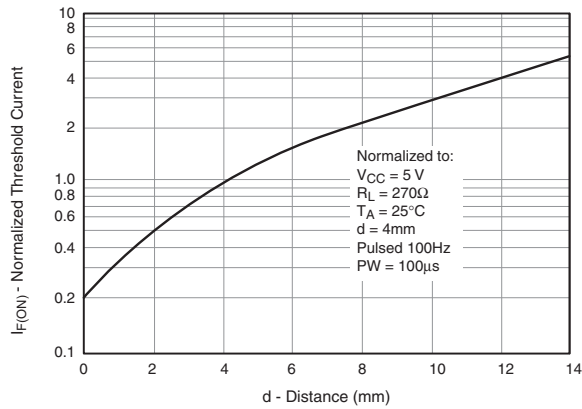
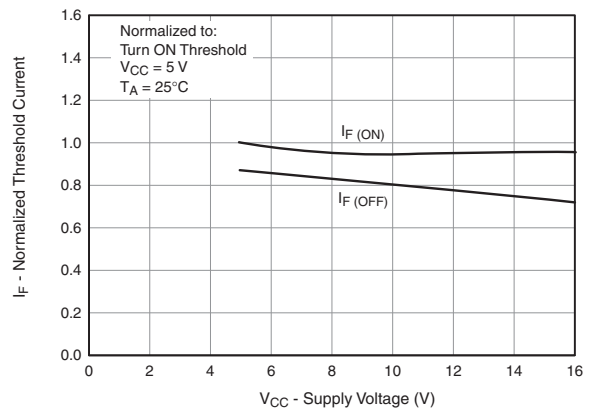

Fig. 4 Normalized Threshold Current vs. Supply Voltage



Typical Performance Curves (Sensor Coupled to QEE113 Emitter) (Continued)

Fig. 5 Normalized Threshold Current vs. Ambient Temperature

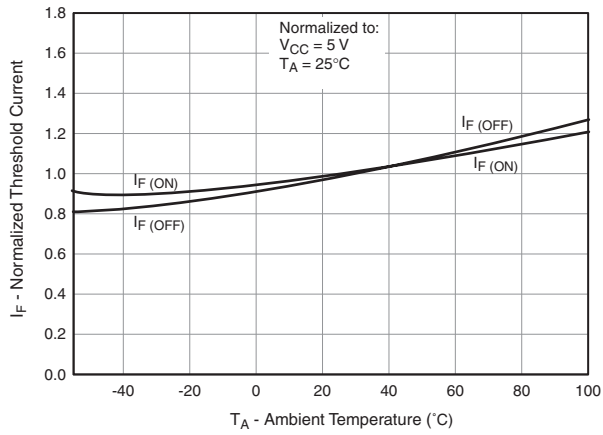

Fig. 6 Low Output Voltage vs. Output Current

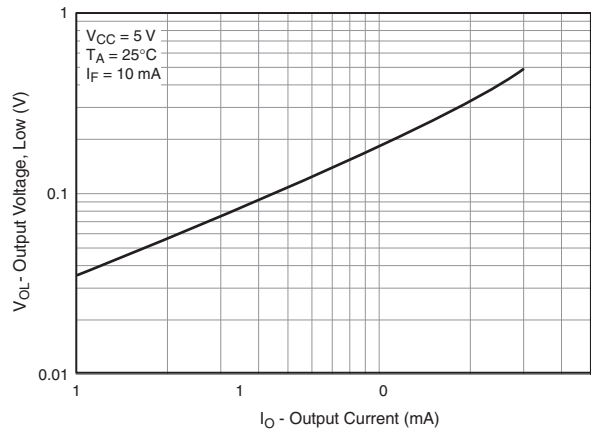

Fig. 7 Response Time vs. Forward Current

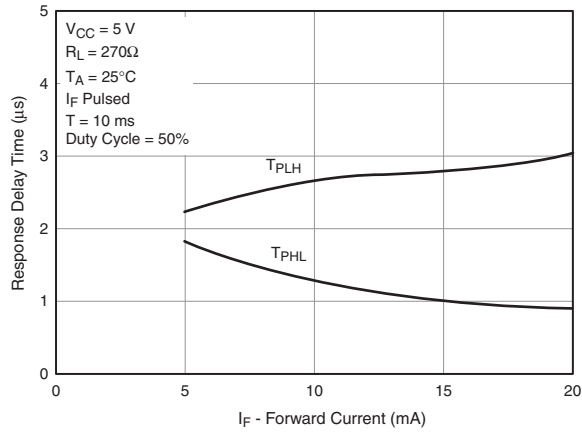

Fig. 8 Switching Speed Test Circuit

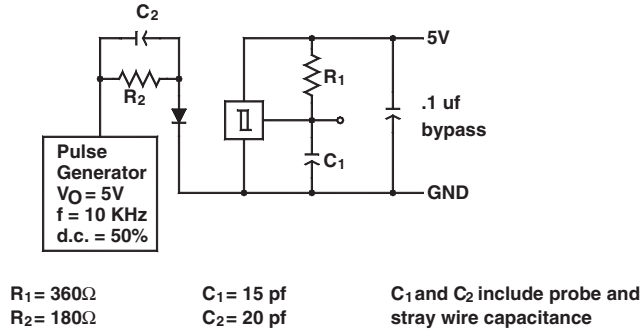

Fig. 9 Switching Times Definition for Buffers

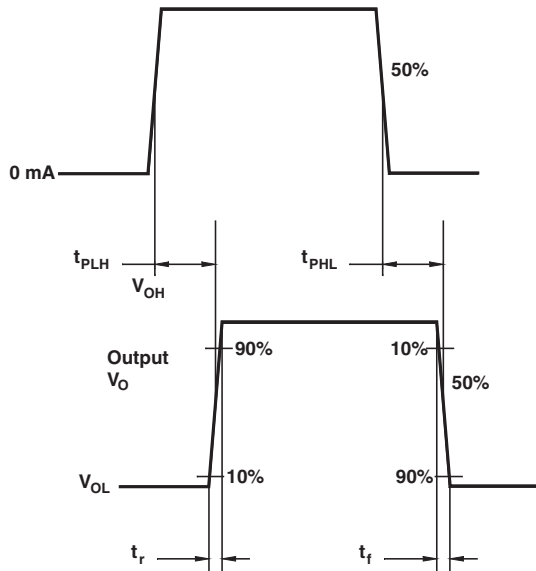
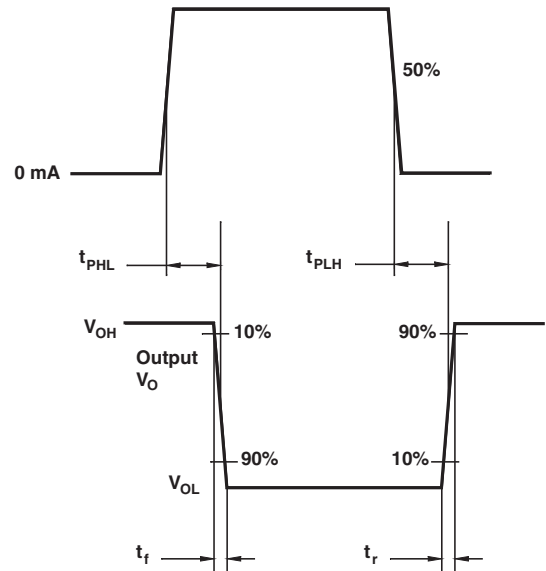



Fig. 10 Switching Times Definition for Inverters





TRADEMARKS

The following are registered and unregistered trademarks and service marks Fairchild Semiconductor owns or is authorized to use and is not intended to be an exhaustive list of all such trademarks.

ACEx®	Green FPS™	Power247®	SuperSOT™-8
Build it Now™	Green FPS™ e-Series™	POWEREDGE®	SyncFET™
CorePLUS™	GTO™	Power-SPM™	The Power Franchise®
CROSSVOLT™	i-Lo™	PowerTrench®	the power franchise
CTL™	IntelliMAX™	Programmable Active Droop™	TinyBoost™
Current Transfer Logic™	ISOPLANAR™	QFET®	TinyBuck™
EcoSPARK®	MegaBuck™	QS™	TinyLogic®
F ®	MICROCOUPLER™	QT Optoelectronics™	TINYOPTO™
Fairchild®	MicroFET™	Quiet Series™	TinyPower™
Fairchild Semiconductor®	MicroPak™	RapidConfigure™	TinyPWM™
FACT Quiet Series™	MillerDrive™	SMART START™	TinyWire™
FACT®	Motion-SPM™	SPM®	μSerDes™
FAST®	OPTOLOGIC®	STEALTH™	UHC®
FastvCore™	OPTOPLANAR®	SuperFET™	UniFET™
FPS™	 ®	SuperSOT™-3	VCX™
FRFET®	PDP-SPM™	SuperSOT™-6	
Global Power Resource™	Power220®		

DISCLAIMER

FAIRCHILD SEMICONDUCTOR RESERVES THE RIGHT TO MAKE CHANGES WITHOUT FURTHER NOTICE TO ANY PRODUCTS HEREIN TO IMPROVE RELIABILITY, FUNCTION, OR DESIGN. FAIRCHILD DOES NOT ASSUME ANY LIABILITY ARISING OUT OF THE APPLICATION OR USE OF ANY PRODUCT OR CIRCUIT DESCRIBED HEREIN; NEITHER DOES IT CONVEY ANY LICENSE UNDER ITS PATENT RIGHTS, NOR THE RIGHTS OF OTHERS. THESE SPECIFICATIONS DO NOT EXPAND THE TERMS OF FAIRCHILD'S WORLDWIDE TERMS AND CONDITIONS, SPECIFICALLY THE WARRANTY THEREIN, WHICH COVERS THESE PRODUCTS.

LIFE SUPPORT POLICY

FAIRCHILD'S PRODUCTS ARE NOT AUTHORIZED FOR USE AS CRITICAL COMPONENTS IN LIFE SUPPORT DEVICES OR SYSTEMS WITHOUT THE EXPRESS WRITTEN APPROVAL OF FAIRCHILD SEMICONDUCTOR CORPORATION.

As used herein:

1. Life support devices or systems are devices or systems which, (a) are intended for surgical implant into the body or (b) support or sustain life, and (c) whose failure to perform when properly used in accordance with instructions for use provided in the labeling, can be reasonably expected to result in a significant injury of the user.
2. A critical component in any component of a life support, device, or system whose failure to perform can be reasonably expected to cause the failure of the life support device or system, or to affect its safety or effectiveness.

PRODUCT STATUS DEFINITIONS

Definition of Terms

Datasheet Identification	Product Status	Definition
Advance Information	Formative or In Design	This datasheet contains the design specifications for product development. Specifications may change in any manner without notice.
Preliminary	First Production	This datasheet contains preliminary data; supplementary data will be published at a later date. Fairchild Semiconductor reserves the right to make changes at any time without notice to improve design.
No Identification Needed	Full Production	This datasheet contains final specifications. Fairchild Semiconductor reserves the right to make changes at any time without notice to improve design.
Obsolete	Not In Production	This datasheet contains specifications on a product that has been discontinued by Fairchild Semiconductor. The datasheet is printed for reference information only.

Rev. 131