



Features

- 14A Peak Source/Sink Drive Current
- Wide Operating Voltage Range: 4.5V to 35V
- -40°C to +125°C Extended Operating Temperature Range
- Logic Input Withstands Negative Swing of up to 5V
- Low Propagation Delay Time: 30ns
- Low, 10µA Supply Current
- Low Output Impedance

Applications

- Efficient Power MOSFET and IGBT Switching
- Switch Mode Power Supplies
- Motor Controls
- DC to DC Converters
- Class-D Switching Amplifiers
- Pulse Transformer Driver



Description

The IXDD614 / IXDI614 / IXDN614 high-speed gate drivers are especially well suited for driving the latest IXYS MOSFETs and IGBTs. Each output can source and sink 14A of peak current while producing voltage rise and fall times of less than 30ns. Internal circuitry eliminates cross-conduction and current "shoot-through," and the driver is virtually immune to latch up. Low propagation delay and fast rise and fall times make the IXD_614 family ideal for high-frequency and high-power applications.

The IXDD614 is configured as a non-inverting driver with an enable. The IXDN614 is configured as a non-inverting driver, and the IXDI614 is configured as an inverting driver.

The IXD_614 family is available in an 8-pin DIP (PI), an 8-lead Power SOIC with an exposed metal back (SI), a 5-pin TO-220 (CI), and a 5-lead TO-263 (YI) package.

Ordering Information

Part Number	Logic Configuration	Package Type	Packing Method	Quantity
IXDD614PI		8-Pin DIP	Tube	50
IXDD614SI		8-Lead Power SOIC with Exposed Metal Back	Tube	100
IXDD614SITR		8-Lead Power SOIC with Exposed Metal Back	Tape & Reel	2000
IXDD614CI		5-Pin TO-220	Tube	50
IXDD614YI		5-Lead TO-263	Tube	50
IXDI614PI		8-Pin DIP	Tube	50
IXDI614SI		8-Lead Power SOIC with Exposed Metal Back	Tube	100
IXDI614SITR		8-Lead Power SOIC with Exposed Metal Back	Tape & Reel	2000
IXDI614CI		5-Pin TO-220	Tube	50
IXDI614YI		5-Lead TO-263	Tube	50
IXDN614PI		8-Pin DIP	Tube	50
IXDN614SI		8-Lead Power SOIC with Exposed Metal Back	Tube	100
IXDN614SITR		8-Lead Power SOIC with Exposed Metal Back	Tape & Reel	2000
IXDN614CI		5-Pin TO-220	Tube	50
IXDN614YI		5-Lead TO-263	Tube	50

1. Specifications	3
1.1 Lead Configurations	3
1.2 Lead Definitions	3
1.3 Absolute Maximum Ratings	3
1.4 Electrical Characteristics: $T_A = 25^{\circ}\text{C}$	4
1.5 Electrical Characteristics: $T_A = -40^{\circ}\text{C}$ to $+125^{\circ}\text{C}$	5
1.6 Thermal Characteristics	5
2. Functional Description	6
2.1 IXDD614 Block Diagram & Truth Table	6
2.2 IXDI614 Block Diagram & Truth Table	6
2.3 IXDN614 Block Diagram & Truth Table	6
2.4 Timing Diagrams	7
2.5 Characteristics Test Diagram	7
3. Performance Data	8
4. Manufacturing Information	11
4.1 Mechanical Dimensions	11
4.1.1 SI (8-Lead Power SOIC with Exposed Metal Back)	11
4.1.2 YI (5-Lead TO-263)	11
4.1.3 CI (5-Pin TO-220)	12
4.1.4 PI (8-Pin DIP)	12

1 Specifications

1.1 Lead Configurations

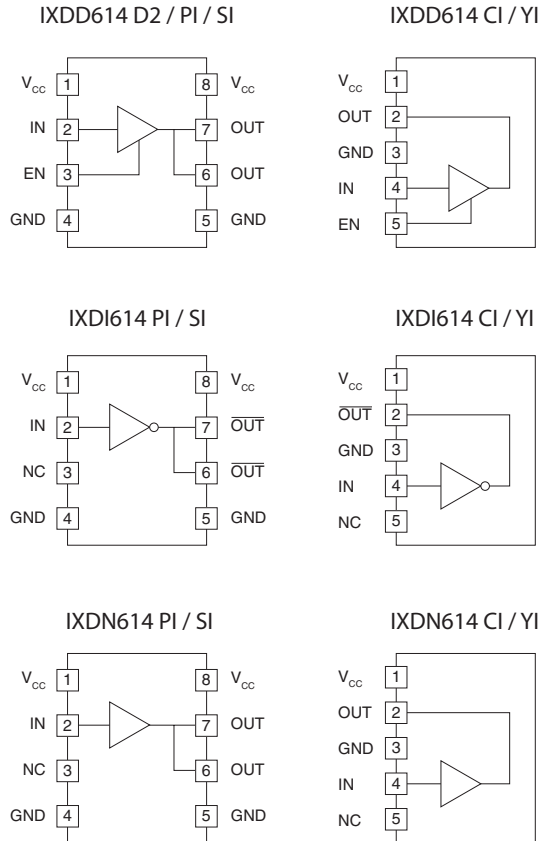

1.2 Lead Definitions

Lead Name	Description
IN	Logic Input
EN	Output Enable - Drive lead low to disable output, and force output to a high impedance state
OUT	Output - Sources or sinks current to turn-on or turn-off a discrete MOSFET or IGBT
$\overline{\text{OUT}}$	Inverted Output - Sources or sinks current to turn-on or turn-off a discrete MOSFET or IGBT
V _{CC}	Supply Voltage - Provides power to the device
GND	Ground - Common ground reference for the device
NC	Not connected

1.3 Absolute Maximum Ratings

Parameter	Symbol	Minimum	Maximum	Units
Supply Voltage	V _{CC}	-0.3	40	V
Input Voltage	V _{IN} , V _{EN}	-5	V _{CC} +0.3	V
Output Current	I _{OUT}	-	±14	A
Junction Temperature	T _J	-55	+150	°C
Storage Temperature	T _{STG}	-65	+150	°C

Unless stated otherwise, absolute maximum electrical ratings are at 25°C

Absolute maximum ratings are stress ratings. Stresses in excess of these ratings can cause permanent damage to the device. Functional operation of the device at conditions beyond those indicated in the operational sections of this data sheet is not implied.

1.4 Electrical Characteristics: $T_A = 25^\circ\text{C}$

Test Conditions: $4.5\text{V} \leq V_{CC} \leq 35\text{V}$ (unless otherwise noted).

Parameter	Conditions	Symbol	Minimum	Typical	Maximum	Units
Input Voltage, High	$4.5\text{V} \leq V_{CC} \leq 18\text{V}$	V_{IH}	3.0	-	-	V
Input Voltage, Low	$4.5\text{V} \leq V_{CC} \leq 18\text{V}$	V_{IL}	-	-	0.8	
Input Current	$0\text{V} \leq V_{IN} \leq V_{CC}$	I_{IN}	-10	-	10	μA
EN Input Voltage, High	IXDD614 only	V_{ENH}	$2/3V_{CC}$	-	-	V
EN Input Voltage, Low	IXDD614 only	V_{ENL}	-	-	$1/3V_{CC}$	
Output Voltage, High	-	V_{OH}	$V_{CC}-0.025$	-	-	V
Output Voltage, Low	-	V_{OL}	-	-	0.025	
Output Resistance, High State	$V_{CC}=18\text{V}, I_{OUT}=-10\text{mA}$	R_{OH}	-	0.4	0.8	Ω
Output Resistance, Low State	$V_{CC}=18\text{V}, I_{OUT}=10\text{mA}$	R_{OL}	-	0.3	0.6	
Output Current, Continuous	Limited by package power dissipation	I_{DC}	-	-	± 4	A
Rise Time	$C_{LOAD}=15\text{nF}, V_{CC}=18\text{V}$	t_R	-	25	35	ns
Fall Time	$C_{LOAD}=15\text{nF}, V_{CC}=18\text{V}$	t_F	-	18	25	
On-Time Propagation Delay	$C_{LOAD}=15\text{nF}, V_{CC}=18\text{V}$	t_{ONDLY}	-	50	70	
Off-Time Propagation Delay	$C_{LOAD}=15\text{nF}, V_{CC}=18\text{V}$	t_{OFFDLY}	-	50	70	
Enable to Output-High Delay Time	IXDD614 only	t_{ENOH}	-	31	60	
Disable to High Impedance State Delay Time	IXDD614 only	t_{DOLD}	-	44	70	
Enable Pull-Up Resistor	IXDD614 only	R_{EN}	-	200	-	$\text{k}\Omega$
Power Supply Current	$V_{CC}=18\text{V}, V_{IN}=3.5\text{V}$	I_{CC}	-	1	2	mA
	$V_{CC}=18\text{V}, V_{IN}=0\text{V}$		-	-	10	
	$V_{CC}=18\text{V}, V_{IN}=V_{CC}$		-	-	10	μA

1.5 Electrical Characteristics: $T_A = -40^{\circ}\text{C}$ to $+125^{\circ}\text{C}$

Test Conditions: $4.5\text{V} \leq V_{CC} \leq 35\text{V}$.

Parameter	Conditions	Symbol	Minimum	Typical	Maximum	Units
Input Voltage, High	$4.5\text{V} \leq V_{CC} \leq 18\text{V}$	V_{IH}	3.3	-	-	V
Input Voltage, Low	$4.5\text{V} \leq V_{CC} \leq 18\text{V}$	V_{IL}	-	-	0.65	
Input Voltage Range	-	V_{IN}	-5	-	$V_{CC}+0.3$	
Input Current	$0\text{V} \leq V_{IN} \leq V_{CC}$	I_{IN}	-10	-	10	μA
Output Voltage, High	-	V_{OH}	$V_{CC}-0.025$	-	-	V
Output Voltage, Low	-	V_{OL}	-	-	0.025	
Output Resistance, High State	$V_{CC}=18\text{V}, I_{OUT}=-10\text{mA}$	R_{OH}	-	-	1.5	Ω
Output Resistance, Low State	$V_{CC}=18\text{V}, I_{OUT}=10\text{mA}$	R_{OL}	-	-	1.2	
Output Current, Continuous	Limited by package power dissipation	I_{DC}	-	-	± 1	A
Rise Time	$C_{LOAD}=15\text{nF}, V_{CC}=18\text{V}$	t_R	-	-	50	ns
Fall Time	$C_{LOAD}=15\text{nF}, V_{CC}=18\text{V}$	t_F	-	-	40	
On-Time Propagation Delay	$C_{LOAD}=15\text{nF}, V_{CC}=18\text{V}$	t_{ONDLY}	-	-	90	
Off-Time Propagation Delay	$C_{LOAD}=15\text{nF}, V_{CC}=18\text{V}$	t_{OFFDLY}	-	-	90	
Enable to Output-High Delay Time	IXDD614 only	t_{ENOH}	-	-	75	
Disable to High Impedance State Delay Time	IXDD614 only	t_{DOLD}	-	-	85	
Power Supply Current	$V_{CC}=18\text{V}, V_{IN}=3.5\text{V}$	I_{CC}	-	1.5	3	mA
	$V_{CC}=18\text{V}, V_{IN}=0\text{V}$		-	-	150	μA
	$V_{CC}=18\text{V}, V_{IN}=V_{CC}$		-	-	150	μA

1.6 Thermal Characteristics

Package	Parameter	Symbol	Rating	Units
CI (5-Pin TO-220)	Thermal Resistance, Junction-to-Ambient	θ_{JA}	36	$^{\circ}\text{C}/\text{W}$
PI (8-Pin DIP)			125	
SI (8-Lead Power SOIC)			85	
YI (5-Lead TO-263)			46	
CI (5-Pin TO-220)	Thermal Resistance, Junction-to-Case	θ_{JC}	3	$^{\circ}\text{C}/\text{W}$
SI (8-Lead Power SOIC)			10	
YI (5-Lead TO-263)			2	

2 Functional Description

2.1 IXDD614 Block Diagram & Truth Table

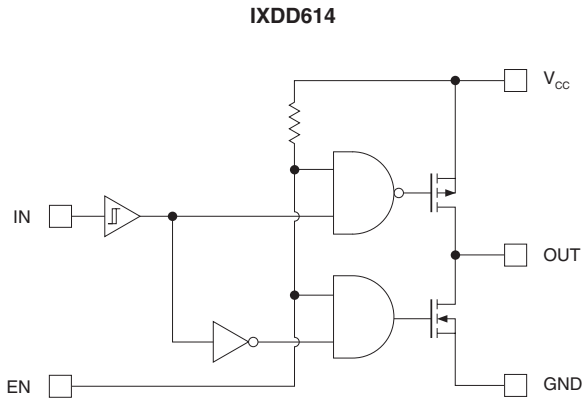

IN	EN	OUT
0	1 or open	0
1	1 or open	1
0	0	Z
1	0	Z

2.3 IXDN614 Block Diagram & Truth Table

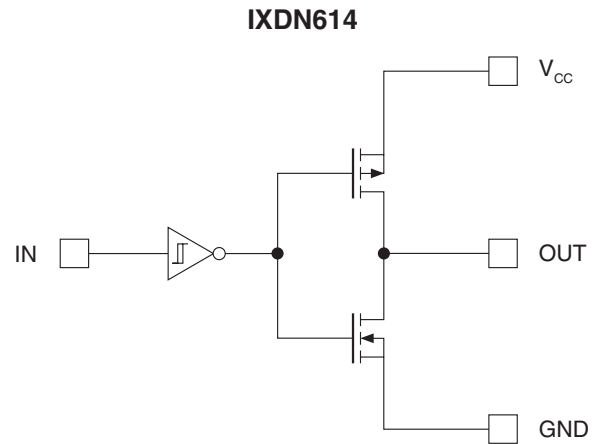

IN	OUT
0	0
1	1

2.2 IXDI614 Block Diagram & Truth Table

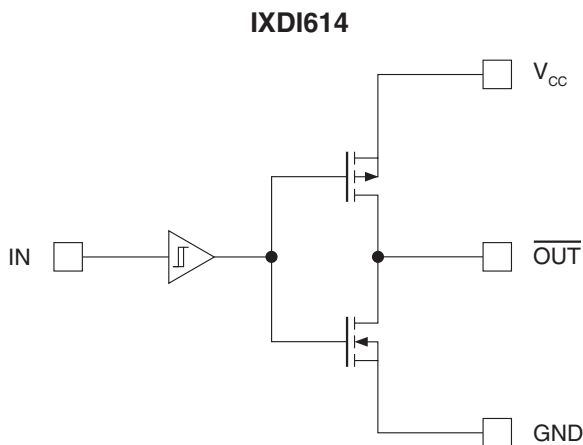

IN	OUT
0	1
1	0

2.4 Timing Diagrams

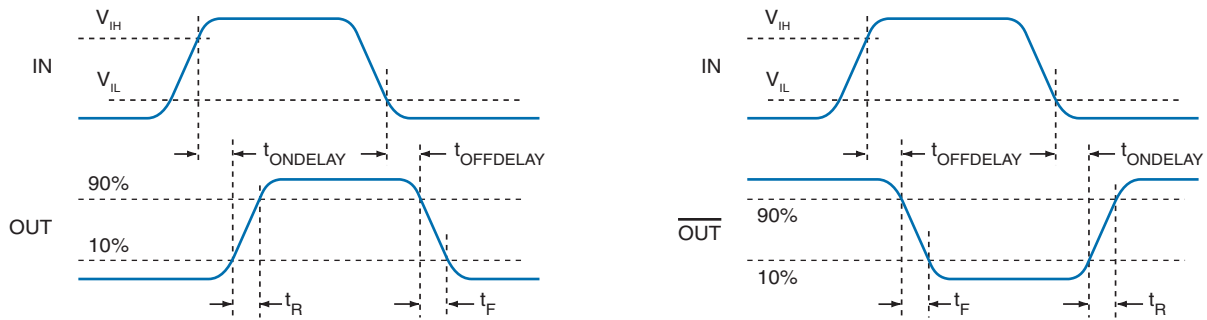

2.5 Characteristics Test Diagram

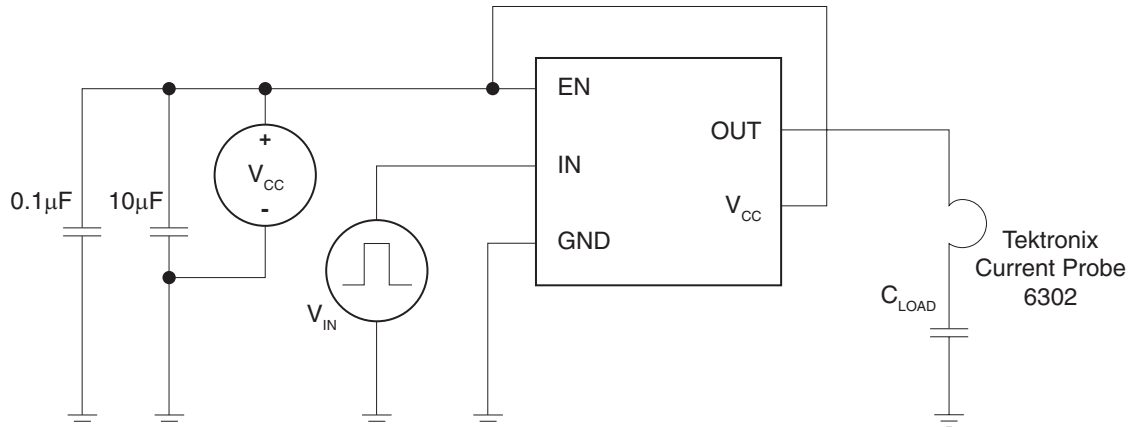

3 Performance Data

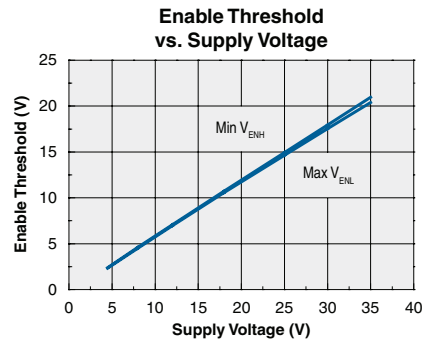
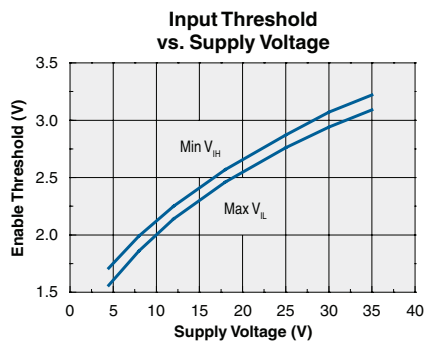
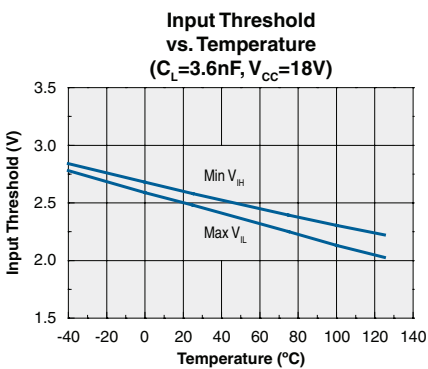
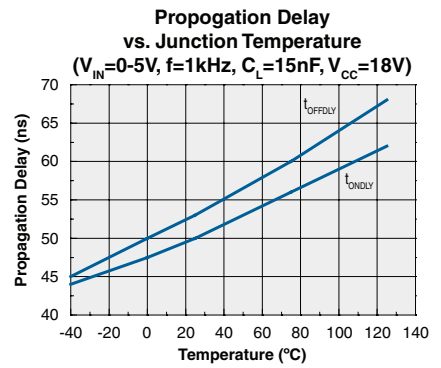
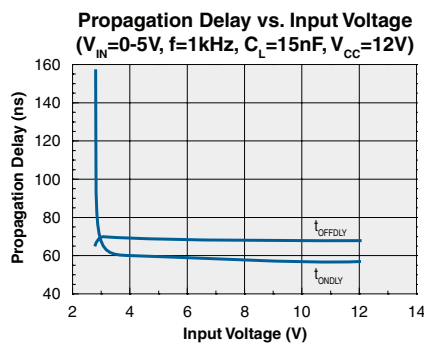
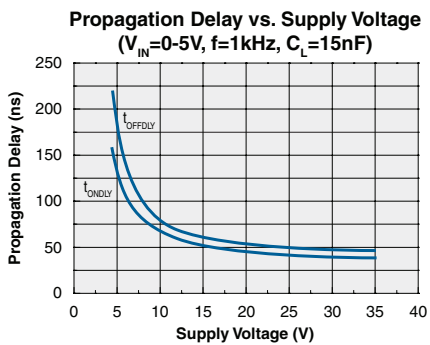
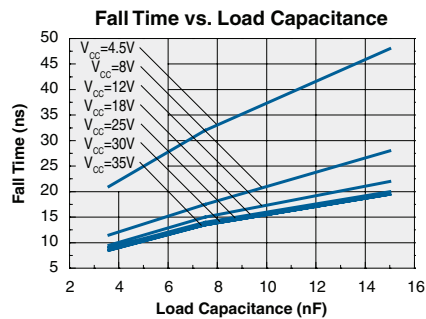
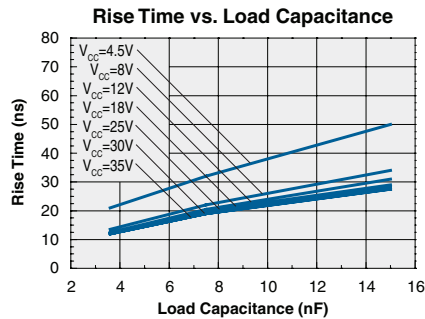
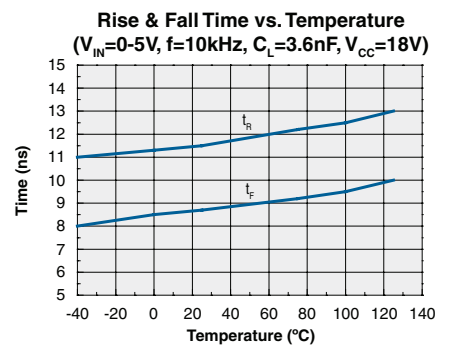
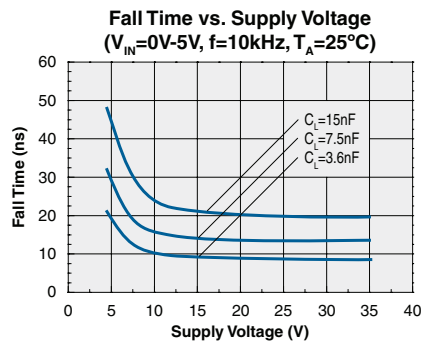
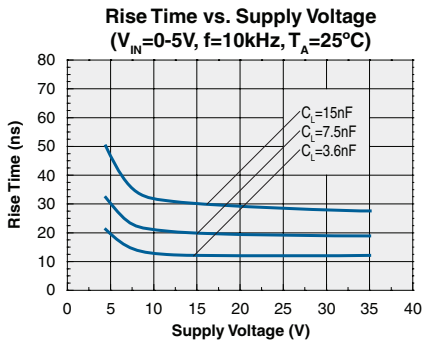

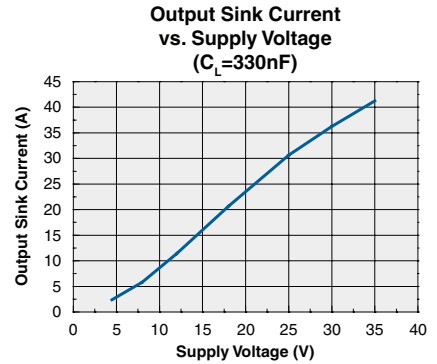
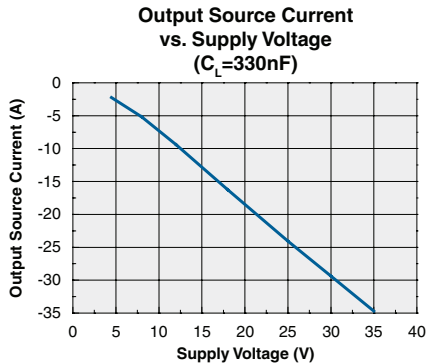
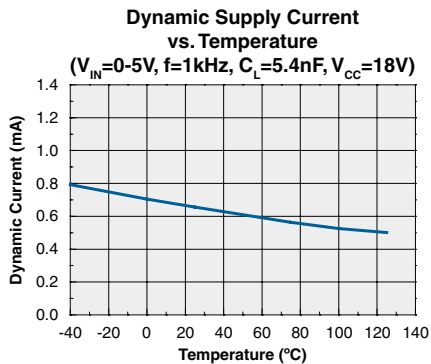
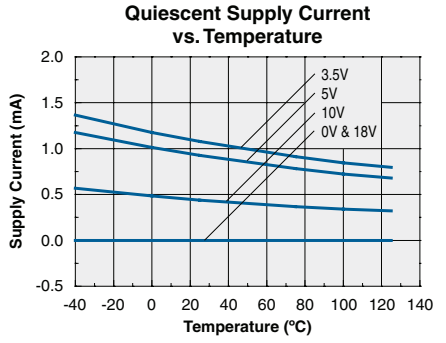
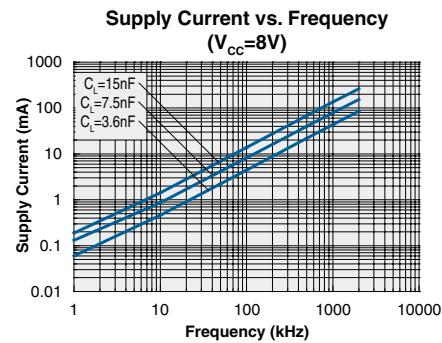
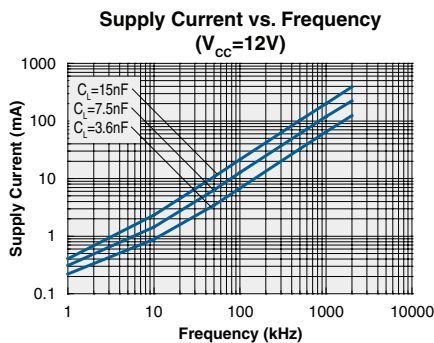
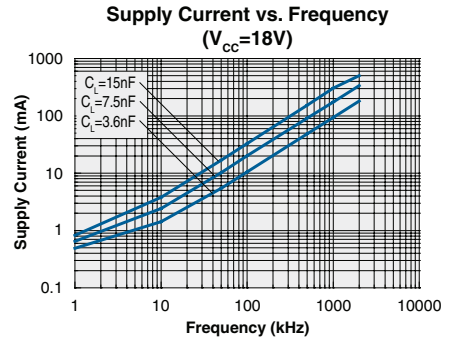
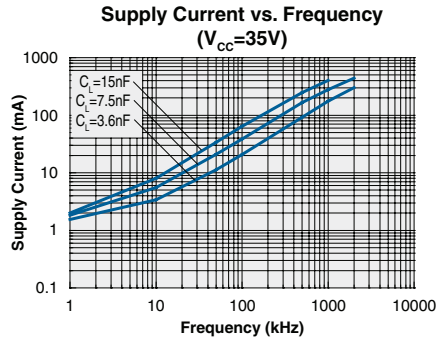
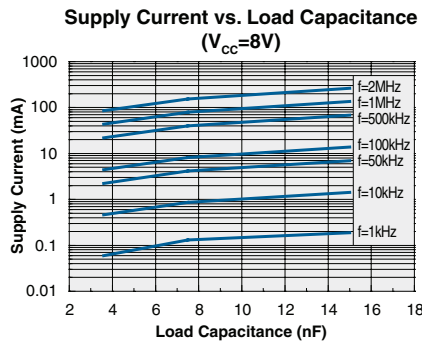
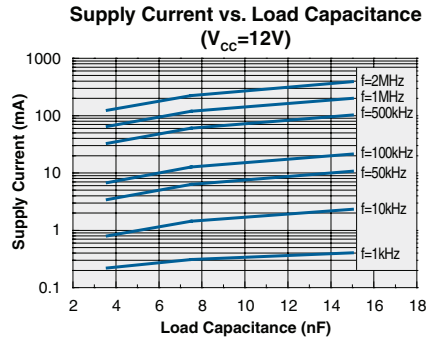
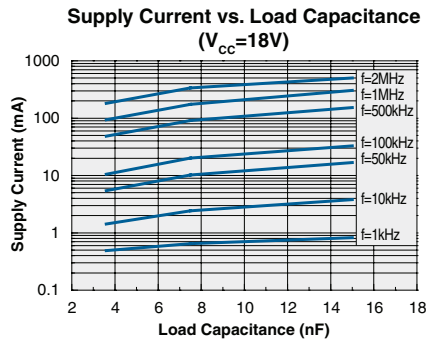
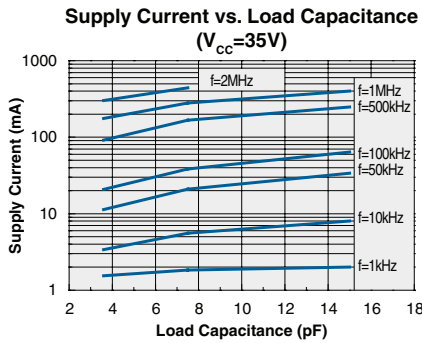

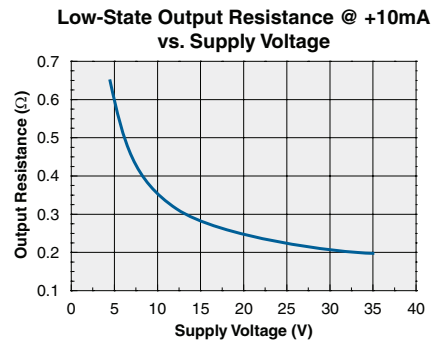
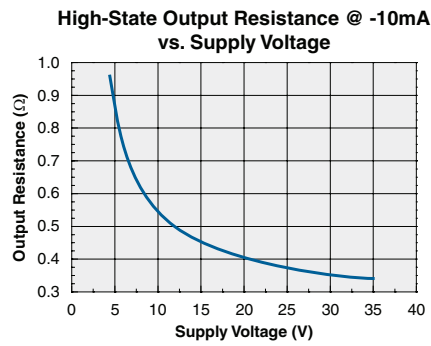
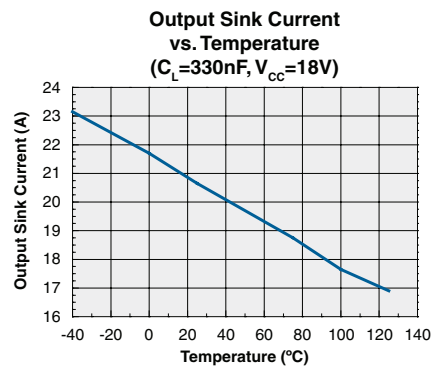
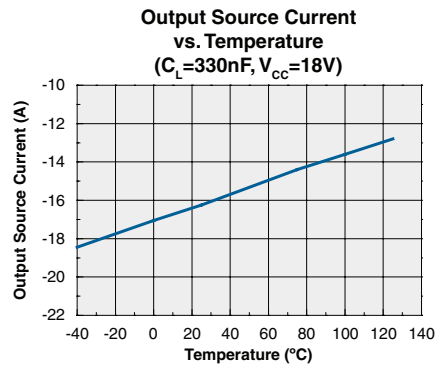

4 Manufacturing Information

4.1 Mechanical Dimensions

4.1.1 SI (8-Lead Power SOIC with Exposed Metal Back)

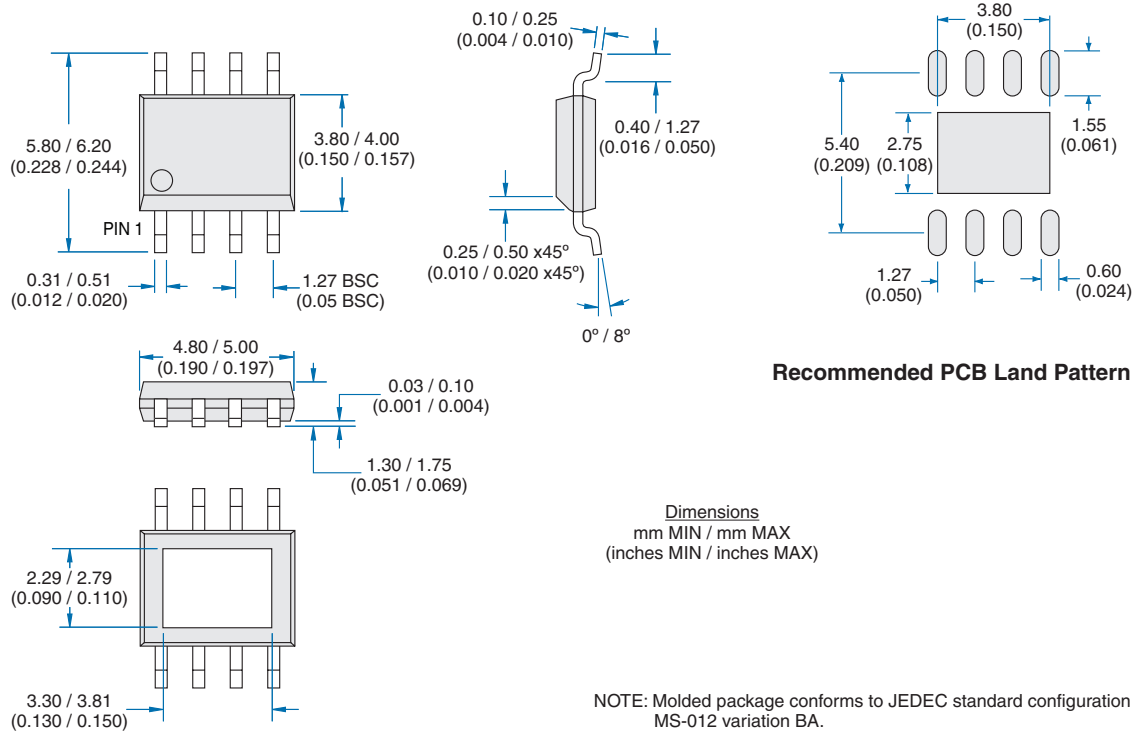

4.1.2 YI (5-Lead TO-263)

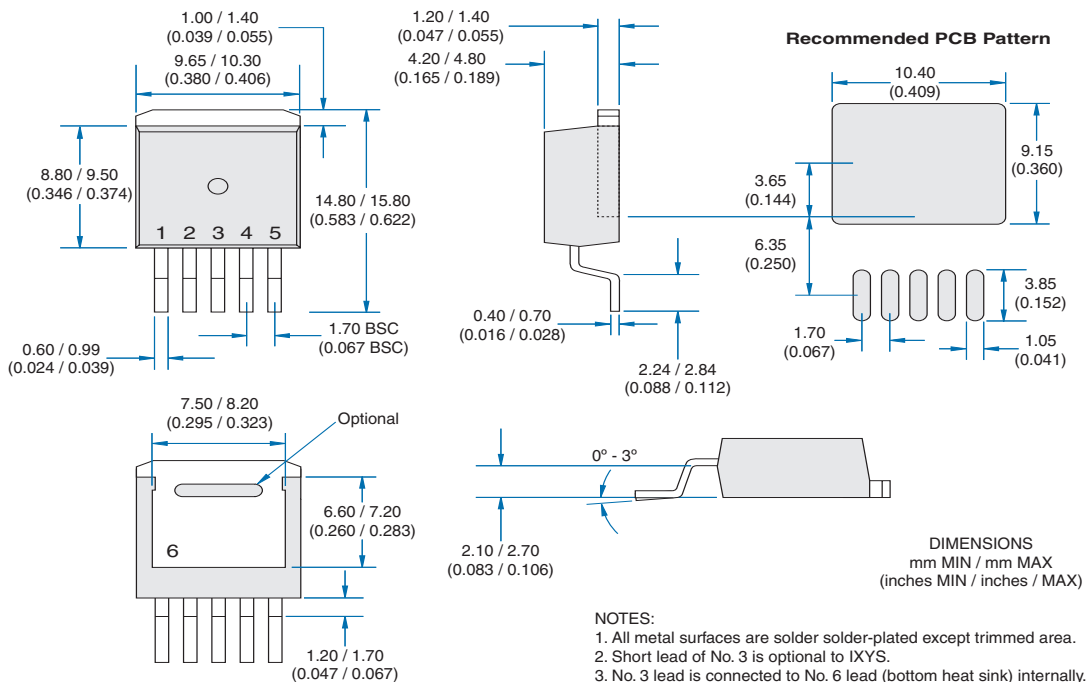

4.1.3 CI (5-Pin TO-220)

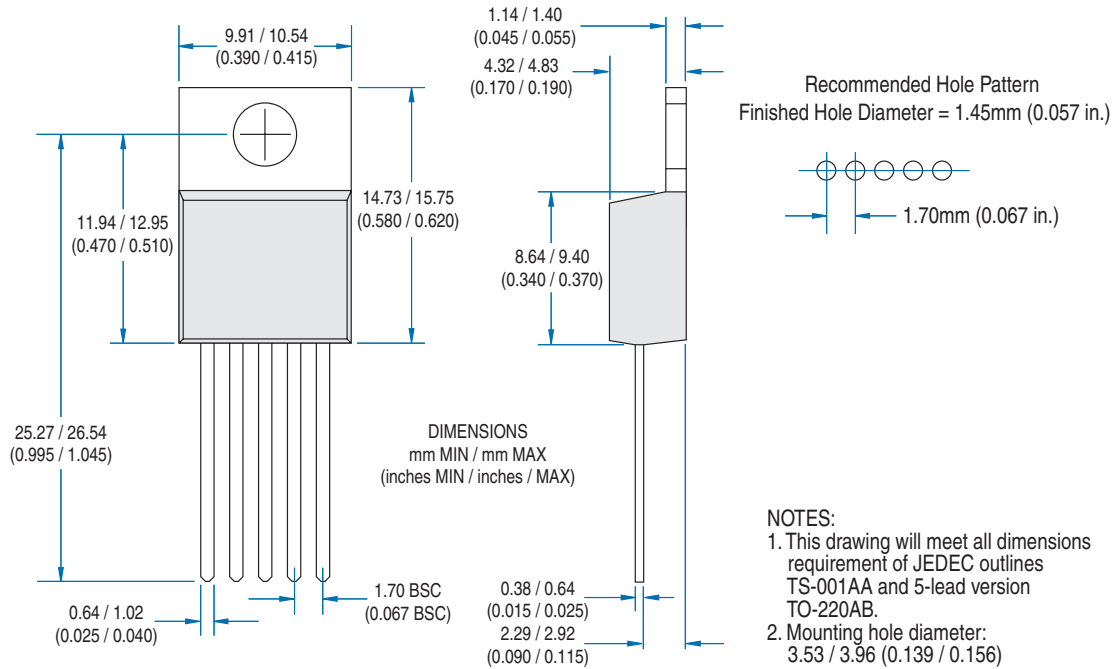

4.1.4 PI (8-Pin DIP)

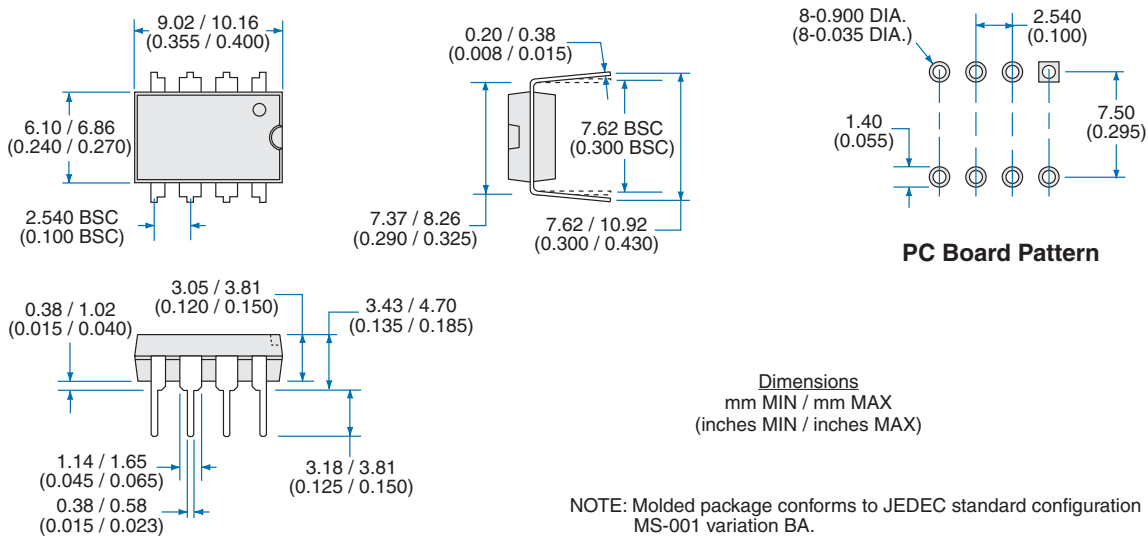

For additional information please visit our website at: www.clare.com

Clare, Inc. makes no representations or warranties with respect to the accuracy or completeness of the contents of this publication and reserves the right to make changes to specifications and product descriptions at any time without notice. Neither circuit patent licenses nor indemnity are expressed or implied. Except as set forth in Clare's Standard Terms and Conditions of Sale, Clare, Inc. assumes no liability whatsoever, and disclaims any express or implied warranty, relating to its products including, but not limited to, the implied warranty of merchantability, fitness for a particular purpose, or infringement of any intellectual property right.

The products described in this document are not designed, intended, authorized or warranted for use as components in systems intended for surgical implant into the body, or in other applications intended to support or sustain life, or where malfunction of Clare's product may result in direct physical harm, injury, or death to a person or severe property or environmental damage. Clare, Inc. reserves the right to discontinue or make changes to its products at any time without notice.

Specification: DS-IXD_614-R00J
©Copyright 2010, Clare, Inc.
All rights reserved. Printed in USA.
9/20/2010