

TOSHIBA BIPOLAR DIGITAL INTEGRATED CIRCUIT SILICON MONOLITHIC

TD62781AP, TD62781F, TD62781AF
TD62782AP, TD62782F, TD62782AF

8CH HIGH-VOLTAGE SOURCE DRIVER

The TD62781AP/F/AF Series are comprised of eight source current Transistor Array. These drivers are specifically designed for fluorescent display applications. Applications include relay, hammer and lamp drivers.

FEATURES

- High output voltage Type-AP, AF : $V_{OUT} = 60V$ (Min.)
 Type-F : $V_{OUT} = 35V$ (Min.)
- Output current (single output) $I_{OUT} = -50mA / ch$ (Max.)
- Pull-down resistors / each output
- Single supply voltage
- Input compatible with various types of logic

TYPE	DESIGNATION
TD62781AP/F/AF	TTL, 5V CMOS
TD62782AP/F/AF	6~15V PMOS CMOS

PIN CONNECTION (TOP VIEW)

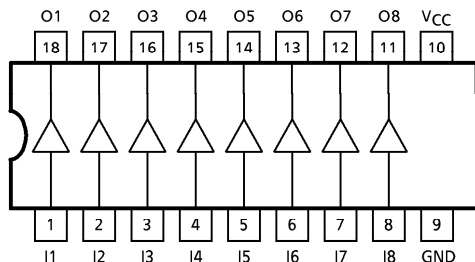

SCHEMATICS (EACH DRIVER)

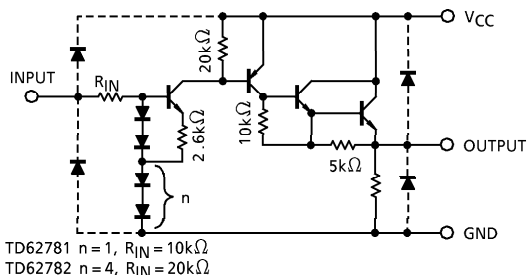

(Note) The input and output parasitic diodes cannot be used as clamp diodes.

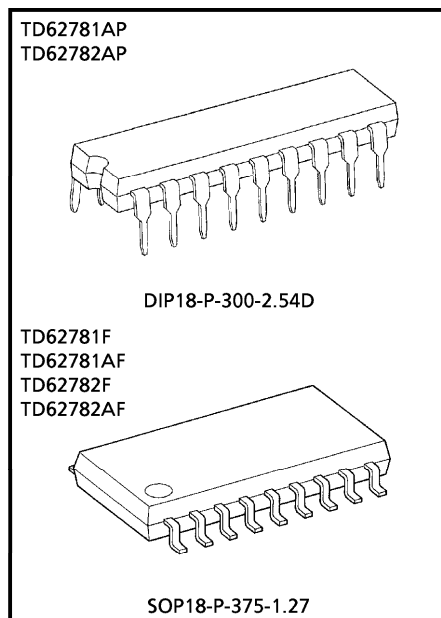

Weight
 DIP18-P-300-2.54D : 1.47g (Typ.)
 SOP18-P-375-1.27 : 0.41g (Typ.)

961001EBA2

● TOSHIBA is continually working to improve the quality and the reliability of its products. Nevertheless, semiconductor devices in general can malfunction or fail due to their inherent electrical sensitivity and vulnerability to physical stress. It is the responsibility of the buyer, when utilizing TOSHIBA products, to observe standards of safety, and to avoid situations in which a malfunction or failure of a TOSHIBA product could cause loss of human life, bodily injury or damage to property. In developing your designs, please ensure that TOSHIBA products are used within specified operating ranges as set forth in the most recent products specifications. Also, please keep in mind the precautions and conditions set forth in the TOSHIBA Semiconductor Reliability Handbook.

MAXIMUM RATINGS (Ta = 25°C)

CHARACTERISTIC		SYMBOL	RATING	UNIT
Supply Voltage	AP/AF	V _{CC}	60	V
	F		35	
Output Voltage		V _{OUT}	V _{CC}	V
Output Current		I _{OUT}	- 50	mA / ch
Input Voltage		V _{IN}	20	V
Power Dissipation	AP	P _D (Note)	1.47	W
	F/AF		0.96	
Operating Temperature		T _{opr}	- 40~85	°C
Storage Temperature		T _{stg}	- 55~150	°C

(Note) Delated above 25°C in the proportion 11.7mW/°C (AP Type), 7.7mW/°C (F, AF Type).

RECOMMENDED OPERATING CONDITIONS (Ta = - 40~85°C)

CHARACTERISTIC		SYMBOL	CONDITION	MIN.	TYP.	MAX.	UNIT
Supply Voltage	TD62781AP, TD62781AF	V _{CC}	—	4.5	—	55	V
	TD62781F			4.5	—	35	
	TD62782AP, TD62782AF			6.0	—	55	
	TD62782F			6.0	—	35	
Output Voltage		V _{OUT}	—	0	—	V _{CC}	V
Output Current		I _{OUT}	—	0	—	- 40	mA / ch
Input Voltage	TD62781	V _{IN}	—	0	—	7	V
	TD62782			0	—	15	
Power Dissipation	AP	P _D	—	—	—	0.52	W
	AF/F			—	—	0.35	

ELECTRICAL CHARACTERISTICS (Ta = 25°C)

CHARACTERISTIC		SYMBOL	TEST CIRCUIT	TEST CONDITION	MIN.	TYP.	MAX.	UNIT
Input Voltage	"H" Level	TD62781	V _{IH}	1	—	2.0	—	V
		TD62782						
Input Voltage	"L" Level	TD62781	V _{IL}	1	—	0	—	V
		TD62782						
Input Current	"H" Level	TD62781	I _{IH}	2	V _{IN} = 2.4V	—	40	75
		TD62782			V _{IN} = 7.5V	—	170	250
Output Current	"H" Level	I _{OL}	3	—	—	200	—	μA
Output Voltage	"H" Level	V _{OH}	4	I _{OUT} = - 40mA, V _{IN} = V _{IH} MIN.	V _{CC} - 2.5	V _{CC} - 1.7	—	V
	"L" Level	V _{OL}		I _{OUT} = 0, V _{IN} = V _{IL} MIN.	—	50	250	mV
Supply Current	I _{CC} (ON)		1	V _{CC} = 55V, V _{IN} = V _{IH} MIN. (*)	—	—	20	mA
	I _{CC} (OFF)			V _{CC} = 55V, V _{IN} = V _{IL} MAX. (*)	—	—	1	
Turn-On Delay	t _{ON}		5	V _{CC} = 55V, C _L = 15pF (*)	—	0.2	—	μs
Turn-Off Delay	t _{OFF}				—	6.0	—	

(*) V_{CC} = 35V for Type-F

961001EBA2

- The products described in this document are subject to foreign exchange and foreign trade control laws.
- The information contained herein is presented only as a guide for the applications of our products. No responsibility is assumed by TOSHIBA CORPORATION for any infringements of intellectual property or other rights of the third parties which may result from its use. No license is granted by implication or otherwise under any intellectual property or other rights of TOSHIBA CORPORATION or others.
- The information contained herein is subject to change without notice.

TEST CIRCUIT

1. V_{IH} , V_{IL} , I_{CC}

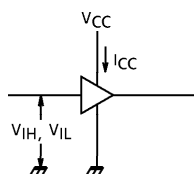

2. I_{IH}

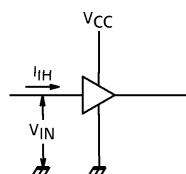

3. I_{OL}

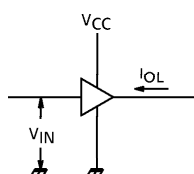

4. V_{OH} , V_{OL}

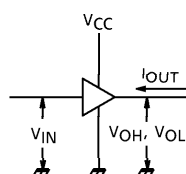

5. t_{ON} , t_{OFF}

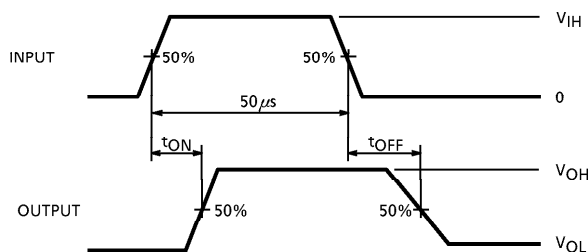
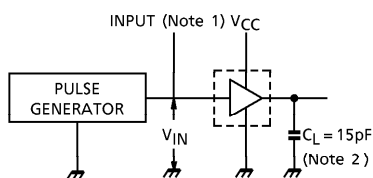

- (Note 1) Pulse Width $50\mu s$, Duty Cycle 10%
Output Impedance 50Ω , $t_r \leq 100ns$, $t_f \leq 100ns$
- (Note 2) C_L includes probe and jig capacitance.

PRECAUTIONS for USING

Utmost care is necessary in the design of the output line, V_{CC} and GND line since IC may be destroyed due to short-circuit between outputs, air contamination fault, or fault by improper grounding.

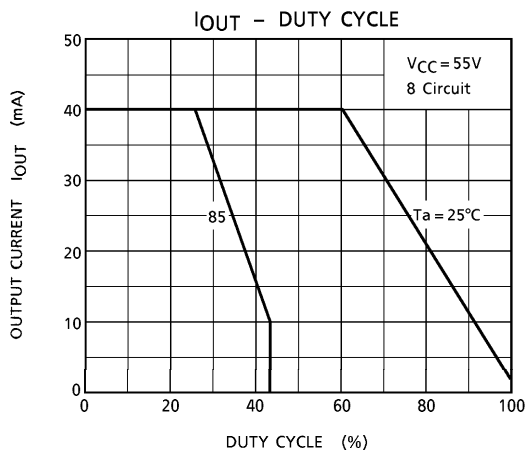
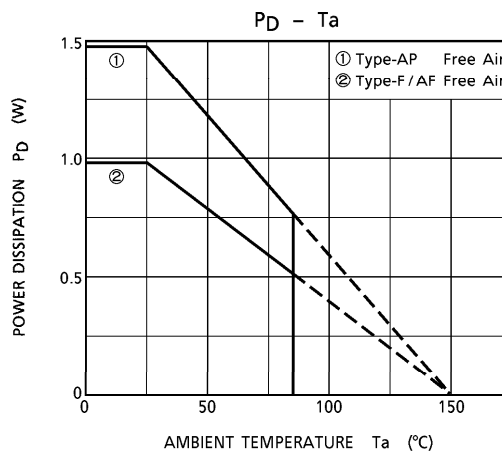
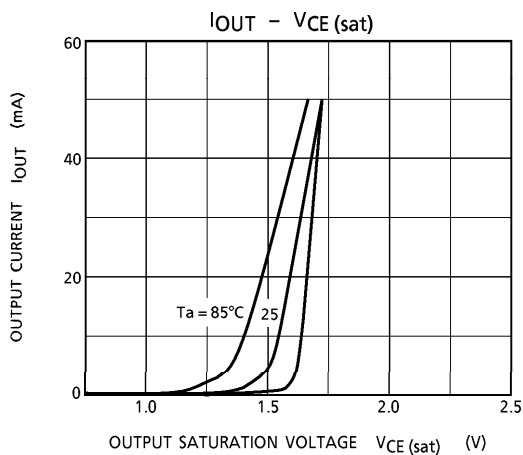
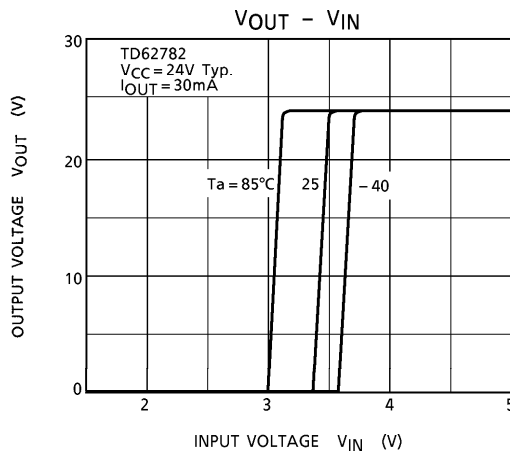
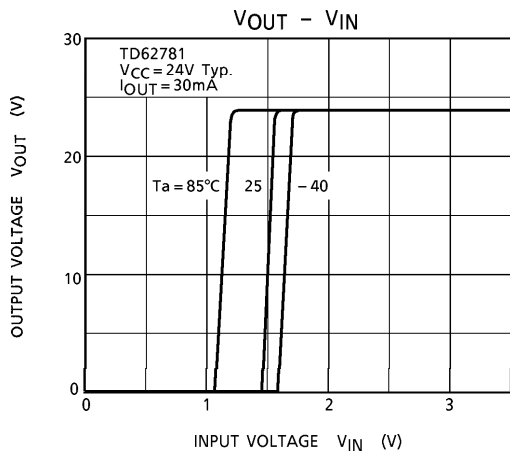

OUTLINE DRAWING
DIP18-P-300-2.54D

Unit : mm

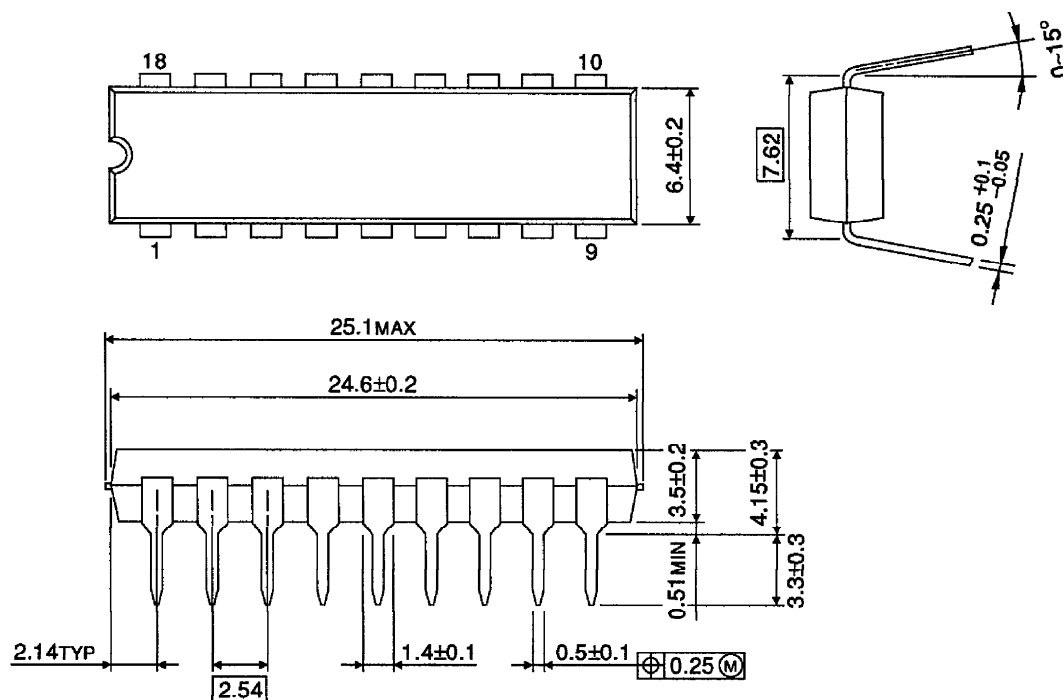

Weight : 1.47g (Typ.)

OUTLINE DRAWING
SOP18-P-375-1.27

Unit : mm

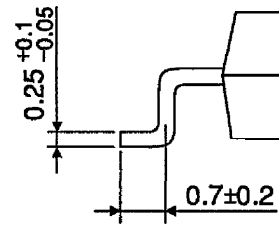
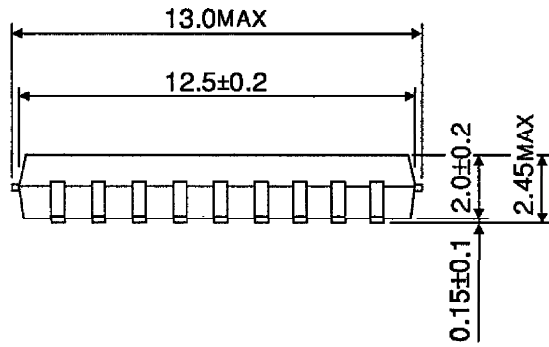
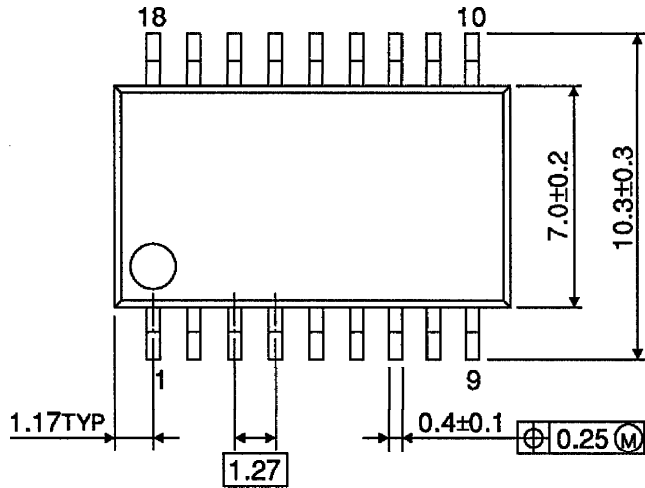

Weight : 0.41g (Typ.)