

RF Power Field Effect Transistors

N-Channel Enhancement-Mode Lateral MOSFETs

Designed for W-CDMA base station applications with frequencies from 2110 to 2170 MHz. Suitable for TDMA, CDMA and multicarrier amplifier applications. To be used in Class AB for PCN - PCS/cellular radio and WLL applications.

- Typical 2-carrier W-CDMA Performance: $V_{DD} = 28$ Volts, $I_{DQ} = 1050$ mA, $P_{out} = 23$ Watts Avg., Full Frequency Band, Channel Bandwidth = 3.84 MHz, PAR = 8.5 dB @ 0.01% Probability on CCDF.
 Power Gain — 13.5 dB
 Drain Efficiency — 26%
 IM3 @ 10 MHz Offset — -37 dBc in 3.84 MHz Channel Bandwidth
 ACPR @ 5 MHz Offset — -40 dBc in 3.84 MHz Channel Bandwidth
- Capable of Handling 10:1 VSWR, @ 28 Vdc, 2140 MHz, 100 Watts CW Output Power

Features

- Characterized with Series Equivalent Large-Signal Impedance Parameters
- Internally Matched for Ease of Use
- Qualified Up to a Maximum of 32 V_{DD} Operation
- Integrated ESD Protection
- Lower Thermal Resistance Package
- Low Gold Plating Thickness on Leads, 40 μ m Nominal.
- RoHS Compliant
- In Tape and Reel. R3 Suffix = 250 Units per 56 mm, 13 inch Reel.

MRF5S21100HR3
MRF5S21100HSR3

2110-2170 MHz, 23 W AVG., 28 V
2 x W-CDMA
LATERAL N-CHANNEL
RF POWER MOSFETs

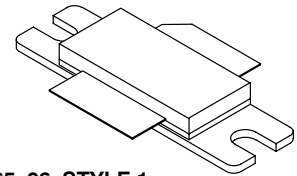

CASE 465-06, STYLE 1
NI-780
MRF5S21100HR3

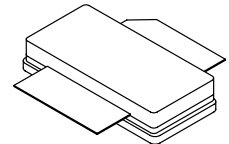

CASE 465A-06, STYLE 1
NI-780S
MRF5S21100HSR3

Table 1. Maximum Ratings

Rating	Symbol	Value	Unit
Drain-Source Voltage	V_{DSS}	-0.5, +65	Vdc
Gate-Source Voltage	V_{GS}	-0.5, +15	Vdc
Total Device Dissipation @ $T_C = 25^\circ\text{C}$ Derate above 25 $^\circ\text{C}$	P_D	273 1.56	W W/ $^\circ\text{C}$
Storage Temperature Range	T_{stg}	-65 to +150	$^\circ\text{C}$
Case Operating Temperature	T_C	150	$^\circ\text{C}$
Operating Junction Temperature	T_J	200	$^\circ\text{C}$

Table 2. Thermal Characteristics

Characteristic	Symbol	Value (1,2)	Unit
Thermal Resistance, Junction to Case Case Temperature 80 $^\circ\text{C}$, 100 W CW Case Temperature 78 $^\circ\text{C}$, 23 W CW	$R_{\theta JC}$	0.57 0.64	$^\circ\text{C}/\text{W}$

1. MTF calculator available at <http://www.freescale.com/rtf>. Select Tools/Software/Application Software/Calculators to access the MTF calculators by product.
2. Refer to AN1955, *Thermal Measurement Methodology of RF Power Amplifiers*. Go to <http://www.freescale.com/rtf>. Select Documentation/Application Notes - AN1955.

Table 3. ESD Protection Characteristics

Test Conditions	Class
Human Body Model	2 (Minimum)
Machine Model	M3 (Minimum)
Charge Device Model	C7 (Minimum)

Table 4. Electrical Characteristics ($T_C = 25^\circ\text{C}$ unless otherwise noted)

Characteristic	Symbol	Min	Typ	Max	Unit
Off Characteristics					
Zero Gate Voltage Drain Leakage Current ($V_{DS} = 65\text{ Vdc}$, $V_{GS} = 0\text{ Vdc}$)	I_{DSS}	—	—	10	μAdc
Zero Gate Voltage Drain Leakage Current ($V_{DS} = 28\text{ Vdc}$, $V_{GS} = 0\text{ Vdc}$)	I_{DSS}	—	—	1	μAdc
Gate-Source Leakage Current ($V_{GS} = 5\text{ Vdc}$, $V_{DS} = 0\text{ Vdc}$)	I_{GSS}	—	—	0.5	μAdc

On Characteristics (DC)

Gate Threshold Voltage ($V_{DS} = 10\text{ Vdc}$, $I_D = 250\ \mu\text{Adc}$)	$V_{GS(th)}$	2.5	2.8	3.5	Vdc
Gate Quiescent Voltage ($V_{DS} = 28\text{ Vdc}$, $I_D = 1050\text{ mAdc}$)	$V_{GS(Q)}$	—	3.8	—	Vdc
Drain-Source On-Voltage ($V_{GS} = 10\text{ Vdc}$, $I_D = 2.5\text{ Adc}$)	$V_{DS(on)}$	—	0.24	0.3	Vdc
Forward Transconductance ($V_{DS} = 10\text{ Vdc}$, $I_D = 2.5\text{ Adc}$)	g_{fs}	—	6	—	S

Dynamic Characteristics (1)

Reverse Transfer Capacitance ($V_{DS} = 28\text{ Vdc} \pm 30\text{ mV(rms)ac}$ @ 1 MHz, $V_{GS} = 0\text{ Vdc}$)	C_{rss}	—	2.14	—	pF
---	-----------	---	------	---	----

Functional Tests (In Freescale Test Fixture, 50 ohm system) $V_{DD} = 28\text{ Vdc}$, $I_{DQ} = 1050\text{ mA}$, $P_{out} = 23\text{ W Avg.}$, $f_1 = 2112.5\text{ MHz}$, $f_2 = 2122.5\text{ MHz}$ and $f_1 = 2157.5\text{ MHz}$, $f_2 = 2167.5\text{ MHz}$, 2-carrier W-CDMA, 3.84 MHz Channel Bandwidth Carriers. ACPR measured in 3.84 MHz Channel Bandwidth @ $\pm 5\text{ MHz}$ Offset. IM3 measured in 3.84 MHz Bandwidth @ $\pm 10\text{ MHz}$ Offset. PAR = 8.5 dB @ 0.01% Probability on CCDF.

Power Gain	G_{ps}	12.5	13.5	—	dB
Drain Efficiency	η_D	24	26	—	%
Intermodulation Distortion	IM3	—	-37	-35	dBc
Adjacent Channel Power Ratio	ACPR	—	-40	-38	dBc
Input Return Loss	IRL	—	-16	-9	dB

1. Part is internally matched both on input and output.

查询"MRF5S21100H"供应商

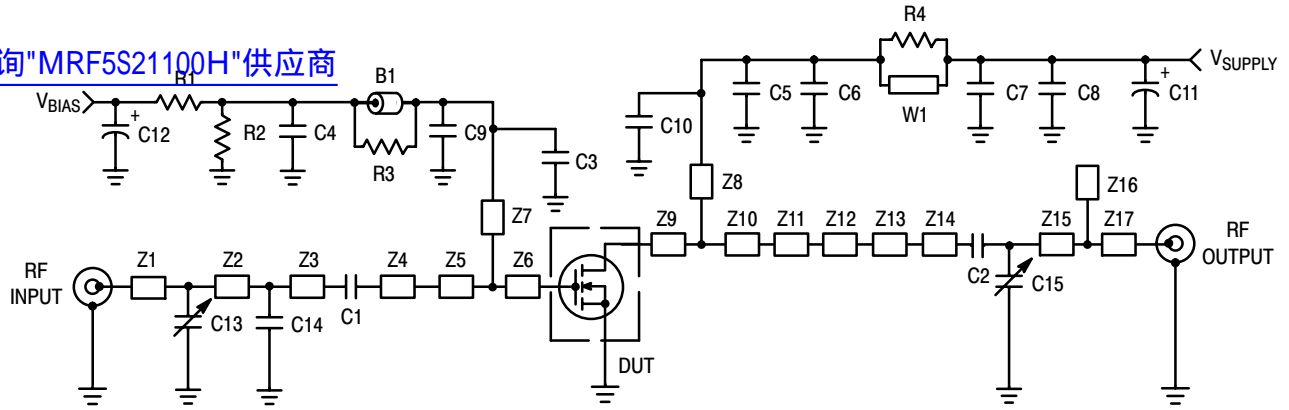

Z1	0.674" x 0.080" Microstrip	Z10	0.368" x 1.136" Microstrip
Z2	0.421" x 0.080" Microstrip	Z11	0.151" x 0.393" Microstrip
Z3	0.140" x 0.080" Microstrip	Z12	0.280" x 0.220" Microstrip
Z4	1.031" x 0.080" Microstrip	Z13	0.481" x 0.142" Microstrip
Z5	0.380" x 0.643" Microstrip	Z14	0.138" x 0.080" Microstrip
Z6	0.080" x 0.643" Microstrip	Z15	0.344" x 0.080" Microstrip
Z7	0.927" x 0.048" Microstrip	Z16	0.147" x 0.099" Microstrip
Z8	0.620" x 0.048" Microstrip	Z17	0.859" x 0.080" Microstrip
Z9	0.079" x 1.136" Microstrip	PCB	Arlon GX-0300-SS-22, 0.030", $\epsilon_r = 2.55$

Figure 1. MRF5S21100HR3(SR3) Test Circuit Schematic

Table 5. MRF5S21100HR3(SR3) Test Circuit Component Designations and Values

Part	Description	Part Number	Manufacturer
B1	Short RF Bead	95F786	Newark
C1, C2	8.2 pF Chip Capacitors	100B8R2CP500X	ATC
C3	5.6 pF Chip Capacitor	100B5R6CP500X	ATC
C4	0.1 μ F Chip Capacitor	C1210C104J5RAC	Kemet
C5, C7	7.5 pF Chip Capacitors	100B7R5JP500X	ATC
C6	1.2 pF Chip Capacitor	100B1R2BP500X	ATC
C8	1K pF Chip Capacitor	100B102JP500X	ATC
C9, C10	0.56 μ F Chip Capacitors	C1825C564J5RAC	Kemet
C11	470 μ F, 63 V Electrolytic Capacitor	95F4579	Newark
C12	100 μ F, 50 V Electrolytic Capacitor	51F2913	Newark
C13	0.6 - 4.5 pF Gigatrim Variable Capacitor	44F3358	Newark
C14	2.7 pF Chip Capacitor	100B2R7CP500X	ATC
C15	0.4 - 2.5 pF Gigatrim Variable Capacitor	44F3367	Newark
R1	1 k Ω Chip Resistor	D5534M07B1K00R	Newark
R2	560 k Ω Chip Resistor	CR1206564JT	Newark
R3, R4	12 Ω Chip Resistors	RM73B2B120JT	Garrett Electronics

MRF5S21100HR3 MRF5S21100HSR3

[查询"MRF5S21100H"供应商](#)

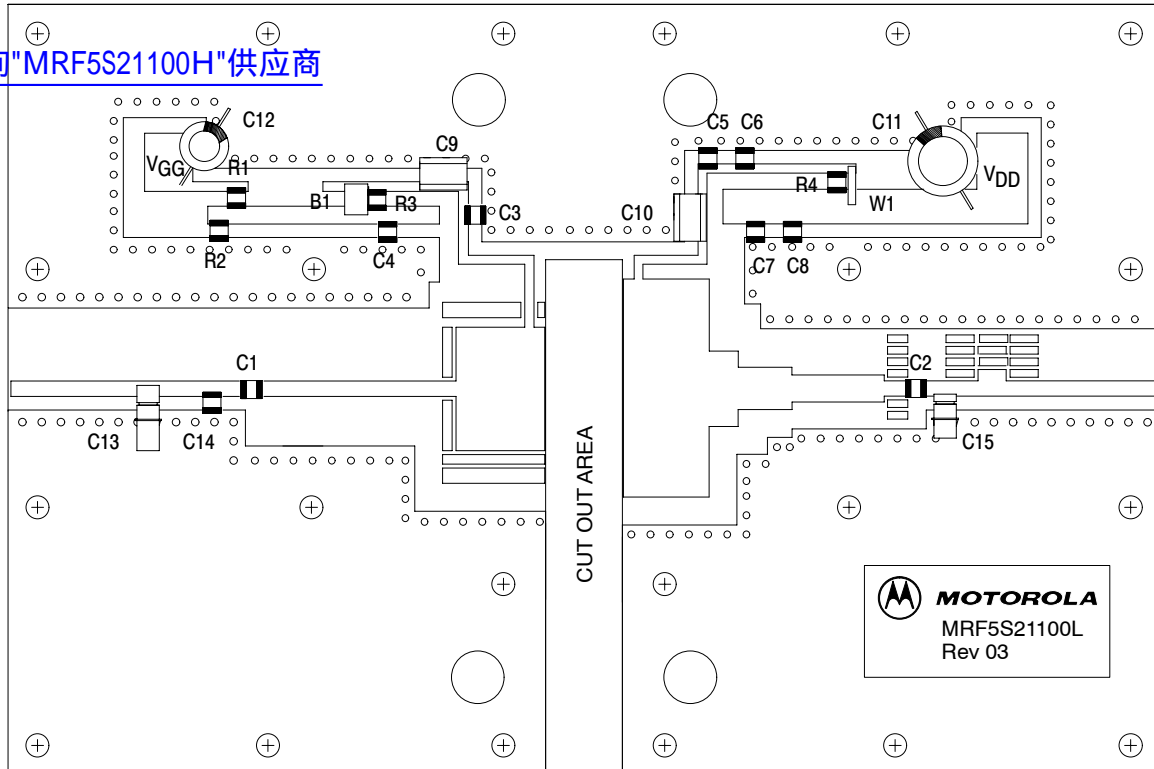

Freescall has begun the transition of marking Printed Circuit Boards (PCBs) with the Freescall Semiconductor signature/logo. PCBs may have either Motorola or Freescall markings during the transition period. These changes will have no impact on form, fit or function of the current product.

Figure 2. MRF5S21100HR3(SR3) Test Circuit Component Layout

TYPICAL CHARACTERISTICS

查询"MRF5S21100H"供应商

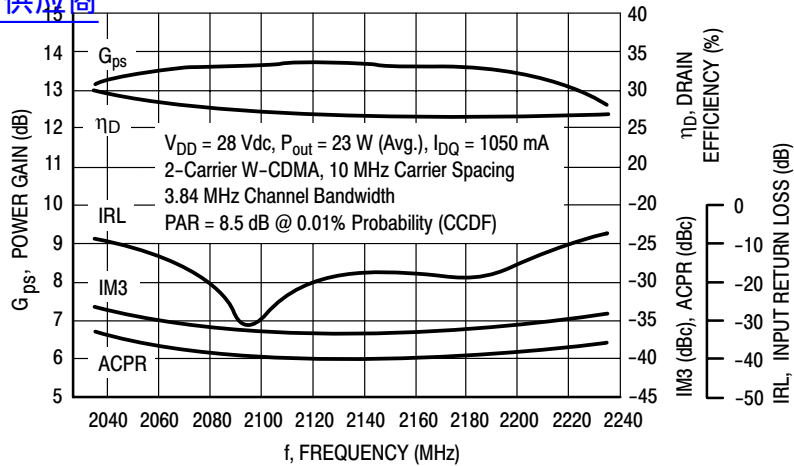

Figure 3. 2-Carrier W-CDMA Broadband Performance

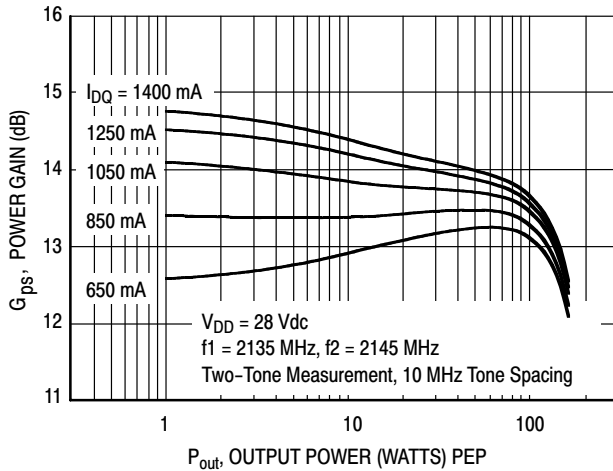

Figure 4. Two-Tone Power Gain versus Output Power

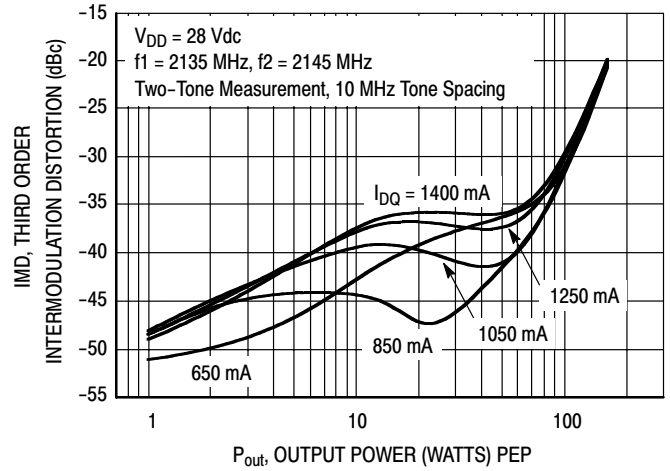

Figure 5. Third Order Intermodulation Distortion versus Output Power

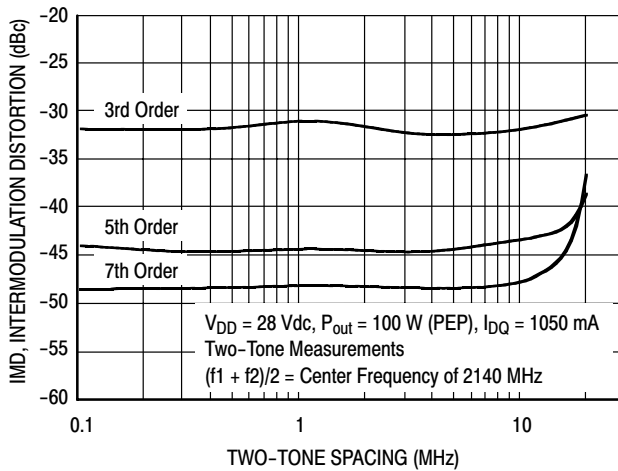

Figure 6. Intermodulation Distortion Products versus Tone Spacing

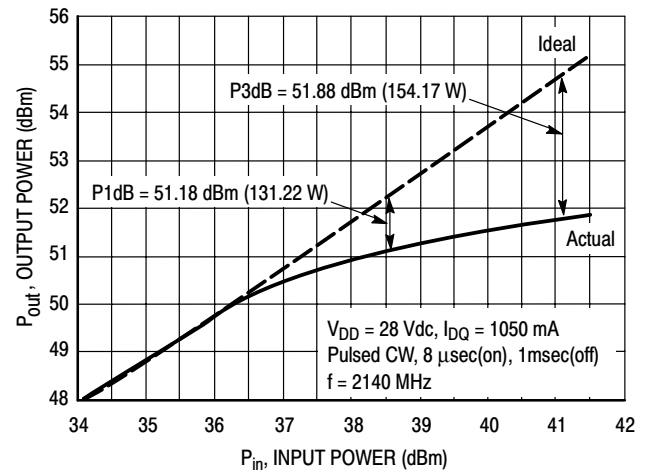

Figure 7. Pulse CW Output Power versus Input Power

MRF5S21100HR3 MRF5S21100HSR3

TYPICAL CHARACTERISTICS

[查询"MRF5S21100H"供应商](#)

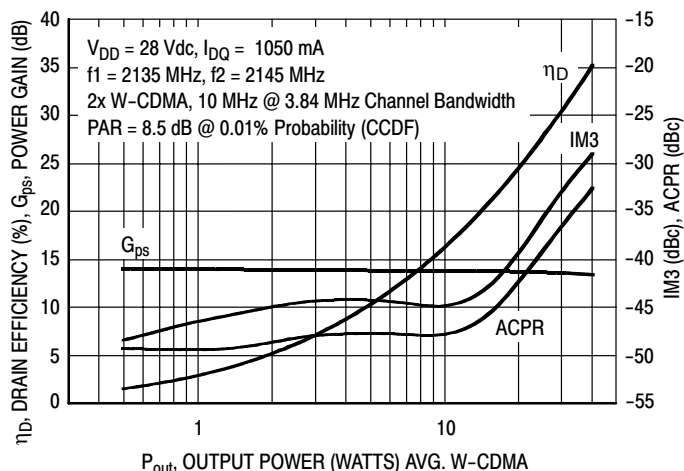
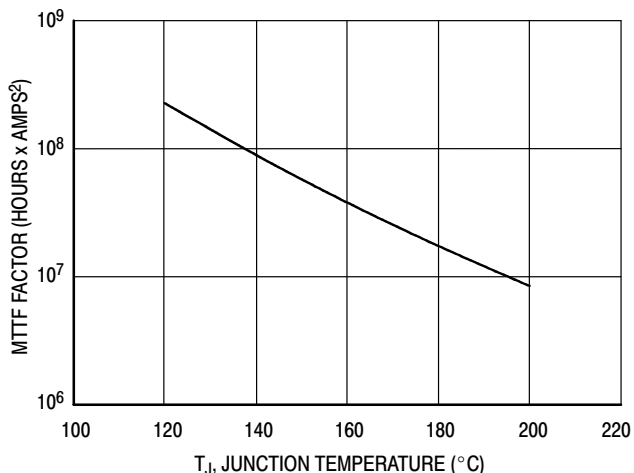

Figure 8. 2-Carrier W-CDMA ACPR, IM3, Power Gain and Drain Efficiency versus Output Power



This above graph displays calculated MTTF in hours x ampere² drain current. Life tests at elevated temperatures have correlated to better than $\pm 10\%$ of the theoretical prediction for metal failure. Divide MTTF factor by I_D^2 for MTTF in a particular application.

Figure 9. MTTF Factor versus Junction Temperature

W-CDMA TEST SIGNAL

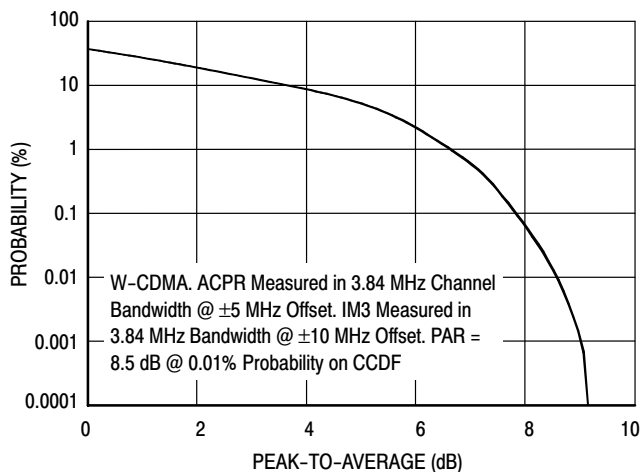

Figure 10. CCDF W-CDMA 3GPP, Test Model 1, 64 DPCH, 67% Clipping, Single Carrier Test Signal

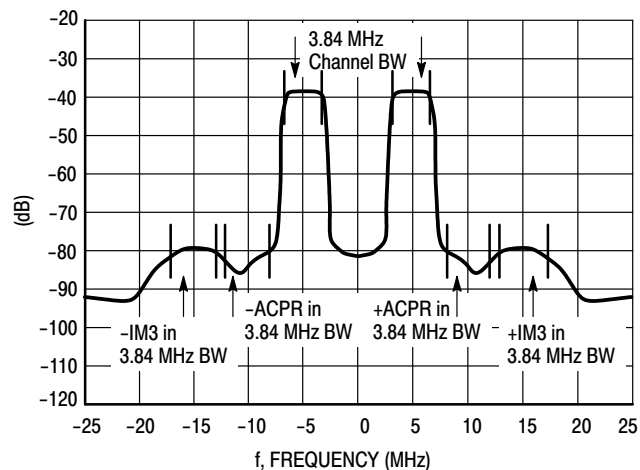
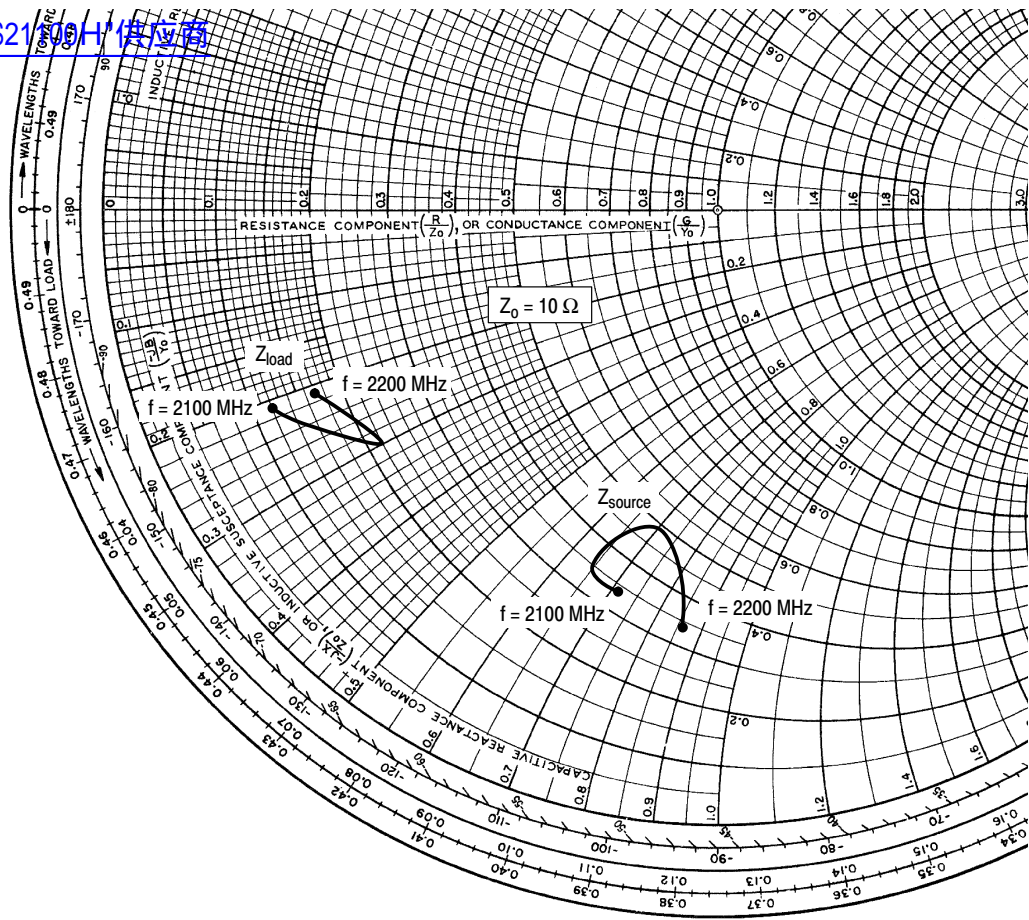

Figure 11. 2-Carrier W-CDMA Spectrum



$V_{DD} = 28 \text{ Vdc}$, $I_{DQ} = 1050 \text{ mA}$, $P_{out} = 23 \text{ W Avg.}$

f MHz	Z_{source} Ω	Z_{load} Ω
2100	$3.4 - j7.2$	$1.2 - j2.1$
2120	$3.4 - j6.5$	$1.4 - j2.3$
2160	$4.9 - j7.0$	$2.2 - j3.0$
2200	$3.4 - j8.6$	$1.7 - j2.1$

Z_{source} = Test circuit impedance as measured from gate to ground.

Z_{load} = Test circuit impedance as measured from drain to ground.

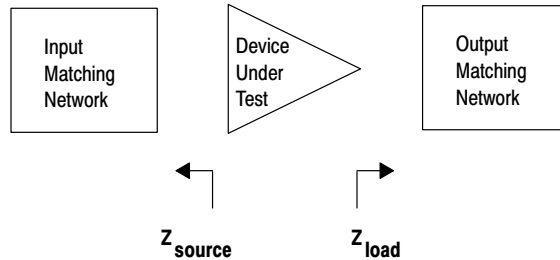

Figure 12. Series Equivalent Source and Load Impedance

NOTES

[查询"MRF5S21100H"供应商](#)

NOTES

[查询"MRF5S21100H"供应商](#)

NOTES

[查询"MRF5S21100H"供应商](#)

[查询"MRF5S21100H"供应商](#)

How to Reach Us:

Home Page:
www.freescale.com

E-mail:
support@freescale.com

USA/Europe or Locations Not Listed:
Freescale Semiconductor
Technical Information Center, CH370
1300 N. Alma School Road
Chandler, Arizona 85224
+1-800-521-6274 or +1-480-768-2130
support@freescale.com

Europe, Middle East, and Africa:
Freescale Halbleiter Deutschland GmbH
Technical Information Center
Schatzbogen 7
81829 Muenchen, Germany
+44 1296 380 456 (English)
+46 8 52200080 (English)
+49 89 92103 559 (German)
+33 1 69 35 48 48 (French)
support@freescale.com

Japan:
Freescale Semiconductor Japan Ltd.
Headquarters
ARCO Tower 15F
1-8-1, Shimo-Meguro, Meguro-ku,
Tokyo 153-0064
Japan
0120 191014 or +81 3 5437 9125
support.japan@freescale.com

Asia/Pacific:
Freescale Semiconductor Hong Kong Ltd.
Technical Information Center
2 Dai King Street
Tai Po Industrial Estate
Tai Po, N.T., Hong Kong
+800 2666 8080
support.asia@freescale.com

For Literature Requests Only:
Freescale Semiconductor Literature Distribution Center
P.O. Box 5405
Denver, Colorado 80217
1-800-441-2447 or 303-675-2140
Fax: 303-675-2150
LDCForFreescaleSemiconductor@hibbertgroup.com

Information in this document is provided solely to enable system and software implementers to use Freescale Semiconductor products. There are no express or implied copyright licenses granted hereunder to design or fabricate any integrated circuits or integrated circuits based on the information in this document.

Freescale Semiconductor reserves the right to make changes without further notice to any products herein. Freescale Semiconductor makes no warranty, representation or guarantee regarding the suitability of its products for any particular purpose, nor does Freescale Semiconductor assume any liability arising out of the application or use of any product or circuit, and specifically disclaims any and all liability, including without limitation consequential or incidental damages. "Typical" parameters that may be provided in Freescale Semiconductor data sheets and/or specifications can and do vary in different applications and actual performance may vary over time. All operating parameters, including "Typicals", must be validated for each customer application by customer's technical experts. Freescale Semiconductor does not convey any license under its patent rights nor the rights of others. Freescale Semiconductor products are not designed, intended, or authorized for use as components in systems intended for surgical implant into the body, or other applications intended to support or sustain life, or for any other application in which the failure of the Freescale Semiconductor product could create a situation where personal injury or death may occur. Should Buyer purchase or use Freescale Semiconductor products for any such unintended or unauthorized application, Buyer shall indemnify and hold Freescale Semiconductor and its officers, employees, subsidiaries, affiliates, and distributors harmless against all claims, costs, damages, and expenses, and reasonable attorney fees arising out of, directly or indirectly, any claim of personal injury or death associated with such unintended or unauthorized use, even if such claim alleges that Freescale Semiconductor was negligent regarding the design or manufacture of the part.

Freescale™ and the Freescale logo are trademarks of Freescale Semiconductor, Inc. All other product or service names are the property of their respective owners.
© Freescale Semiconductor, Inc. 2006. All rights reserved.

