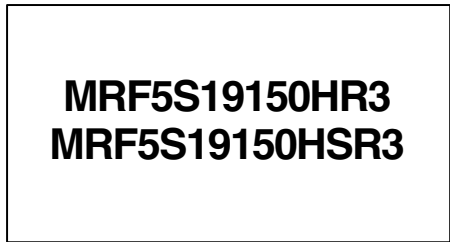


# RF Power Field Effect Transistors

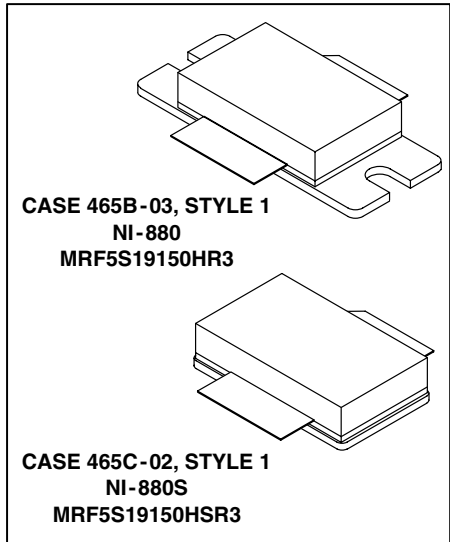
## N-Channel Enhancement-Mode Lateral MOSFETs

Designed for PCN and PCS base station applications at frequencies from 1900 to 2000 MHz. Suitable for TDMA, CDMA and multicarrier amplifier applications.

- Typical 2-Carrier N-CDMA Performance for  $V_{DD} = 28$  Volts,  $I_{DQ} = 1400$  mA, Avg.,  $P_{out} = 32$  Watts Avg., Full Frequency Band, IS-95 CDMA (Pilot, Sync, Paging, Traffic Codes 8 Through 13) Channel Bandwidth = 1.2288 MHz. Peak/Avg. = 9.8 dB @ 0.01% Probability on CCDF.  
 Power Gain — 14 dB  
 Drain Efficiency — 26%  
 IM3 @ 2.5 MHz Offset — -36.5 dBc @ 1.2288 MHz Bandwidth  
 ACPR @ 885 kHz Offset — -50 dB @ 30 kHz Bandwidth
- Capable of Handling 5:1 VSWR, @ 28 Vdc,  $f_1 = 1960$  MHz, 100 Watts CW Output Power
- Characterized with Series Equivalent Large-Signal Impedance Parameters
- Internally Matched, Controlled Q, for Ease of Use
- Qualified Up to a Maximum of 32 V Operation
- Integrated ESD Protection
- Lower Thermal Resistance Package
- Low Gold Plating Thickness on Leads, 40 $\mu$ " Nominal.
- In Tape and Reel. R3 Suffix = 250 Units per 56 mm, 13 inch Reel.



**1990 MHz, 32 W AVG., 28 V**  
**2 x N-CDMA**  
**LATERAL N-CHANNEL**  
**RF POWER MOSFETs**



**Table 1. Maximum Ratings**

Rating	Symbol	Value	Unit
Drain-Source Voltage	$V_{DSS}$	-0.5, +65	Vdc
Gate-Source Voltage	$V_{GS}$	-0.5, +15	Vdc
Total Device Dissipation @ $T_C = 25^\circ\text{C}$ Derate above 25 $^\circ\text{C}$	$P_D$	427 2.44	W W/ $^\circ\text{C}$
Storage Temperature Range	$T_{stg}$	- 65 to +150	$^\circ\text{C}$
Operating Junction Temperature	$T_J$	200	$^\circ\text{C}$
CW Operation	CW	100	W

**Table 2. Thermal Characteristics**

Characteristic	Symbol	Value (1,2)	Unit
Thermal Resistance, Junction to Case Case Temperature 80 $^\circ\text{C}$ , 100 W CW Case Temperature 75 $^\circ\text{C}$ , 32 W CW	$R_{\theta JC}$	0.41 0.44	$^\circ\text{C}/\text{W}$

1. MTTF calculator available at <http://www.freescale.com/rf>. Select Tools/Software/Application Software/Calculators to access the MTTF calculators by product.
2. Refer to AN1955/D, *Thermal Measurement Methodology of RF Power Amplifiers*. Go to <http://www.freescale.com/rf>. Select Documentation/Application Notes - AN1955.

**NOTE - CAUTION** - MOS devices are susceptible to damage from electrostatic charge. Reasonable precautions in handling and packaging MOS devices should be observed.

**Table 3. ESD Protection Characteristics**

Test Conditions	Class
Human Body Model	1 (Minimum)
Machine Model	M3 (Minimum)
Charge Device Model	C7 (Minimum)

**Table 4. Electrical Characteristics** ( $T_C = 25^\circ\text{C}$  unless otherwise noted)

Characteristic	Symbol	Min	Typ	Max	Unit
<b>Off Characteristics</b>					
Zero Gate Voltage Drain Leakage Current ( $V_{DS} = 65\text{ Vdc}$ , $V_{GS} = 0\text{ Vdc}$ )	$I_{DSS}$	—	—	10	$\mu\text{Adc}$
Zero Gate Voltage Drain Leakage Current ( $V_{DS} = 28\text{ Vdc}$ , $V_{GS} = 0\text{ Vdc}$ )	$I_{DSS}$	—	—	1	$\mu\text{Adc}$
Gate-Source Leakage Current ( $V_{GS} = 5\text{ Vdc}$ , $V_{DS} = 0\text{ Vdc}$ )	$I_{GSS}$	—	—	1	$\mu\text{Adc}$
<b>On Characteristics</b>					
Gate Threshold Voltage ( $V_{DS} = 10\text{ Vdc}$ , $I_D = 360\ \mu\text{Adc}$ )	$V_{GS(th)}$	2.5	2.8	3.5	Vdc
Gate Quiescent Voltage ( $V_{DS} = 28\text{ Vdc}$ , $I_D = 1400\ \text{mA}$ )	$V_{GS(Q)}$	—	3.8	—	Vdc
Drain-Source On-Voltage ( $V_{GS} = 10\text{ Vdc}$ , $I_D = 3.6\ \text{Adc}$ )	$V_{DS(on)}$	—	0.24	—	Vdc
Forward Transconductance ( $V_{DS} = 10\text{ Vdc}$ , $I_D = 3.6\ \text{Adc}$ )	$g_{fs}$	—	9	—	S
<b>Dynamic Characteristics</b>					
Reverse Transfer Capacitance (1) ( $V_{DS} = 28\text{ Vdc}$ , $V_{GS} = 0$ , $f = 1\ \text{MHz}$ )	$C_{rss}$	—	3.1	—	pF

**Functional Tests** (In Freescale Test Fixture, 50 ohm system)  $V_{DD} = 28\text{ Vdc}$ ,  $I_{DQ} = 1400\ \text{mA}$ ,  $P_{out} = 32\ \text{W Avg.}$ ,  $f_1 = 1930\ \text{MHz}$ ,  $f_2 = 1932.5\ \text{MHz}$  and  $f_1 = 1987.5\ \text{MHz}$ ,  $f_2 = 1990\ \text{MHz}$ , 2-Carrier N-CDMA, 1.2288 MHz Channel Bandwidth Carriers. ACPR measured in 30 kHz Channel Bandwidth @  $\pm 885\ \text{kHz}$  Offset. IM3 measured in 1.2288 MHz Channel Bandwidth @  $\pm 2.5\ \text{MHz}$  Offset. Peak/Avg = 9.8 dB @ 0.01% Probability on CCDF.

Power Gain	$G_{ps}$	13	14	—	dB
Drain Efficiency	$\eta_D$	24	26	—	%
Intermodulation Distortion	IM3	—	-36.5	-35	dBc
Adjacent Channel Power Ratio	ACPR	—	-50	-48	dBc
Input Return Loss	IRL	—	-17	-9	dB

1. Part is internally matched both on input and output.

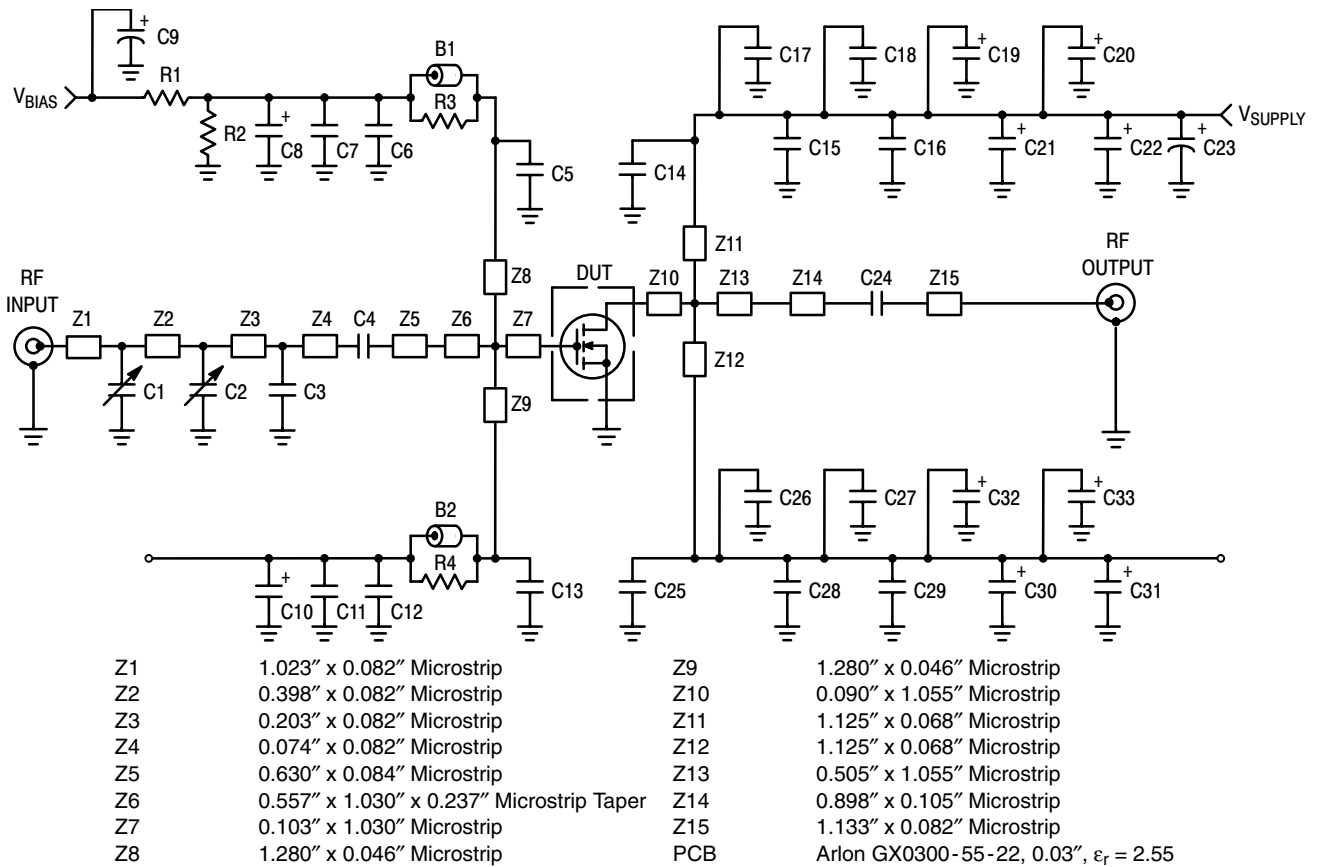
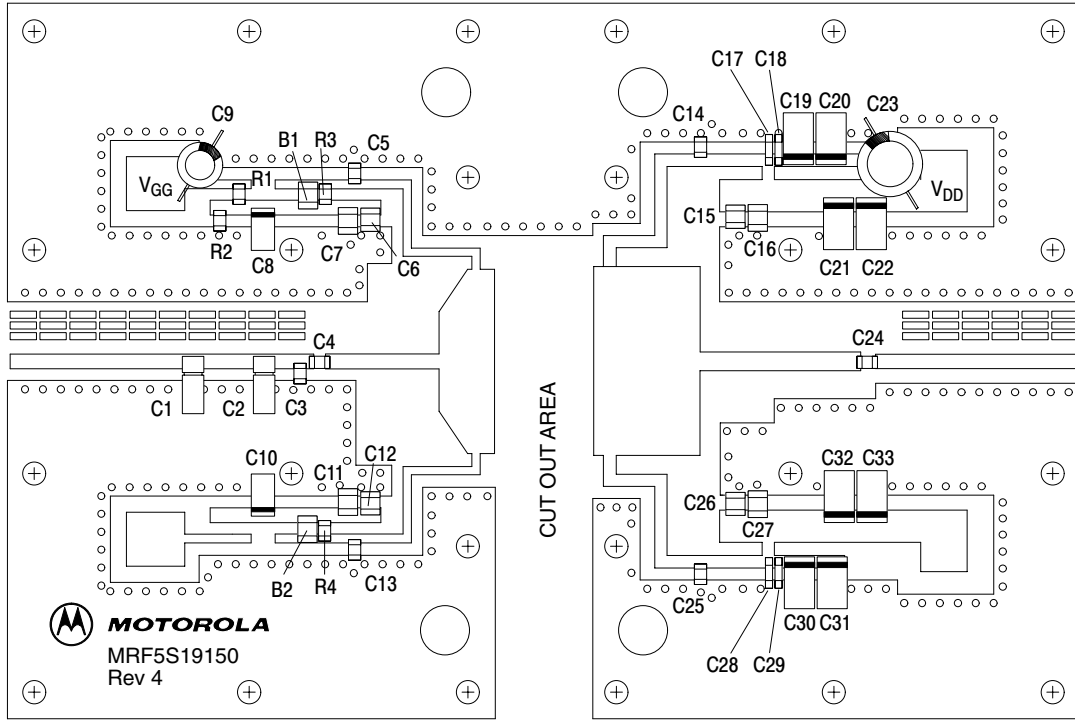


Figure 1. MRF5S19150HR3(SR3) Test Circuit Schematic

Table 5. MRF5S19150HR3(SR3) Test Circuit Component Designations and Values

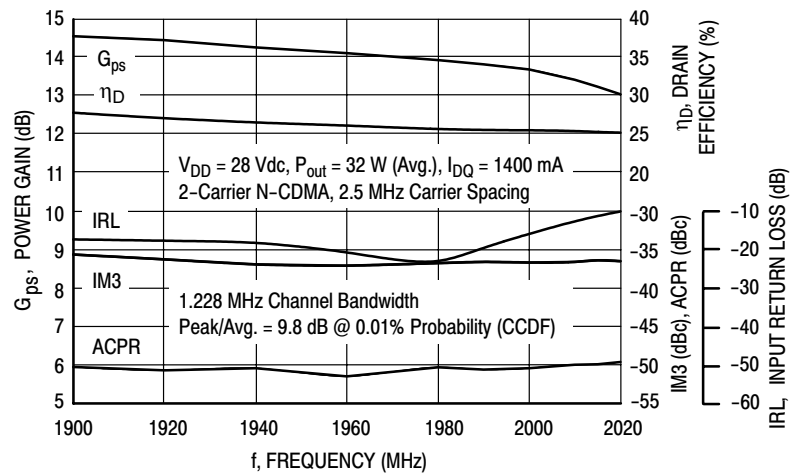
Part	Description
B1, B2	Short RF Beads
C1, C2	0.6 – 4.5 Variable Capacitors, Gigatrim
C3	0.8 pF Chip Capacitor
C4, C5, C13, C14, C24, C25	9.1 pF Chip Capacitors
C8, C10	1.0 $\mu$ F, 50 V SMT Tantalum Capacitors
C6, C12, C16, C17, C18, C27, C28, C29	0.1 $\mu$ F Chip Capacitors
C7, C11, C15, C26	1000 pF Chip Capacitors
C9	100 $\mu$ F, 50 V Electrolytic Capacitor
C23	470 $\mu$ F, 63 V Electrolytic Capacitor
C19, C20, C21, C22, C30, C31, C32, C33	22 $\mu$ F, 35 V Tantalum Capacitors
R1	1 k $\Omega$ Chip Resistor
R2	560 k $\Omega$ Chip Resistor
R3, R4	12 $\Omega$ Chip Resistors



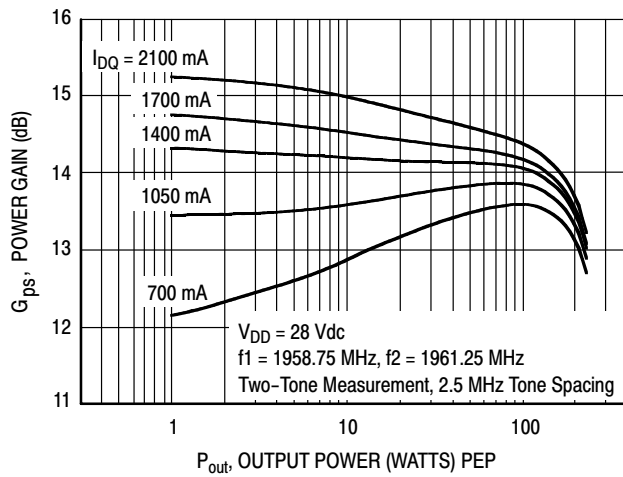
Freescale has begun the transition of marking Printed Circuit Boards (PCBs) with the Freescale Semiconductor signature/logo. PCBs may have either Motorola or Freescale markings during the transition period. These changes will have no impact on form, fit or function of the current product.

**Figure 2. MRF5S19150HR3(SR3) Test Circuit Component Layout**

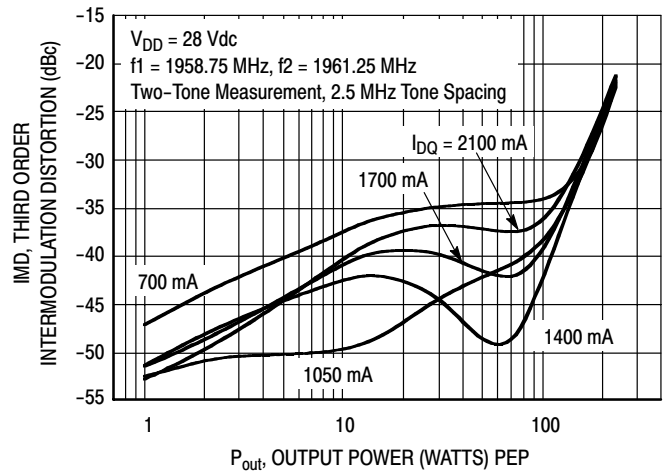
## TYPICAL CHARACTERISTICS



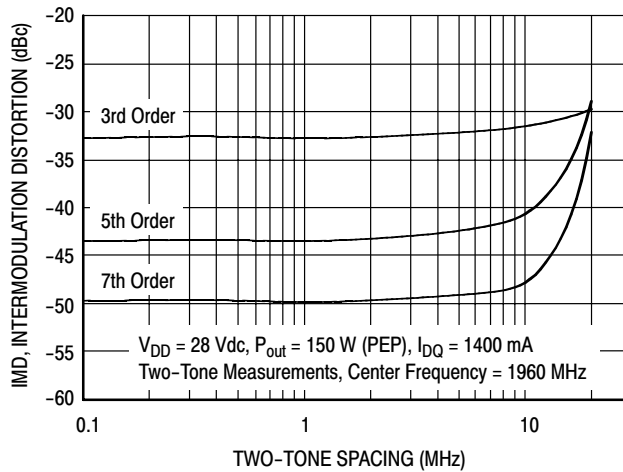
**Figure 3. 2-Carrier N-CDMA Broadband Performance**



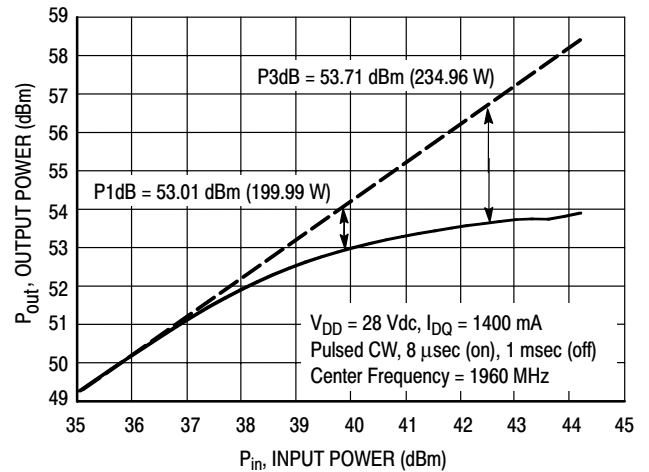
**Figure 4. Two-Tone Power Gain versus Output Power**



**Figure 5. Third Order Intermodulation versus Output Power**



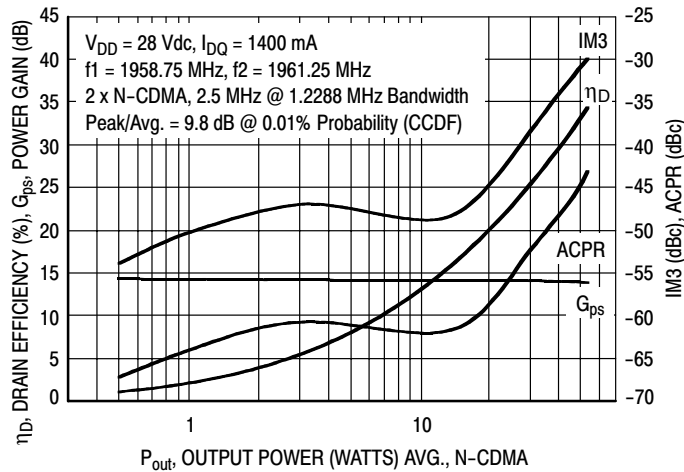
**Figure 6. Intermodulation Distortion Products versus Tone Spacing**



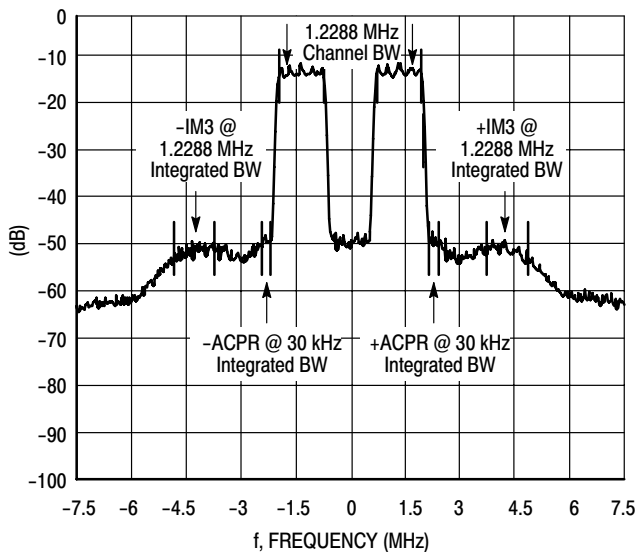
**Figure 7. Pulse CW Output Power versus Input Power**

MRF5S19150HR3 MRF5S19150HSR3

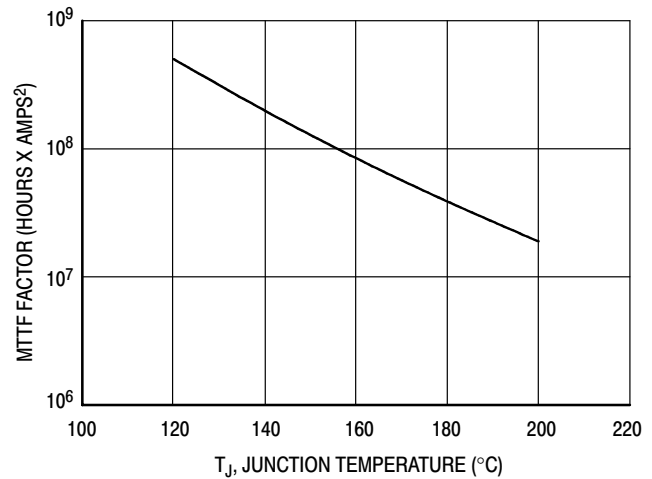
## TYPICAL CHARACTERISTICS



**Figure 8. 2-Carrier N-CDMA ACPR, IM3, Power Gain, Drain Efficiency versus Output Power**

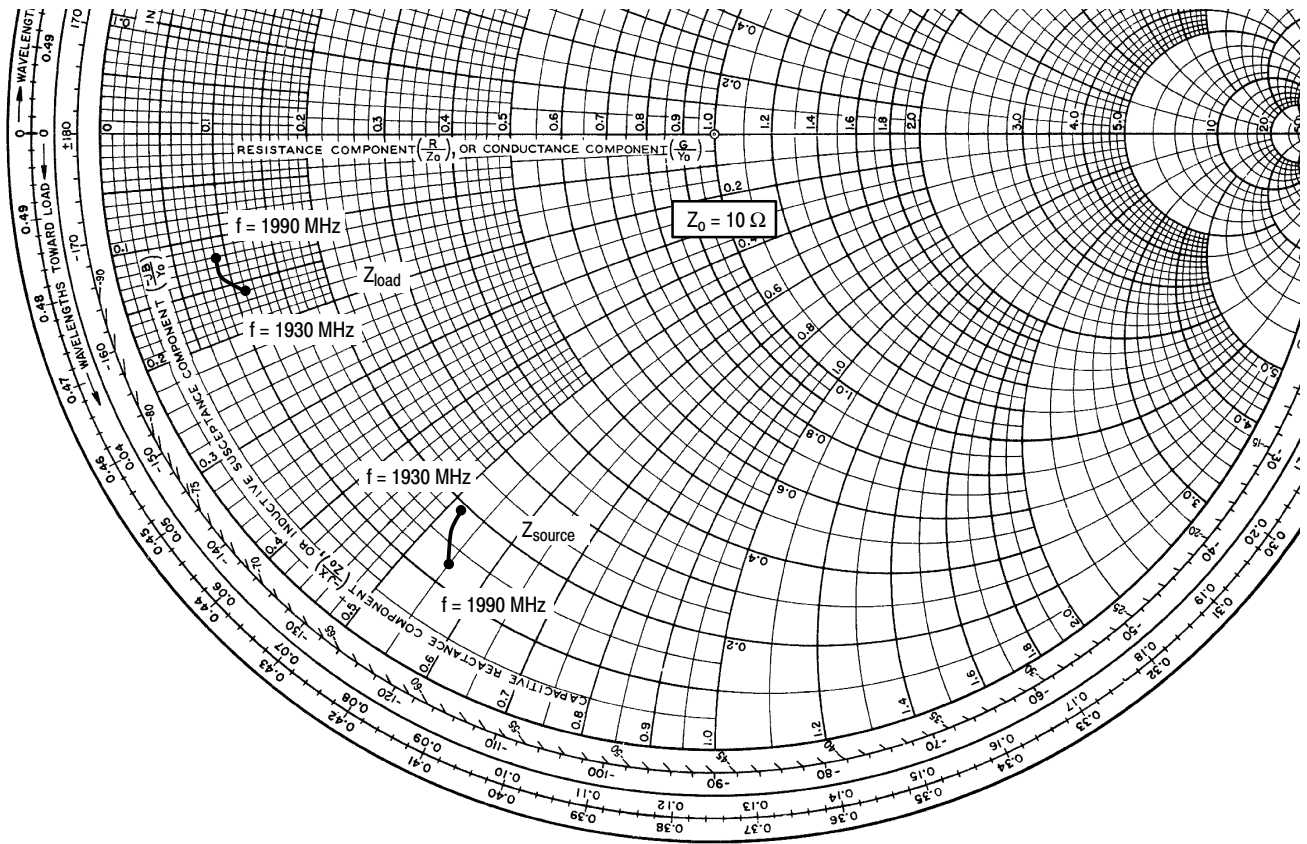


**Figure 9. 2-Carrier N-CDMA Spectrum**



This above graph displays calculated MTTF in hours x ampere<sup>2</sup> drain current. Life tests at elevated temperatures have correlated to better than  $\pm 10\%$  of the theoretical prediction for metal failure. Divide MTTF factor by  $I_D^2$  for MTTF in a particular application.

**Figure 10. MTTF Factor versus Junction Temperature**



$V_{DD} = 28\text{ V}$ ,  $I_{DQ} = 1400\text{ mA}$ ,  $P_{out} = 32\text{ W Avg.}$

f MHz	$Z_{source}$ $\Omega$	$Z_{load}$ $\Omega$
1930	$1.89 - j5.24$	$1.06 - j1.58$
1960	$1.64 - j5.29$	$0.88 - j1.37$
1990	$1.3 - j5.49$	$0.90 - j1.21$

$Z_{source}$  = Test circuit impedance as measured from gate to ground.

$Z_{load}$  = Test circuit impedance as measured from drain to ground.

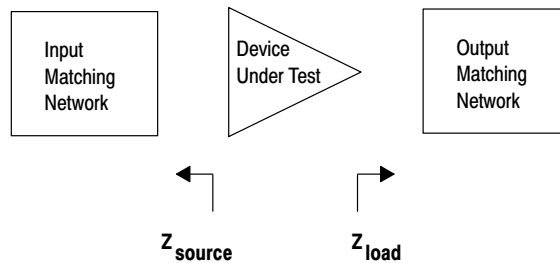


Figure 11. Series Equivalent Source and Load Impedance

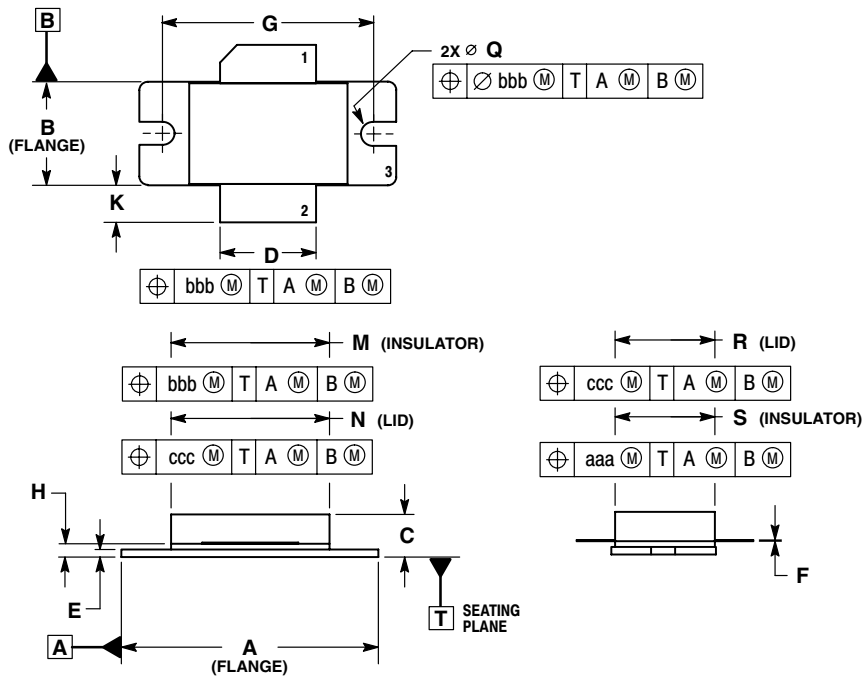
# NOTES



# NOTES

# NOTES

## PACKAGE DIMENSIONS

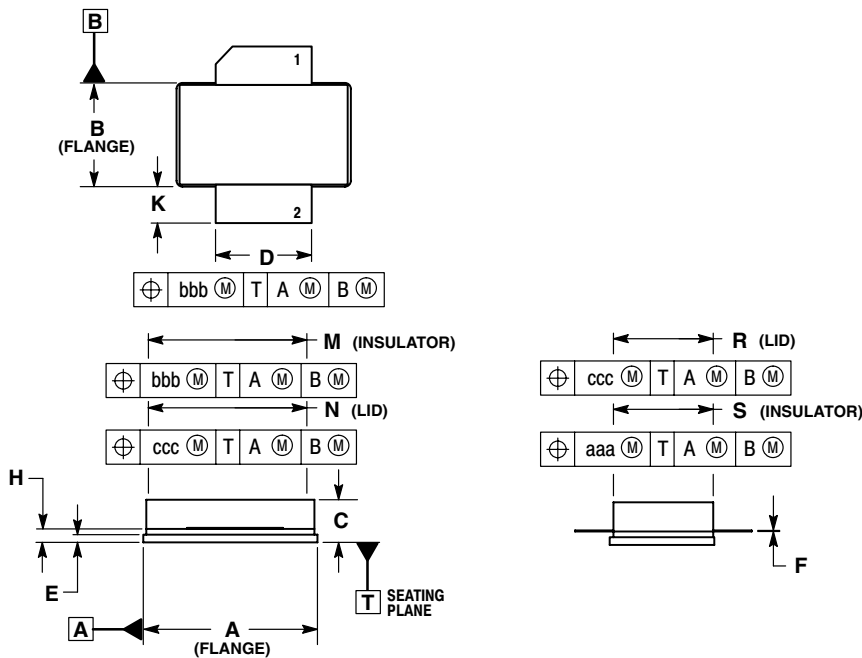


**CASE 465B-03  
ISSUE B  
NI-880  
MRF5S19150HR3**

- NOTES:
1. DIMENSIONING AND TOLERANCING PER ANSI Y14.5M-1994.
  2. CONTROLLING DIMENSION: INCH.
  3. DIMENSION H IS MEASURED 0.030 (0.762) AWAY FROM PACKAGE BODY.
  4. DELETED

DIM	INCHES		MILLIMETERS	
	MIN	MAX	MIN	MAX
A	1.335	1.345	33.91	34.16
B	0.535	0.545	13.6	13.8
C	0.147	0.200	3.73	5.08
D	0.495	0.505	12.57	12.83
E	0.035	0.045	0.89	1.14
F	0.003	0.006	0.08	0.15
G	1.100 BSC		27.94 BSC	
H	0.057	0.067	1.45	1.70
K	0.170	0.210	4.32	5.33
M	0.872	0.888	22.15	22.55
N	0.871	0.889	19.30	22.60
Q	$\varnothing$ 0.118	$\varnothing$ 0.138	$\varnothing$ 3.00	$\varnothing$ 3.51
R	0.515	0.525	13.10	13.30
S	0.515	0.525	13.10	13.30
aaa	0.007 REF		0.178 REF	
bbb	0.010 REF		0.254 REF	
ccc	0.015 REF		0.381 REF	

- STYLE 1:  
PIN 1. DRAIN  
2. GATE  
3. SOURCE



**CASE 465C-02  
ISSUE A  
NI-880S  
MRF5S19150HSR3**

- NOTES:
1. DIMENSIONING AND TOLERANCING PER ANSI Y14.5M-1994.
  2. CONTROLLING DIMENSION: INCH.
  3. DIMENSION H IS MEASURED 0.030 (0.762) AWAY FROM PACKAGE BODY.

DIM	INCHES		MILLIMETERS	
	MIN	MAX	MIN	MAX
A	0.905	0.915	22.99	23.24
B	0.535	0.545	13.60	13.80
C	0.147	0.200	3.73	5.08
D	0.495	0.505	12.57	12.83
E	0.035	0.045	0.89	1.14
F	0.003	0.006	0.08	0.15
H	0.057	0.067	1.45	1.70
K	0.170	0.210	4.32	5.33
M	0.872	0.888	22.15	22.55
N	0.871	0.889	19.30	22.60
R	0.515	0.525	13.10	13.30
S	0.515	0.525	13.10	13.30
aaa	0.007 REF		0.178 REF	
bbb	0.010 REF		0.254 REF	
ccc	0.015 REF		0.381 REF	

- STYLE 1:  
PIN 1. DRAIN  
2. GATE  
3. SOURCE

MRF5S19150HR3 MRF5S19150HSR3

## **How to Reach Us:**

**Home Page:**  
www.freescale.com

**E-mail:**  
support@freescale.com

**USA/Europe or Locations Not Listed:**  
Freescale Semiconductor  
Technical Information Center, CH370  
1300 N. Alma School Road  
Chandler, Arizona 85224  
+1-800-521-6274 or +1-480-768-2130  
support@freescale.com

**Europe, Middle East, and Africa:**  
Freescale Halbleiter Deutschland GmbH  
Technical Information Center  
Schatzbogen 7  
81829 Muenchen, Germany  
+44 1296 380 456 (English)  
+46 8 52200080 (English)  
+49 89 92103 559 (German)  
+33 1 69 35 48 48 (French)  
support@freescale.com

**Japan:**  
Freescale Semiconductor Japan Ltd.  
Headquarters  
ARCO Tower 15F  
1-8-1, Shimo-Meguro, Meguro-ku,  
Tokyo 153-0064  
Japan  
0120 191014 or +81 3 5437 9125  
support.japan@freescale.com

**Asia/Pacific:**  
Freescale Semiconductor Hong Kong Ltd.  
Technical Information Center  
2 Dai King Street  
Tai Po Industrial Estate  
Tai Po, N.T., Hong Kong  
+800 2666 8080  
support.asia@freescale.com

**For Literature Requests Only:**  
Freescale Semiconductor Literature Distribution Center  
P.O. Box 5405  
Denver, Colorado 80217  
1-800-441-2447 or 303-675-2140  
Fax: 303-675-2150  
LDCForFreescaleSemiconductor@hibbertgroup.com

Information in this document is provided solely to enable system and software implementers to use Freescale Semiconductor products. There are no express or implied copyright licenses granted hereunder to design or fabricate any integrated circuits or integrated circuits based on the information in this document.

Freescale Semiconductor reserves the right to make changes without further notice to any products herein. Freescale Semiconductor makes no warranty, representation or guarantee regarding the suitability of its products for any particular purpose, nor does Freescale Semiconductor assume any liability arising out of the application or use of any product or circuit, and specifically disclaims any and all liability, including without limitation consequential or incidental damages. "Typical" parameters that may be provided in Freescale Semiconductor data sheets and/or specifications can and do vary in different applications and actual performance may vary over time. All operating parameters, including "Typicals", must be validated for each customer application by customer's technical experts. Freescale Semiconductor does not convey any license under its patent rights nor the rights of others. Freescale Semiconductor products are not designed, intended, or authorized for use as components in systems intended for surgical implant into the body, or other applications intended to support or sustain life, or for any other application in which the failure of the Freescale Semiconductor product could create a situation where personal injury or death may occur. Should Buyer purchase or use Freescale Semiconductor products for any such unintended or unauthorized application, Buyer shall indemnify and hold Freescale Semiconductor and its officers, employees, subsidiaries, affiliates, and distributors harmless against all claims, costs, damages, and expenses, and reasonable attorney fees arising out of, directly or indirectly, any claim of personal injury or death associated with such unintended or unauthorized use, even if such claim alleges that Freescale Semiconductor was negligent regarding the design or manufacture of the part.

Freescale™ and the Freescale logo are trademarks of Freescale Semiconductor, Inc. All other product or service names are the property of their respective owners.  
© Freescale Semiconductor, Inc. 2004. All rights reserved.

