

The RF MOSFET Line

RF Power Field Effect Transistors

N-Channel Enhancement-Mode Lateral MOSFETs

Designed for broadband commercial and industrial applications with frequencies from 470 to 860 MHz. The high gain and broadband performance of these devices make them ideal for large-signal, common source amplifier applications in 28/32 volt transmitter equipment.

- Typical CW Performance at 860 MHz, 32 Volts, Narrowband Fixture
 - Output Power — 75 Watts
 - Power Gain — 18.2 dB
 - Efficiency — 60%
- 100% Tested for Load Mismatch Stress at All Phase Angles with 10:1 VSWR @ 32 Vdc, 860 MHz, 75 Watts CW
- Integrated ESD Protection
- Excellent Thermal Stability
- Characterized with Series Equivalent Large-Signal Impedance Parameters
- In Tape and Reel. R1 = 500 units per 32 mm, 13 inch Reel.
- Low Gold Plating Thickness on Leads.
L Suffix Indicates 40μ" Nominal.

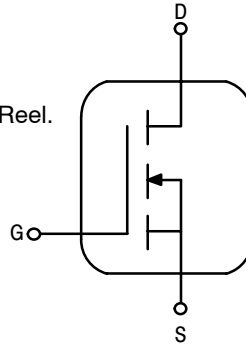

MRF373ALR1

MRF373ALSR1

470 - 860 MHz, 75 W, 32 V
LATERAL N-CHANNEL
BROADBAND
RF POWER MOSFETs

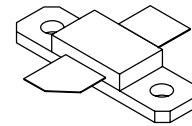

CASE 360B-05, STYLE 1
NI-360
MRF373ALR1

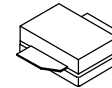

CASE 360C-05, STYLE 1
NI-360S
MRF373ALSR1

MAXIMUM RATINGS

Rating	Symbol	Value	Unit
Drain-Source Voltage	V_{DSS}	70	Vdc
Gate-Source Voltage	V_{GS}	- 0.5, +15	Vdc
Total Device Dissipation @ $T_C = 25^\circ\text{C}$ Derate above 25°C	MRF373ALR1 P_D	197 1.12	Watts W/ $^\circ\text{C}$
	MRF373ALSR1	278 1.59	Watts W/ $^\circ\text{C}$
Storage Temperature Range	T_{stg}	- 65 to +150	$^\circ\text{C}$
Operating Junction Temperature	T_J	200	$^\circ\text{C}$

THERMAL CHARACTERISTICS

Characteristic	Symbol	Max	Unit
Thermal Resistance, Junction to Case	$R_{\theta JC}$	0.89 0.63	$^\circ\text{C}/\text{W}$
	MRF373ALR1		
	MRF373ALSR1		

ESD PROTECTION CHARACTERISTICS

Test Conditions	Class
Human Body Model	1 (Minimum)
Machine Model	M2 (Minimum) M1 (Minimum)
	MRF373ALR1
	MRF373ALSR1

NOTE - **CAUTION** - MOS devices are susceptible to damage from electrostatic charge. Reasonable precautions in handling and packaging MOS devices should be observed.

Freescale Semiconductor, Inc.

ELECTRICAL CHARACTERISTICS (T_C = 25°C unless otherwise noted)

Characteristic	Symbol	Min	Typ	Max	Unit
----------------	--------	-----	-----	-----	------

OFF CHARACTERISTICS

Drain-Source Breakdown Voltage (V _{GS} = 0 Vdc, I _D = 1 μA)	V _{(BR)DSS}	70	—	—	Vdc
Zero Gate Voltage Drain Current (V _{DS} = 32 Vdc, V _{GS} = 0 Vdc)	I _{DSS}	—	—	1	μAdc
Gate-Source Leakage Current (V _{GS} = 5 Vdc, V _{DS} = 0 Vdc)	I _{GSS}	—	—	1	μAdc

ON CHARACTERISTICS

Gate Threshold Voltage (V _{DS} = 10 V, I _D = 200 μA)	V _{GS(th)}	2	2.9	4	Vdc
Gate Quiescent Voltage (V _{DS} = 32 V, I _D = 100 mA)	V _{GS(Q)}	2.5	3.3	4.5	Vdc
Drain-Source On-Voltage (V _{GS} = 10 V, I _D = 3 A)	V _{DS(on)}	—	0.41	0.45	Vdc

DYNAMIC CHARACTERISTICS

Input Capacitance (V _{DS} = 32 V, V _{GS} = 0, f = 1 MHz)	C _{iss}	—	98.5	—	pF
Output Capacitance (V _{DS} = 32 V, V _{GS} = 0, f = 1 MHz)	C _{oss}	—	49	—	pF
Reverse Transfer Capacitance (V _{DS} = 32 V, V _{GS} = 0, f = 1 MHz)	C _{rss}	—	2	—	pF

FUNCTIONAL CHARACTERISTICS (50 ohm system)

Common Source Power Gain (V _{DD} = 32 V, P _{out} = 75 W CW, I _{DQ} = 200 mA, f = 860 MHz)	G _{ps}	16.5	18.2	—	dB
Drain Efficiency (V _{DD} = 32 V, P _{out} = 75 W CW, I _{DQ} = 200 mA, f = 860 MHz)	η	56	60	—	%
Load Mismatch (V _{DD} = 32 V, P _{out} = 75 W CW, I _{DQ} = 200 mA, f = 860 MHz, Load VSWR at 10:1 at All Phase Angles)	ψ	No Degradation in Output Power			

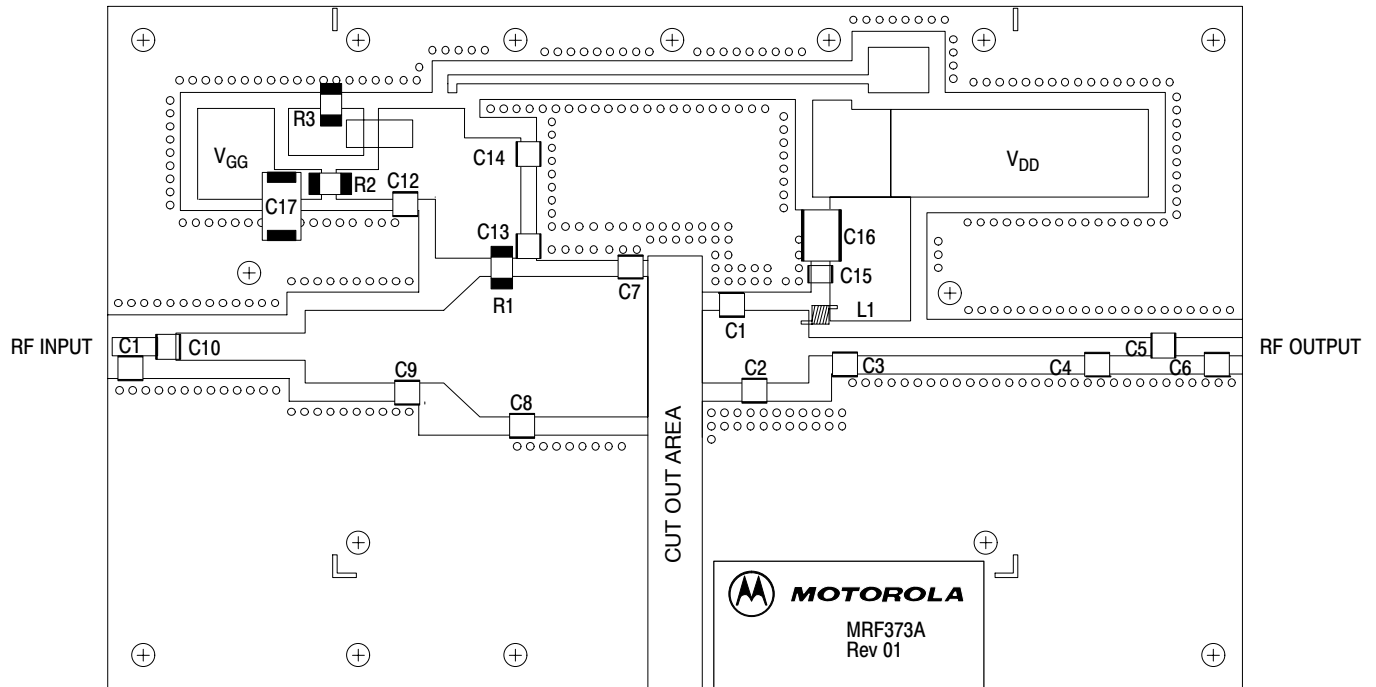

Figure 1. MRF373ALR1/ALS1 Narrowband Test Circuit Component Layout

Table 1. MRF373ALR1/ALS1 Narrowband Test Circuit Component Layout Designations and Values

Designation	Description
C1, C2	18 pF Chip Capacitors, B Case, ATC
C3	12 pF Chip Capacitor, B Case, ATC
C4	1.8 pF Chip Capacitor, B Case, ATC
C5, C10	51 pF Chip Capacitors, B Case, ATC
C6	0.3 pF Chip Capacitor, B Case, ATC (Used only on the MRF373AS)
C7	15 pF Chip Capacitor, B Case, ATC
C8	10 pF Chip Capacitor, B Case, ATC
C9	2.7 pF Chip Capacitor, B Case, ATC
C11	0.5 pF Chip Capacitor, B Case, ATC
C12	1000 pF Chip Capacitor, B Case, ATC
C13	39 pF Chip Capacitor, B Case, ATC
C14, C15	470 pF Chip Capacitors, B Case, ATC
C16	2.2 μ F, 100 V Chip Capacitor, Vishay #VJ3640Y225KXBAT
C17	10 μ F, 35 V Tantalum Capacitor, Kemet #T491D106K35AS
L1A	12 nH, Coilcraft #A04T
R1, R2	390 Ω , 1/2 Ω Chip Resistors, Vishay Dale (2010)
R3	1 k Ω , 1/2 Ω Chip Resistor, Vishay Dale (2010)
PCB	Arlon GX-0300-55, 30 mils, $\epsilon_r = 2.55$

Freescale Semiconductor, Inc.

TYPICAL CHARACTERISTICS

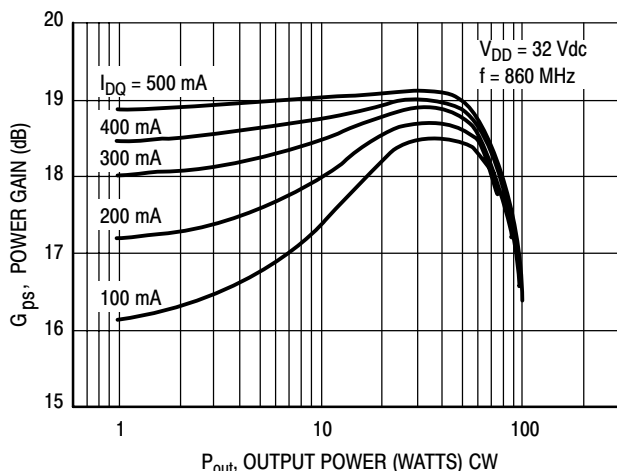

Figure 2. Power Gain versus Output Power

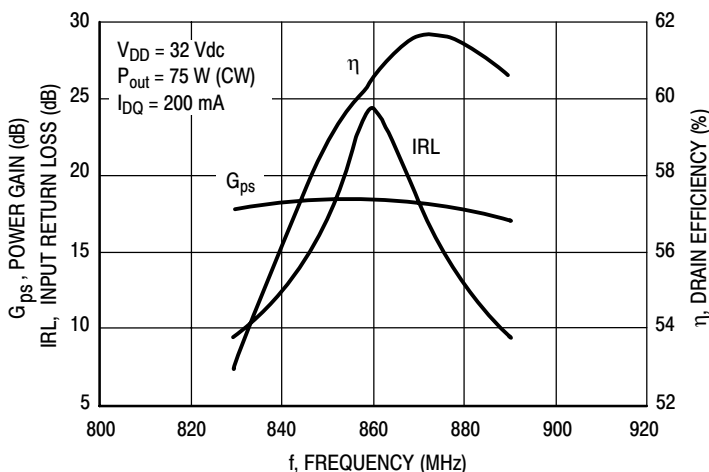

Figure 3. Performance in Narrowband Circuit

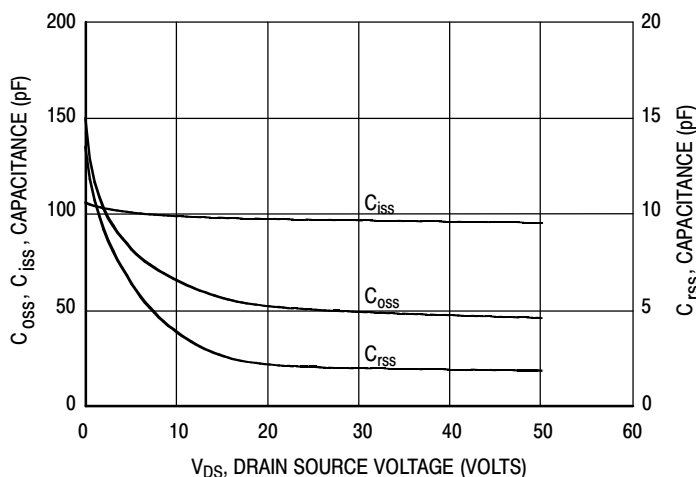
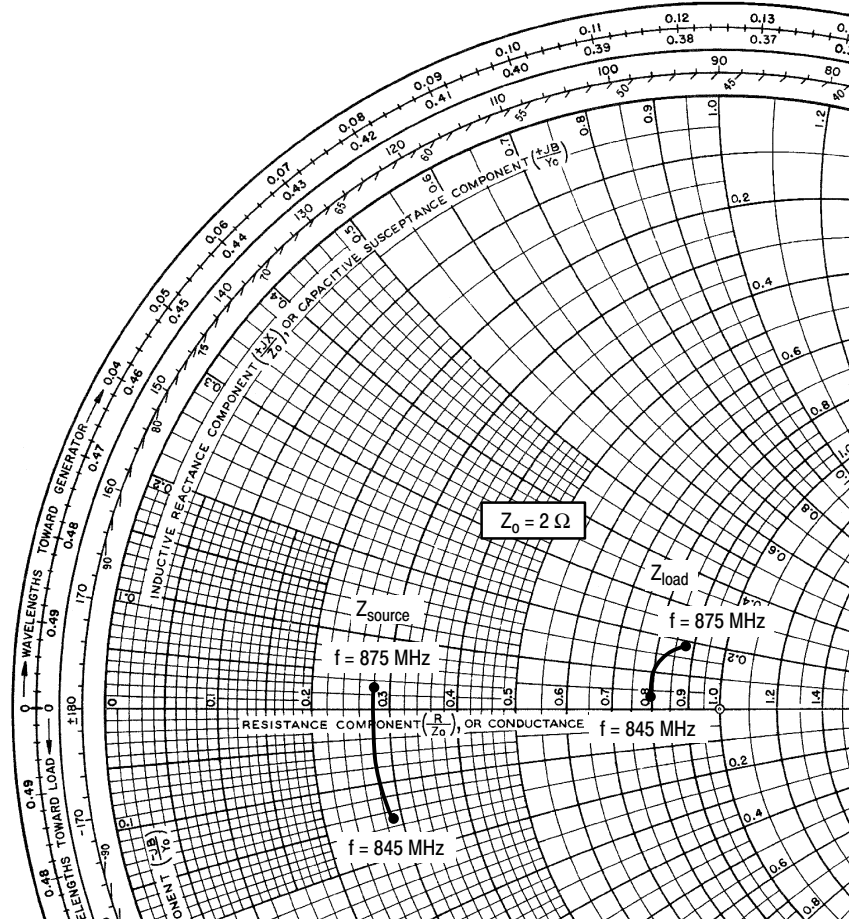

Figure 4. Capacitance versus Voltage



$V_{DD} = 32\text{ V}$, $I_{DQ} = 200\text{ mA}$, $P_{out} = 75\text{ W CW}$

f MHz	Z_{source} Ω	Z_{load} Ω
845	$0.58 - j0.29$	$1.60 + j0.07$
860	$0.56 - j0.11$	$1.65 + j0.22$
875	$0.56 + j0.06$	$1.79 + j0.38$

Z_{source} = Test circuit impedance as measured from gate to ground.

Z_{load} = Test circuit impedance as measured from drain to ground.

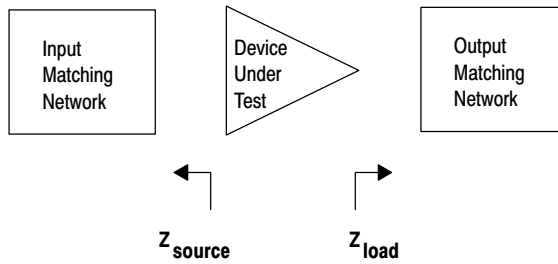
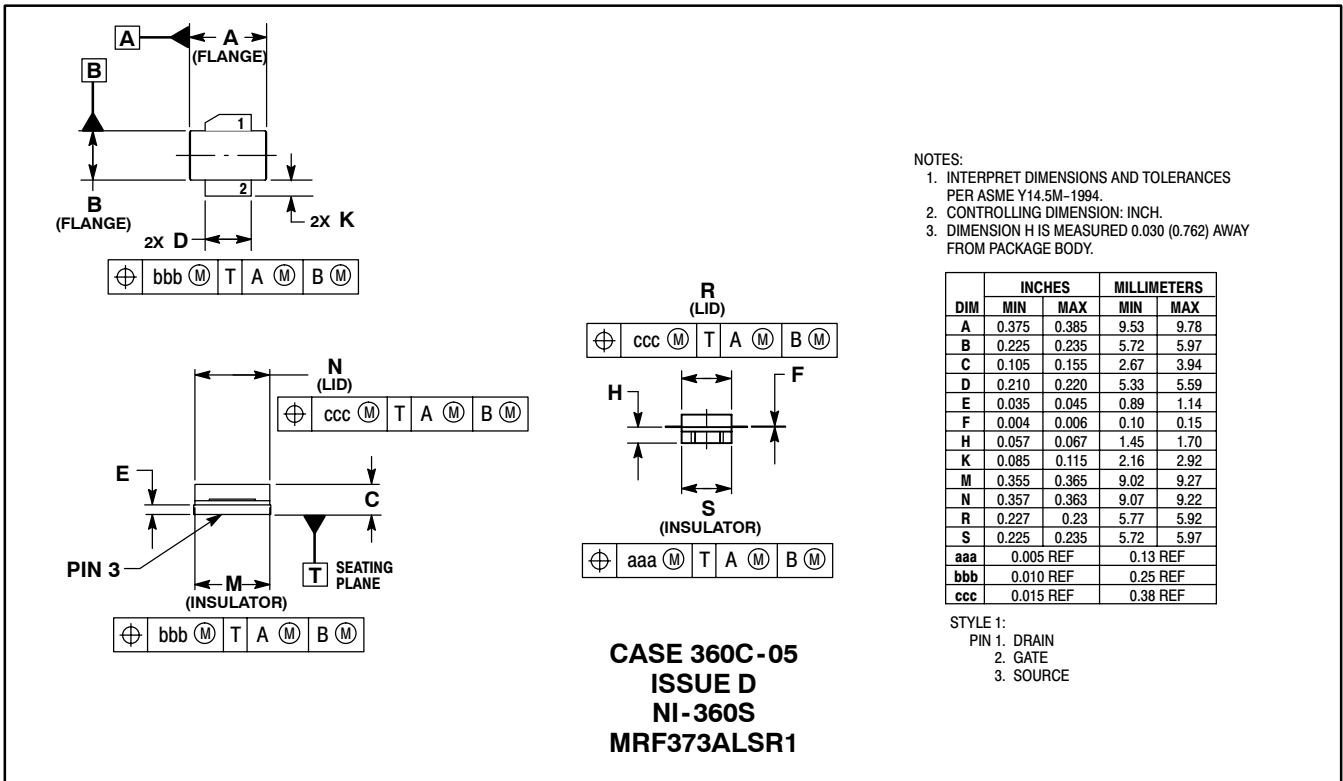
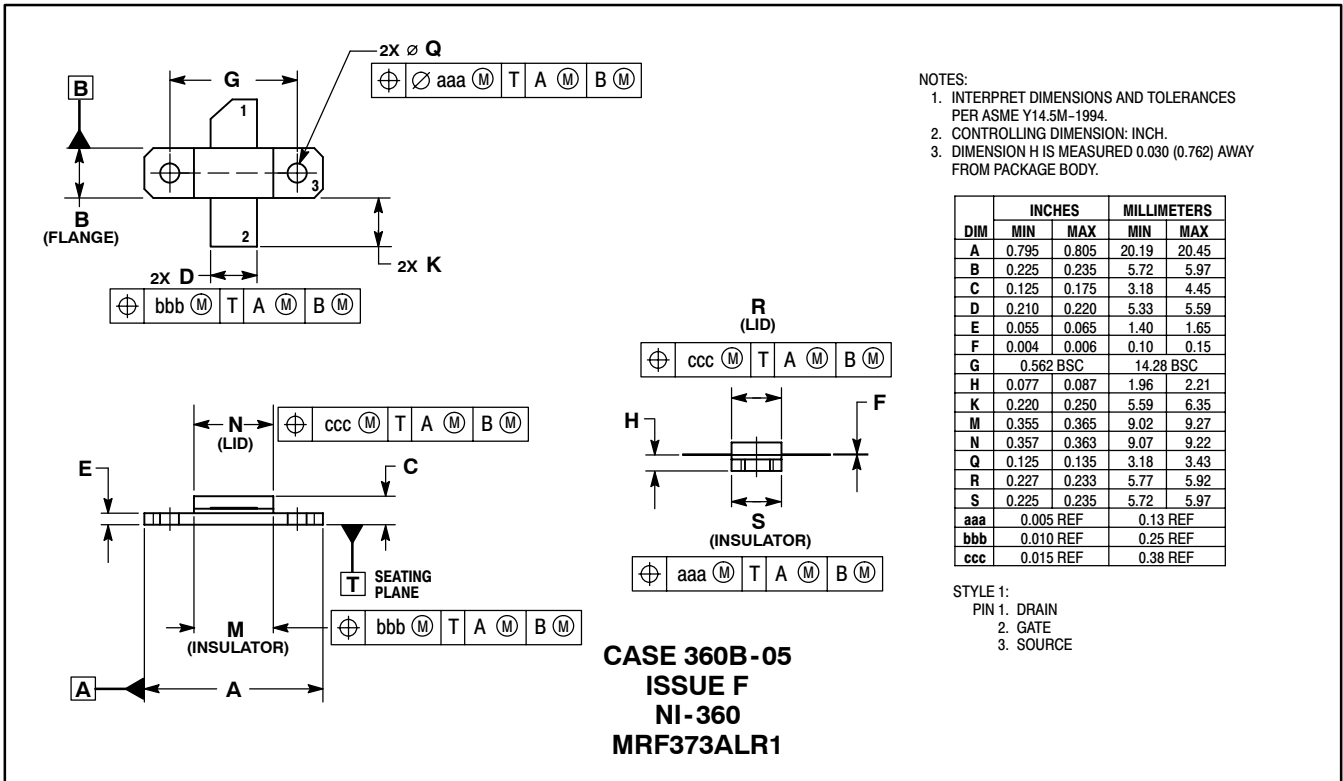

Figure 5. Series Equivalent Input and Output Impedance

NOTES

Freescale Semiconductor, Inc.

PACKAGE DIMENSIONS



Information in this document is provided solely to enable system and software implementers to use Motorola products. There are no express or implied copyright licenses granted hereunder to design or fabricate any integrated circuits or integrated circuits based on the information in this document.

Motorola reserves the right to make changes without further notice to any products herein. Motorola makes no warranty, representation or guarantee regarding the suitability of its products for any particular purpose, nor does Motorola assume any liability arising out of the application or use of any product or circuit, and specifically disclaims any and all liability, including without limitation consequential or incidental damages. "Typical" parameters that may be provided in Motorola data sheets and/or specifications can and do vary in different applications and actual performance may vary over time. All operating parameters, including "Typicals", must be validated for each customer application by customer's technical experts. Motorola does not convey any license under its patent rights nor the rights of others. Motorola products are not designed, intended, or authorized for use as components in systems intended for surgical implant into the body, or other applications intended to support or sustain life, or for any other application in which the failure of the Motorola product could create a situation where personal injury or death may occur. Should Buyer purchase or use Motorola products for any such unintended or unauthorized application, Buyer shall indemnify and hold Motorola and its officers, employees, subsidiaries, affiliates, and distributors harmless against all claims, costs, damages, and expenses, and reasonable attorney fees arising out of, directly or indirectly, any claim of personal injury or death associated with such unintended or unauthorized use, even if such claim alleges that Motorola was negligent regarding the design or manufacture of the part.

MOTOROLA and the Stylized M Logo are registered in the US Patent and Trademark Office. All other product or service names are the property of their respective owners. Motorola, Inc. is an Equal Opportunity/Affirmative Action Employer.

© Motorola Inc. 2003

HOW TO REACH US:

USA/EUROPE/LOCATIONS NOT LISTED:
Motorola Literature Distribution
P.O. Box 5405, Denver, Colorado 80217
1-800-521-6274 or 480-768-2130

JAPAN: Motorola Japan Ltd.; SPS, Technical Information Center,
3-20-1, Minami-Azabu, Minato-ku, Tokyo 106-8573, Japan
81-3-3440-3569

ASIA/PACIFIC: Motorola Semiconductors H.K. Ltd.; Silicon Harbour Centre,
2 Dai King Street, Tai Po Industrial Estate, Tai Po, N.T., Hong Kong
852-26668334

HOME PAGE: <http://motorola.com/semiconductors>



◇ **For More Information On This Product,
Go to: www.freescale.com**

MRF373A/D