



Advanced Li+ Battery-Pack Protectors

MAX1894/MAX1924

General Description

The MAX1894/MAX1924 are lithium-ion/lithium-polymer (Li+) battery-pack protector ICs for 3- or 4-series Li+ battery packs. The MAX1894/MAX1924 enhance the useful operating life of Li+ batteries by monitoring individual cell voltages and preventing over/undervoltage conditions. The MAX1894/MAX1924 also protect the battery pack against charge current, discharge current, and pack-short fault conditions.

In case of a fault condition, on-board drivers control external P-channel MOSFETs, which disconnect the cells from the pack external terminals. The external protection MOSFETs are connected in a common-source configuration that does not require external pullup resistors. The MAX1894/MAX1924 use only one current-sense resistor to achieve the protection features. All protection thresholds and delays do not require any external components and are trimmed at the factory.

If any cell voltage drops below the undervoltage threshold, the MAX1894/MAX1924 disconnect the pack from the load and power down to prevent deep discharge of the pack. The MAX1894/MAX1924 offer a trickle-charge feature, which provides a low-current path to safely charge a deeply discharged pack. The MAX1894/MAX1924 also have two logic-level inputs, which can be used by a microcontroller to disable the protection MOSFETs and to put the device in shutdown. The MAX1894/MAX1924 have low quiescent current (30µA typ) and ultra-low shutdown current (0.8µA typ) to prevent deep-cell discharge.

The MAX1894X is designed for 4-series battery packs, without hysteresis on the protection thresholds. The MAX1924V and MAX1924X include hysteresis for the 3- and 4-series packs, respectively.

Applications

3- or 4-Series Li+ Battery Packs

Features

- ◆ **Protect Against Cell Overvoltage**
Factory Programmable Limits from 4V to 4.4V
Accurate to ±0.5%
- ◆ **Protect Against Cell Undervoltage**
Factory Programmable Limits from 2V to 3.2V
Accurate to ±2.0%
- ◆ **Protect Against Charge, Discharge, and Pack-Short Current Faults**
- ◆ **Automatically Trickle Charges Deeply Discharged Cells**
- ◆ **Fully Integrated MOSFET Drivers Do Not Require Pullup Resistors**
- ◆ **0.8µA (typ) Shutdown Supply Current Prevents Deep Discharge of Cells**
- ◆ **30µA (typ) Operating Supply Current**
- ◆ **28V (max) Input Voltage**
- ◆ **Available in Small 16-Pin QSOP Package**

Pin Configuration

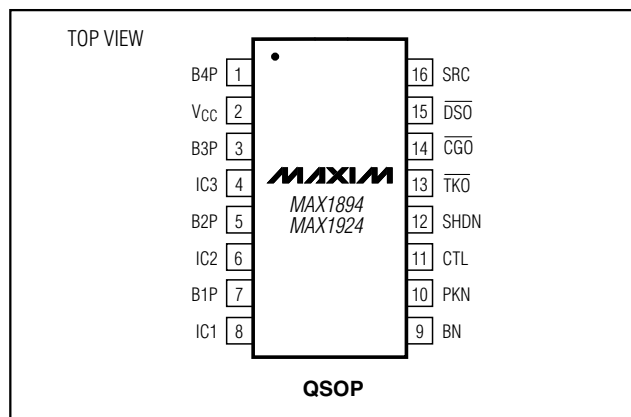

Ordering Information

PART	TEMP RANGE	PIN-PACKAGE	CELLS	OVERVOLTAGE	OVERVOLTAGE THRESHOLD HYSTERESIS
MAX1894XEEE	-40°C to +85°C	16 QSOP	4	4.25V*	No
MAX1924VEEE	-40°C to +85°C	16 QSOP	3	4.35V*	Yes
MAX1924XEEE	-40°C to +85°C	16 QSOP	4	4.35V*	Yes

*Contact factory for alternative threshold voltages.

Typical Applications Circuits appear at end of data sheet.



Maxim Integrated Products 1

For pricing, delivery, and ordering information, please contact Maxim/Dallas Direct! at 1-888-629-4642, or visit Maxim's website at www.maxim-ic.com.

Advanced Li+ Battery-Pack Protectors

ABSOLUTE MAXIMUM RATINGS

SRC, IC2, IC3, V _{CC} to BN.....	-0.3V to +28V	PKN to BN	-2V to +2V
IC1 to BN.....	-0.3V to +6V	ESD Protection on All Pins	±2000V
DSO, TKO, CGO to BN.....	-0.3V to (V _{SRC} + 0.3V)	Continuous Power Dissipation (T _A = +70°C)	
B4P to B3P	-0.3V to +6V	16-Pin QSOP (derate 8.3mW/°C above +70°C).....	667mW
B3P to B2P	-0.3V to +6V	Operating Temperature Range	-40°C to +85°C
B2P to B1P	-0.3V to +6V	Junction Temperature	+150°C
B1P to BN.....	-0.3V to +6V	Storage Temperature Range	-65°C to +150°C
CTL, SHDN to PKN.....	-0.3V to +6V	Lead Temperature (soldering, 10s)	+300°C

Stresses beyond those listed under "Absolute Maximum Ratings" may cause permanent damage to the device. These are stress ratings only, and functional operation of the device at these or any other conditions beyond those indicated in the operational sections of the specifications is not implied. Exposure to absolute maximum rating conditions for extended periods may affect device reliability.

ELECTRICAL CHARACTERISTICS

(V_{SRC} = V_{B4P} + 0.1V, each battery cell voltage (V_{CELL}) = 3.6V, V_{CTL} = V_{SHDN} = V_{PKN}, T_A = 0°C to +85°C, unless otherwise noted. Typical values are at T_A = +25°C.)

PARAMETER	SYMBOL	CONDITIONS	MIN	TYP	MAX	UNITS
SRC Input Current		V _{SRC} - V _{B_P} = 1V		20	40	μA
Supply Current (Note 1)	I _{SUP}	No faults		30	45	μA
Shutdown Supply Current	I _{SHDN}	Undervoltage without charge source		0.8	2	μA
Top Cell Sampling Current (Note 2)		V _{CELL} = 3.6V		60		μA
Intermediate Cell Input Bias Current (Note 3)		V _{CELL} = 3.6V		500		pA
V _{CC} Undervoltage Lockout Threshold		Rising edge, hysteresis = 1% falling edge		4.5		V
Charge-Mode Detection Threshold		V _{SRC} - V _{B4P}	25		100	mV
Overvoltage Threshold (Note 4)	V _{OV_TH}	MAX1894X cell voltage rising	4.225	4.250	4.275	V
		MAX1924X, MAX1924V cell voltage rising	4.325	4.350	4.375	
Overvoltage Threshold Hysteresis	V _{OV_HYT}	MAX1924X, MAX1924V cell voltage falling		200		mV
Undervoltage Threshold (Note 4)	V _{UV_TH}	Cell voltage falling	2.260	2.300	2.340	V
PKN to BN Discharge Current Fault Threshold	V _{OD_TH}		130	145	160	mV
PKN to BN Charge Current Fault Threshold	V _{OC_TH}		-120	-100	-80	mV
PKN to BN Discharge Current Fault Threshold, Pack-Short Condition	V _{PS_TH}		385	405	425	mV
Discharge or Charge Current Fault to DSO, CGO, TKO Transition Delay Time	t _{i-DELAY}		2.5	3	3.5	ms
Discharge Current Fault to DSO Transition Time Delay for Pack-Short Condition	t _{p-DELAY}		400	450	500	μs

Advanced Li+ Battery-Pack Protectors

MAX1894/MAX1924

ELECTRICAL CHARACTERISTICS (continued)

($V_{SRC} = V_{B4P} + 0.1V$, each battery cell voltage (V_{CELL}) = 3.6V, $V_{CTL} = V_{SHDN} = V_{PKN}$, $T_A = 0^{\circ}C$ to $+85^{\circ}C$, unless otherwise noted. Typical values are at $T_A = +25^{\circ}C$.)

PARAMETER	SYMBOL	CONDITIONS	MIN	TYP	MAX	UNITS
Charge-Voltage Comparator Threshold for Resetting Discharge-Current Fault Latch		$V_{SRC} - V_{B4P}$	25		100	mV
Discharge-Voltage Comparator Threshold for Resetting Charge-Current Fault Latch		$V_{B4P} - V_{SRC}$	25		100	mV
\overline{DSO} , \overline{CGO} , and \overline{TKO} Sink Current		$V_{SRC} = 12V$, $V_{PIN} = 5V$ (Note 5)	100	200		μA
\overline{DSO} , \overline{CGO} , and \overline{TKO} Source Current		$V_{SRC} = 12V$, $V_{PIN} = 10V$ $V_{CTL} = 3V$ (Note 5)	3.5	5		mA
Under/Overvoltage to \overline{DSO} , \overline{CGO} , \overline{TKO} Transition Delay	tv-DELAY		270	320	370	ms
SHDN, CTL Input High (Note 6)		Rising edge	2.4			V
SHDN, CTL Input Low (Note 6)		Falling edge			1.2	V
SHDN, CTL Input Leakage Current		$PKN = BN$			1	μA
SHDN, CTL Delay to Output Change				50		ns
\overline{DSO} , \overline{CGO} , \overline{TKO} Output High (Note 7)		$V_{B_P} = 4V$, $V_{CTL} = 3V$		-0.1		V
\overline{DSO} , \overline{CGO} , \overline{TKO} Output Low (Note 7)		$V_{B_P} = 4V$		-14		V

Advanced Li+ Battery-Pack Protectors

ELECTRICAL CHARACTERISTICS

($V_{SRC} = V_{B4P} + 0.1V$, each battery cell voltage (V_{CELL}) = 3.6V, $V_{CTL} = V_{SHDN} = V_{PKN}$, $T_A = -40^{\circ}C$ to $+85^{\circ}C$, unless otherwise noted.)

PARAMETER	SYMBOL	CONDITIONS	MIN	TYP	MAX	UNITS
SRC Input Current		$V_{SRC} - V_{B_P} = 1V$			40	μA
Supply Current (Note 1)	I_{SUP}	No faults			50	μA
Shutdown Supply Current	I_{SHDN}	Undervoltage without charge source			2	μA
Charge-Mode Detection Threshold		$V_{SRC} - V_{B4P}$	25		100	mV
Overvoltage Threshold (Note 4)	V_{OV_TH}	MAX1894X cell voltage rising	4.21		4.29	V
		MAX1924X, MAX1924V cell voltage rising	4.32		4.38	
Undervoltage Threshold (Note 4)	V_{UV_TH}	Cell voltage falling	2.24		2.36	V
PKN to BN Discharge-Current Fault Threshold	V_{OD_TH}		120		170	mV
PKN to BN Charge-Current Fault Threshold	V_{OC_TH}		-130		-70	mV
PKN to BN Discharge-Current Fault Threshold, Pack Short Condition	V_{PS_TH}		345		465	mV
Discharge- or Charge-Current Fault to \overline{DSO} , \overline{CGO} , \overline{TKO} Transition Delay Time	$t_{i-DELAY}$		2		4	ms
Discharge-Current Fault to \overline{DSO} Transition Time Delay for Pack Short Condition	$t_{P-DELAY}$		370		480	μs
Charge-Voltage Comparator Threshold for Resetting Discharge-Current Fault Latch		$V_{SRC} - V_{B4P}$	25		100	mV
Discharge-Voltage Comparator Threshold for Resetting Charge-Current Fault Latch		$V_{B4P} - V_{SRC}$	25		100	mV
\overline{DSO} , \overline{CGO} , and \overline{TKO} Sink Current		$V_{SRC} = 12V$, $V_{PIN} = 5V$ (Note 5)	100			μA
\overline{DSO} , \overline{CGO} , and \overline{TKO} Source Current		$V_{SRC} = 12V$, $V_{PIN} = 10V$ $V_{CTL} = 3V$ (Note 5)	3.5			mA
Under/Overvoltage to \overline{DSO} , \overline{CGO} , \overline{TKO} Transition Delay	$t_{V-DELAY}$		270		370	ms
SHDN, CTL Input High (Note 6)		Rising edge	2.4			V
SHDN, CTL Input Low (Note 6)		Falling edge			1.2	V

Note 1: Average current from the top of the battery pack. Measured at V_{CC} .

Note 2: Typical supply current for the top cell during the 0.5ms sampling period.

Note 3: Input bias current for this measurement is valid when all cell voltages are equal and the measurement is made over a time greater than 3 seconds.

Note 4: Each cell voltage is sampled individually and a differential measurement is made ($V_{B4P} - V_{B3P}$, $V_{B3P} - V_{B2P}$, $V_{B2P} - V_{B1P}$, and $V_{B1P} - BN$).

Note 5: V_{PIN} represents $V_{\overline{DSO}}$, $V_{\overline{CGO}}$, or $V_{\overline{TKO}}$.

Note 6: Inputs to SHDN and CTL pins are referred to PKN.

Note 7: Measurements are with respect to V_{SRC} .

Advanced Li+ Battery-Pack Protectors

Typical Operating Characteristics

($T_A = +25^\circ\text{C}$, unless otherwise noted.)

MAX1894/MAX1924

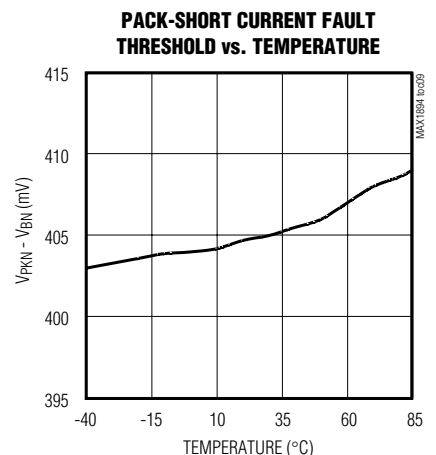
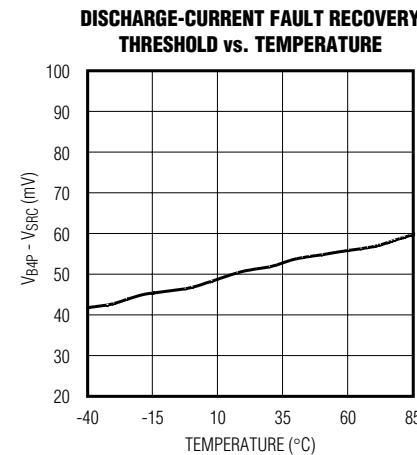
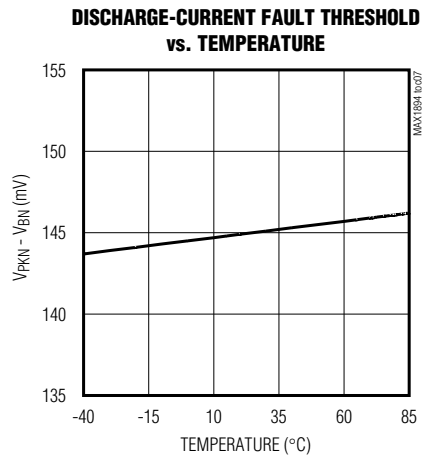
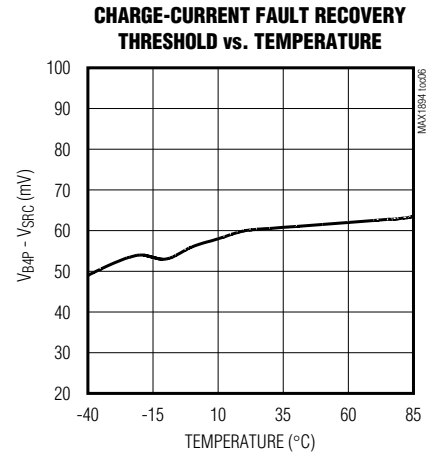
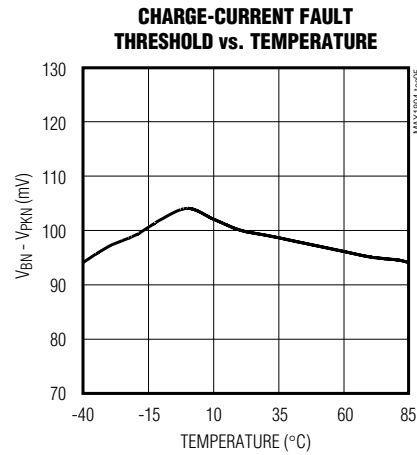
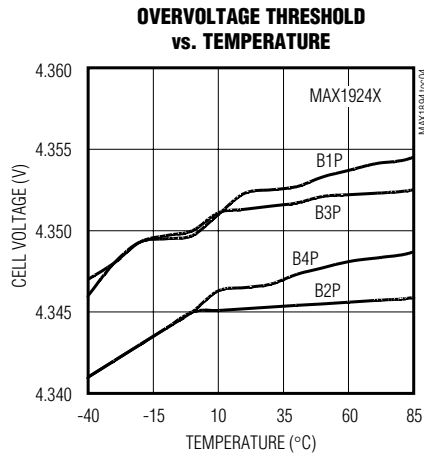
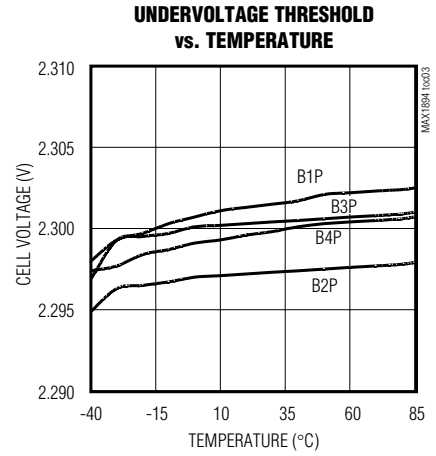
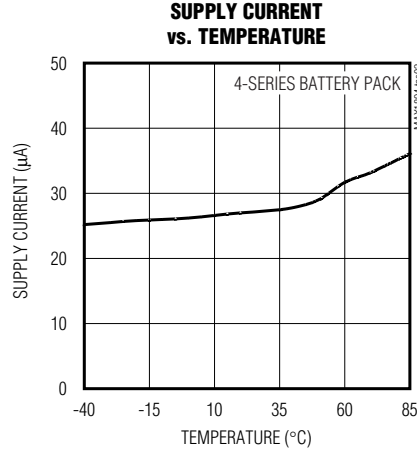
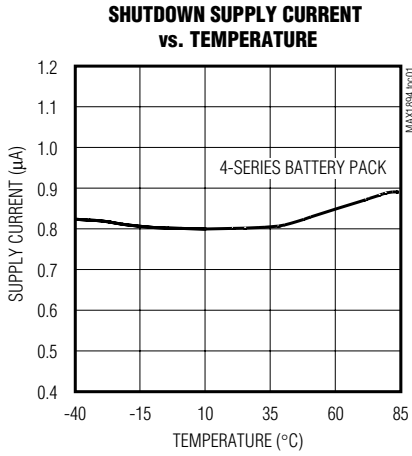

Advanced Li+ Battery-Pack Protectors

Typical Operating Characteristics (continued)

($T_A = +25^\circ\text{C}$, unless otherwise noted.)

DISCHARGE-CURRENT FAULT TIMING

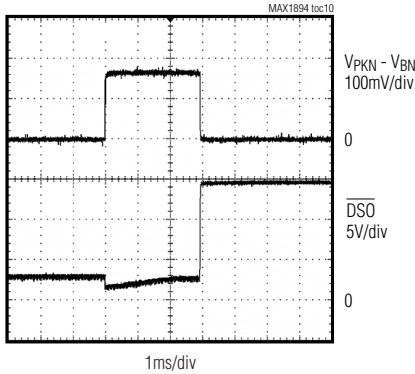

CHARGE-CURRENT FAULT TIMING

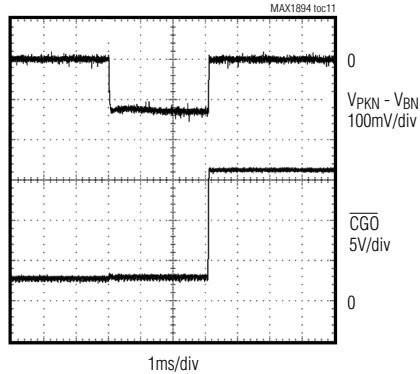

PACK-SHORT CURRENT FAULT TIMING

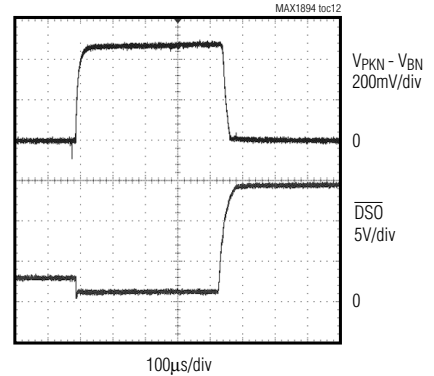

Pin Description

PIN	NAME	FUNCTION
1	B4P	Cell 4 Positive Connection. Short B4P to B3P for MAX1924V.
2	VCC	Supply Input. Connect this pin to the top of the battery pack through a diode and a capacitor (see the <i>Typical Application Circuit</i>).
3	B3P	Cell 3 Positive Connection
4	IC3	Internal Connection. Float this pin.
5	B2P	Cell 2 Positive Connection
6	IC2	Internal Connection. Float this pin.
7	B1P	Cell 1 Positive Connection
8	IC1	Internal Connection. Float this pin.
9	BN	Battery Negative. Connection for the cell 1 negative terminal and the top of the current-sense resistor R_{SENSE} . BN is also chip ground.
10	PKN	Pack Negative. The sense resistor (R_{SENSE}) is connected between BN and PKN.
11	CTL	Control Input. Drive CTL low for normal operation. Drive CTL high to turn off the three external protection MOSFETs.
12	SHDN	Shutdown. Drive SHDN low for normal operation. Drive SHDN high to put the device into shutdown if no charger is present.
13	$\overline{\text{TKO}}$	Trickle-Charge Driver Output. $\overline{\text{TKO}}$ drives the gate of an external P-channel trickle-charge MOSFET low (on) in normal operation.
14	$\overline{\text{CGO}}$	Fast-Charge Driver Output. $\overline{\text{CGO}}$ drives the gate of an external P-channel fast-charge MOSFET low (on) in normal operation.
15	$\overline{\text{DSO}}$	Discharge Driver Output. $\overline{\text{DSO}}$ drives the gate of an external P-channel discharge control MOSFET low (on) in normal operation.
16	SRC	Common Source Connection for MOSFETs. SRC provides the bias for gate drivers $\overline{\text{DSO}}$, $\overline{\text{TKO}}$, and $\overline{\text{CGO}}$.

Advanced Li+ Battery-Pack Protectors

MAX1894/MAX1924

Detailed Description

The MAX1894/MAX1924 battery-pack protectors supervise the charging and discharging process of Li+ cells. Designed for 3-series (MAX1924V) and 4-series (MAX1894X/MAX1924X) applications, these devices monitor the voltage across each cell to provide protection against undervoltage, overvoltage, and overcurrent damage.

Output pins $\overline{\text{CGO}}$, $\overline{\text{TKO}}$, and $\overline{\text{DSO}}$ control external MOSFET gates. These MOSFETs, in turn, control the fast-charging, trickle-charging, and discharge processes of the battery pack (Figure 1).

Modes of Operation

Shutdown Mode

The MAX1894/MAX1924 go into shutdown mode under two conditions: the SHDN pin is driven high without a charger applied, or a battery cell undervoltage fault is detected, also without a charger applied. In shutdown mode, the device consumes 0.8 μA (typ) on the VCC pin and all MOSFETs are off. The MAX1894/MAX1924 stay in shutdown mode as long as no charging voltage is applied to the battery pack (V_{SRC} is less than the pack voltage). When the battery pack is connected to a charger ($V_{\text{SRC}} > V_{\text{B4P}} + 0.1\text{V}$) and the pack voltage is above 4.5V, the device goes into normal operating mode and begins monitoring the pack (see Figure 2).

Normal Mode

In the normal mode of operation, the MAX1894/MAX1924 are in either a standby mode (29 μA typ) or sample mode (160 μA typ). The device enters the standby mode from shutdown mode. The standby mode lasts for 79ms; then the device goes into the sample mode. During sample mode, the MAX1894/MAX1924 check each cell for overvoltage and undervoltage. Sample mode lasts for 0.5ms; then the MAX1894/MAX1924 return to standby mode. During sample mode, the MAX1894/MAX1924 do not introduce cell mismatch.

During normal mode operation, the MAX1894/MAX1924 continuously monitor the voltage across RSENSE for charge or discharge current faults, or battery pack-short faults.

Protection Features

Overvoltage Protection

The MAX1894/MAX1924 provide overvoltage protection to avoid overcharging cells. When an overvoltage fault is detected in four consecutive samples, $\overline{\text{CGO}}$ and $\overline{\text{TKO}}$ go high, stopping the charging process. The MAX1894/MAX1924 continue to sample the cell voltages, and if no overvoltage is detected, $\overline{\text{CGO}}$ and $\overline{\text{TKO}}$

Table 1. Flow Chart Symbol Table

SYMBOL	DESCRIPTION
VOC_TH	Charge-Current Fault Threshold (Negative Value)
VOD_TH	Discharge-Current Fault Threshold
VPS_TH	Pack-Short Discharge-Current Fault Threshold
VUV_TH	Undervoltage Threshold
VOV_TH	Overvoltage Threshold
V_SRC	MOSFET Common Source Voltage
V_RSENSE	Sense Resistor Voltage
VOV_HYT	Overvoltage Threshold Hysteresis
OVF	Overvoltage Sample Counter
UVF	Undervoltage Sample Counter

are returned to the normal low state (see Figure 3). The MAX1924 also includes a hysteresis of 200mV.

The overvoltage threshold is preprogrammed and requires no external components. The overvoltage threshold is factory set at 4.25V (typ) for the MAX1894 and 4.35V (typ) for the MAX1924. Contact Maxim for more information on threshold levels between 4V and 4.4V.

Undervoltage Protection

The MAX1894/MAX1924 provide undervoltage protection to avoid overdischarging the cells. With no battery charger present, and an undervoltage fault is detected in four consecutive samples, $\overline{\text{DSO}}$, $\overline{\text{CGO}}$, and $\overline{\text{TKO}}$ go high and the device goes into shutdown mode (see Figure 4).

If a battery charger is applied to the battery pack and one or more cells are below $V_{\text{UV_TH}}$, then only $\overline{\text{TKO}}$ goes low, allowing trickle-charge current to flow. If no undervoltage is detected in any sample, $\overline{\text{DSO}}$, $\overline{\text{CGO}}$, and $\overline{\text{TKO}}$ all go low.

The undervoltage threshold is preprogrammed at 2.30V (typ). Contact Maxim for more information on threshold levels between 2V and 3.2V.

Charge-Current Fault Protection

The MAX1894/MAX1924 protect against excessive charge current by monitoring the voltage developed across RSENSE. RSENSE is connected between BN and PKN. If V_RSENSE exceeds the charge-current fault threshold (VOC_TH, typically 100mV) for more than 3ms, the charge current comparator is tripped, setting $\overline{\text{CGO}}$ and $\overline{\text{TKO}}$ high.

The charge-current fault condition is latched and is not reset until the MAX1894/MAX1924 detect a reversal in

Advanced Li+ Battery-Pack Protectors

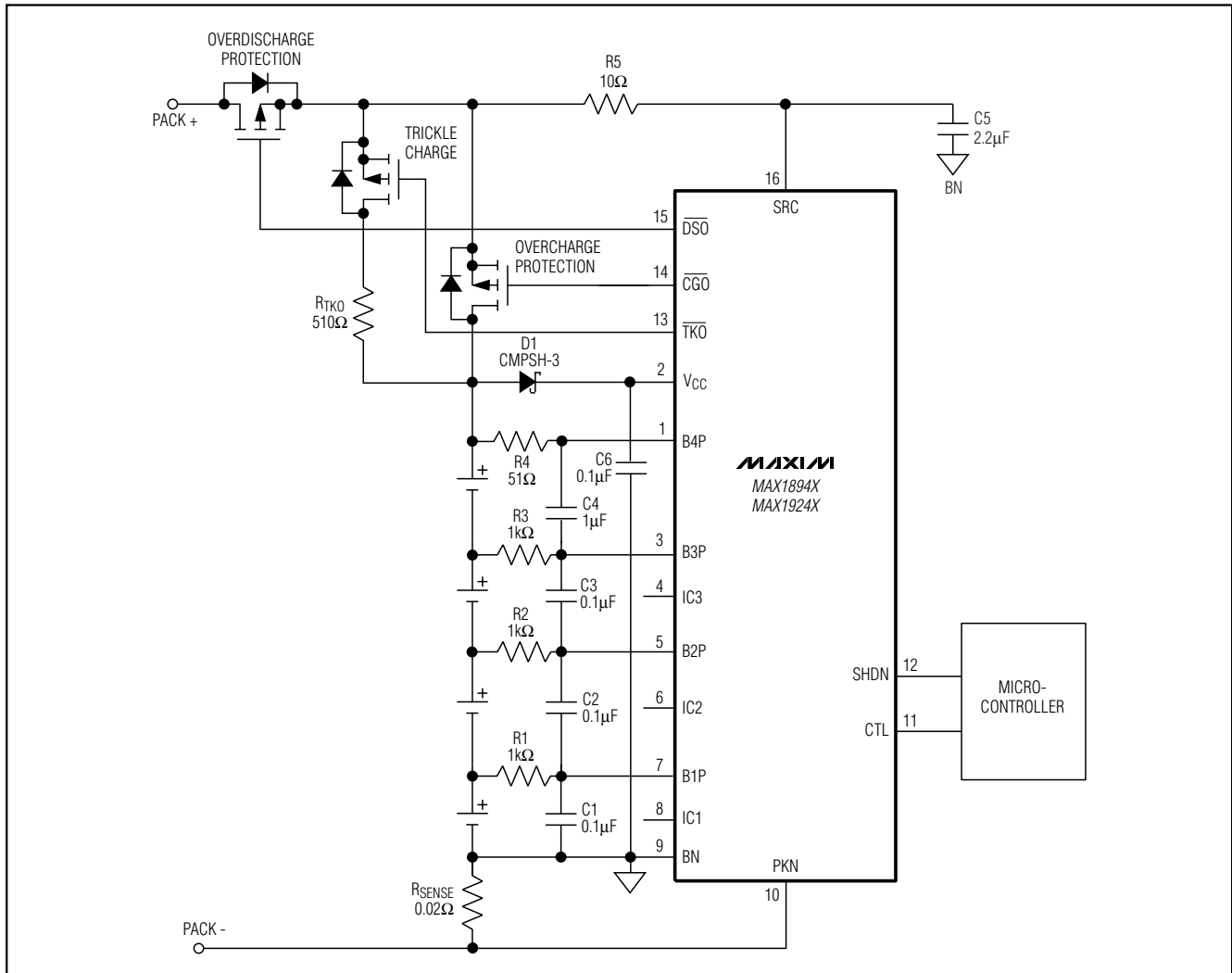

Figure 1. Typical Applications Circuit with Trickle Charge

the direction of current flow. To reverse the current flow, the charger has to be removed (Figure 5). The sustaining condition for the latch is a 100mV (max) voltage drop across SRC and B4P. Since the charge-current fault threshold between BN and PKN is also 100mV (typ), the R_{DS_ON} of the overcharge protection MOSFET must be greater than the sense resistor in order to ensure a latched state.

Discharge-Current Fault Protection

The MAX1894/MAX1924 protect against excessive discharge-current by monitoring the voltage developed across R_{SENSE} . If V_{RSENSE} exceeds the discharge-current fault threshold (V_{OD_TH} , typically 145mV) for more

than 3ms, the discharge-current comparator is tripped, setting \overline{DSO} , \overline{CGO} , and \overline{TKO} high.

Discharge-current fault is latched and is not reset until the MAX1894/MAX1924 detect a reversal in the direction of current flow. To reverse the current flow, a charger must be applied (Figure 6).

Pack-Short Current Fault Protection

The MAX1894/MAX1924 protect against a shorted pack by monitoring the voltage developed across R_{SENSE} . If V_{RSENSE} exceeds the pack-short threshold (V_{PS_TH} , typically 405mV) for more than 450μs, the pack-short comparator is tripped, setting \overline{CGO} , \overline{DSO} , and \overline{TKO} high.

Advanced Li+ Battery-Pack Protectors

MAX1894/MAX1924

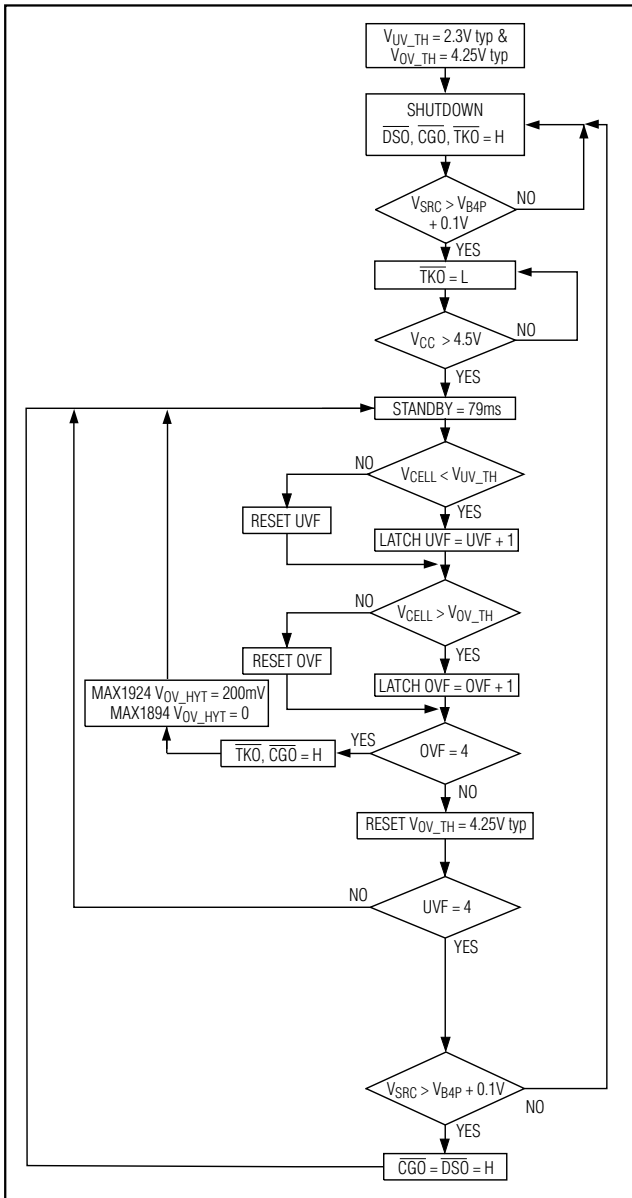

Figure 2. Undervoltage and Overvoltage Protection Flow Chart

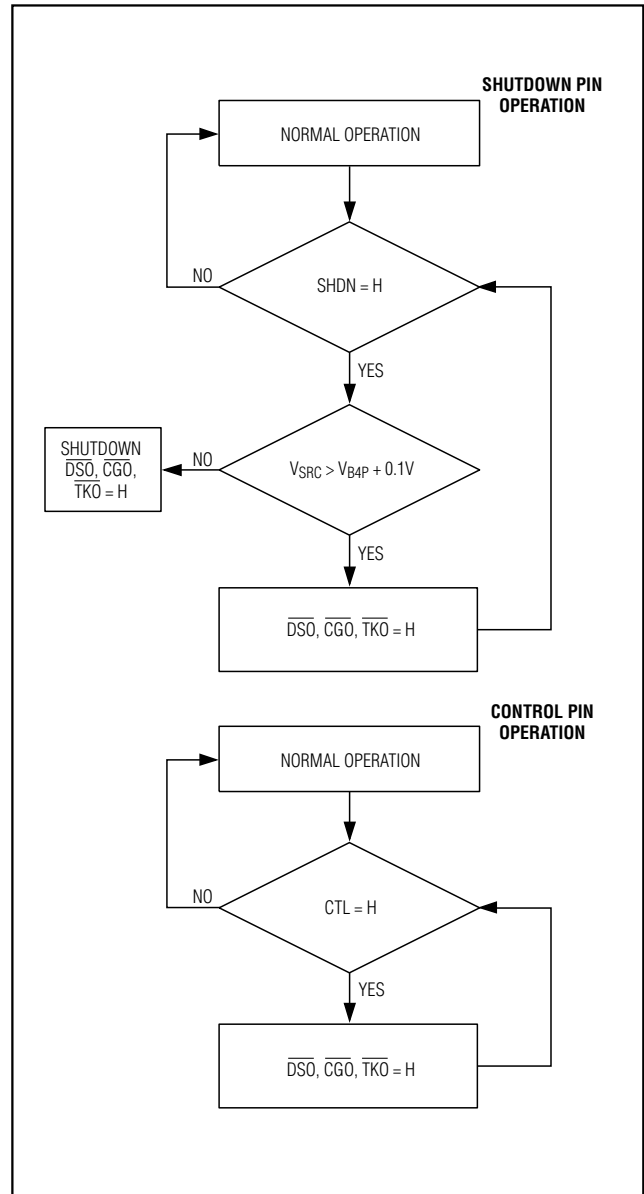

Figure 3. Shutdown and Control Pin Flow Charts

Pack-short current fault is latched and is not reset until the MAX1894/MAX1924 detect a reversal in the direction of current flow. A charger must be applied to reverse the current flow (Figure 7).

Design Procedure

Fast and Trickle-Charge Paths

The MAX1894/MAX1924 offer the designer the flexibility of two charging paths: a fast charging path and a trickle-charge path (see Figure 1). Trickle charging is enabled and $\overline{\text{TKO}}$ is set low when one or more cells are below V_{UV_TH} .

Advanced Li+ Battery-Pack Protectors

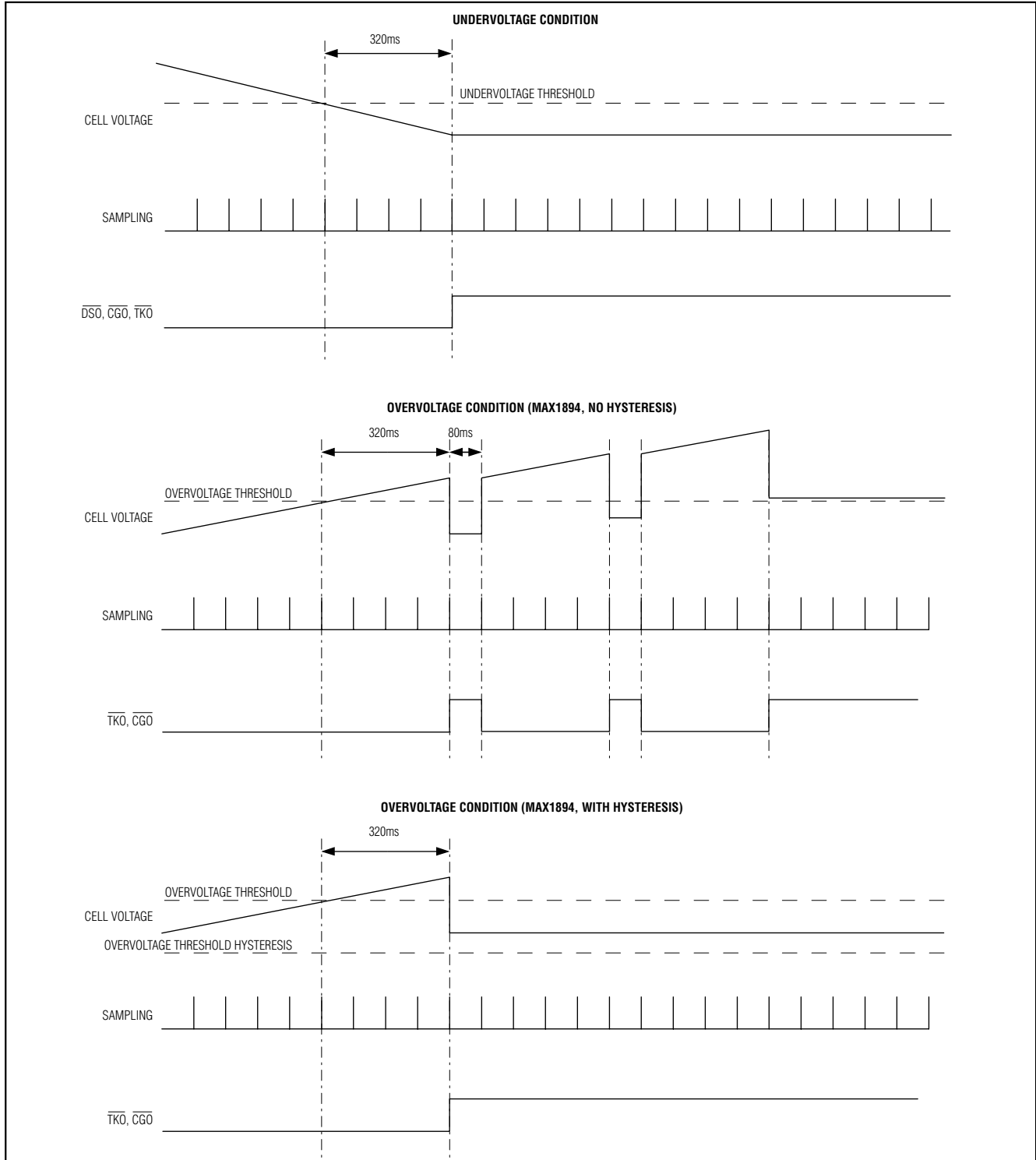

Figure 4. Undervoltage and Overvoltage Timing Diagrams

Advanced Li+ Battery-Pack Protectors

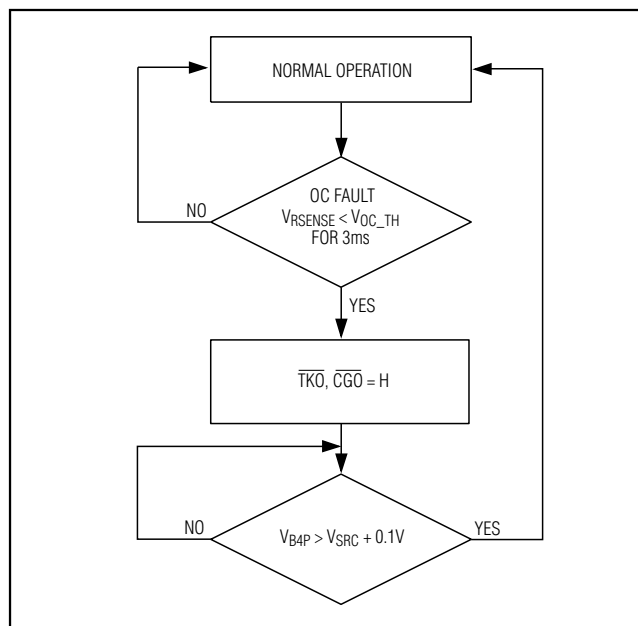

Figure 5. Charge-Current Fault

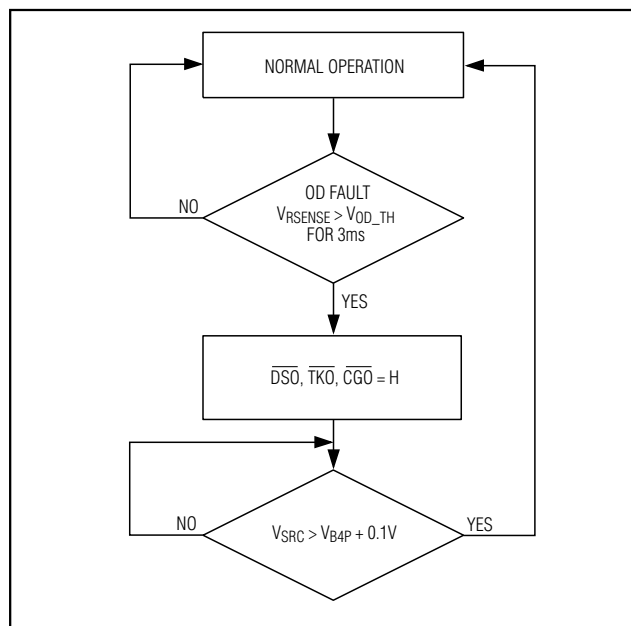

Figure 6. Discharge-Current Fault

Set the nominal values of the trickle charge current by selecting resistor R_{TKO} based on the following equation:

$$R_{TKO} = (V_{CHRG} - V_{PACK}) / I_{TKO}$$

where V_{CHRG} is the charger output voltage, V_{PACK} is the battery-pack voltage, and I_{TKO} is the trickle-charge current.

When the trickle-charge option is not used, float \overline{CGO} and connect \overline{TKO} to the gate of the overcharge protection MOSFET (see Figure 9). When a charger is applied and the voltage on one or more cells is less than V_{UV_TH} , the MAX1894/MAX1924 modulate the \overline{TKO} output until all cells exceed V_{UV_TH} .

Protection FET Drivers

All three external MOSFETs have their source pins connected to the SRC pin. When a MOSFET is turned off, FET drivers pull the gate to the SRC voltage. Additional external pullup resistors are not needed. When the MOSFET is turned on, the V_{GS} is limited to -14V by a clamp circuit built in the drivers. This allows use of MOSFETs with maximum V_{GS} of -20V. All three drivers have the same circuitry and drive capability. The quiescent current in normal operation is less than 3µA per driver.

RSENSE Selection

All current faults are detected using a current-sense resistor connected between BN and PKN. The value of this resistor sets the fault current levels. Charge-current fault is given by:

$$I_{OC_TH} = \frac{V_{OC_TH}}{R_{SENSE}} = \frac{100mV}{R_{SENSE}}$$

Discharge-current fault is given by:

$$I_{OD_TH} = \frac{V_{OC_TH}}{R_{SENSE}} = \frac{145mV}{R_{SENSE}}$$

Pack-short current fault is given by:

$$I_{PS_TH} = \frac{V_{PS_TH}}{R_{SENSE}} = \frac{405mV}{R_{SENSE}}$$

Select R_{SENSE} to obtain the desired fault current levels. For example, a 20mΩ R_{SENSE} sets the charge current fault at 5A. Choose an R_{SENSE} that can withstand the dissipation during normal operation and current fault conditions. For example, pack-short current is given by:

Advanced Li+ Battery-Pack Protectors

Table 2. State Table

STATE	CTL STATE	SHDN STATE	CHARGER APPLIED	GOES INTO SHUTDOWN MODE	$\overline{\text{TKO}}$	$\overline{\text{CGO}}$	$\overline{\text{DSO}}$
Undervoltage	L	L	Yes	No	L	H	H
	L	L	No	Yes	H	H	H
Overvoltage	L	L	X	No	H	H	L
Charge Current Fault	L	L	Yes	No	H	H	L
Discharge Current Fault	L	L	No	No	H	H	H
Pack Short Current Fault	L	L	No	No	H	H	H
Forced Shutdown by External μP	X	H	No	Yes	H	H	H
	X	H	Yes	No	H	H	H
CTL	H	L	X	No	H	H	H
Deep Discharge ($V_{\text{CC}} < 4.5\text{V}$)	L	L	Yes	No	L	H	H
Normal Operation	L	L	X	No	L	L	L

X: Don't care.

$$I_{\text{PS}} = \frac{V_{\text{CELL}} \times N_{\text{S}}}{R_{\text{DSON_DSO}} + R_{\text{DSON_CGO}} + R_{\text{SENSE}} + R_{\text{CELL}} \times \frac{N_{\text{S}}}{N_{\text{P}}}}$$

where N_{S} is the number of cells in series, N_{P} is number of cells in parallel, and V_{CELL} is the cell voltage. Dissipation during pack-short current fault condition is given by:

$$P_{\text{PS}} = (I_{\text{PS}})^2 \times R_{\text{SENSE}}$$

The R_{SENSE} chosen should be able to withstand P_{PS} dissipation. Verify power dissipation in normal operation and other current fault conditions as well.

Choosing External MOSFETs

The external P-channel MOSFETs act as switches to enable or disable charging and discharging of batteries. Different P-channel MOSFETs may be selected depending on the charge and discharge currents anticipated. In most applications, the requirements for fast-charge and discharge MOSFETs are similar and the same type of MOSFETs can be used. The trickle-charge MOSFET can be a small-signal type to minimize cost.

The MAX1894/MAX1924 MOSFET drivers have a V_{GS} clamp of -14V typical and MOSFETs with maximum V_{GS} of -20V can be used. MOSFETs must have a V_{DS} greater than the maximum pack voltage.

The power dissipation in the MOSFETs is given by:

$$P = I^2 R_{\text{DSON}}$$

The MOSFET should be chosen to withstand power dissipation during normal operation and all current fault conditions. Additional MOSFETs can be added in parallel to help these requirements. Table 3 lists some suitable MOSFETs in a small SO-8 package.

Decoupling Considerations

The MAX1894/MAX1924 must have a reliable V_{CC} bias to function properly. A severe overload, such as a short circuit at the pack terminals, can collapse the battery-pack voltage below the V_{CC} undervoltage lockout threshold. The use of a diode-capacitor peak detector on the V_{CC} input ensures continued operation during voltage transients on the battery (Figure 1). Since the MAX1894/MAX1924 typically consume only 30 μA , D1 and C6 can be small, low-cost components. A 30V Schottky diode with a few mA current capability and a 0.1 μF capacitor are sufficient.

The MAX1894/MAX1924 continuously monitor the differential voltage between the B4P and SRC inputs to detect the application of a charger. RC filters with similar time constants must be added to both inputs to ensure the differential voltage is not corrupted by noise.

Advanced Li+ Battery-Pack Protectors

MAX1894/MAX1924

Table 3. MOSFET Selection

P-CHANNEL MOSFETS	MAXIMUM DRAIN CURRENT (A)
IRF7404	6.7
IRF7406	5.8
Si4431	5.8
Si4947 (dual)	3.5 EA

Protecting and Filtering Cell Inputs

Resistors in series with each B_P pin are recommended to limit the current in case there is a short between adjacent B_P pins (see Figure 1).

The intermediate cell input bias current is typically 0.5nA. A 1k Ω resistor in series with any intermediate cell moves the overvoltage trip point by typically 0.5mV, which is insignificant compared to the ± 25 mV tolerance in the overvoltage threshold. The top cell input bias current during sampling period is typically 60 μ A. To reduce the voltage change on the top cell input due to sampling current, a filter resistance of 10 Ω to 50 Ω should be added in series with the top cell. To attain the desired filter characteristics, the capacitance across the two top cell input pins should be 1 μ F.

The MAX1894/MAX1924 have internal ESD diodes on each B_P pin for ESD protection up to 2kV. When higher ESD ratings are needed, capacitors (typically 0.1 μ F) can be added across adjacent B_P pins (see Figure 1). The RC filters improve the device immunity to ESD and filter the noise spikes on B1P–B4P to prevent the MAX1894/MAX1924 from being triggered and latched prematurely by noise spikes.

Control Pins SHDN and CTL

SHDN and CTL allow external logic or microprocessors to control the MAX1894/MAX1924 gate drivers. Drive CTL high to turn off the three protection MOSFETs: \overline{DSO} , \overline{CGO} , and \overline{TKO} . Drive SHDN high to force the MAX1894/MAX1924 into shutdown mode (with no charger applied). SHDN and CTL do not affect the state machine. Toggling these two pins does not change the state or reset any fault conditions. If external control circuitry or a microprocessor is not used, connect SHDN and CTL to PKN.

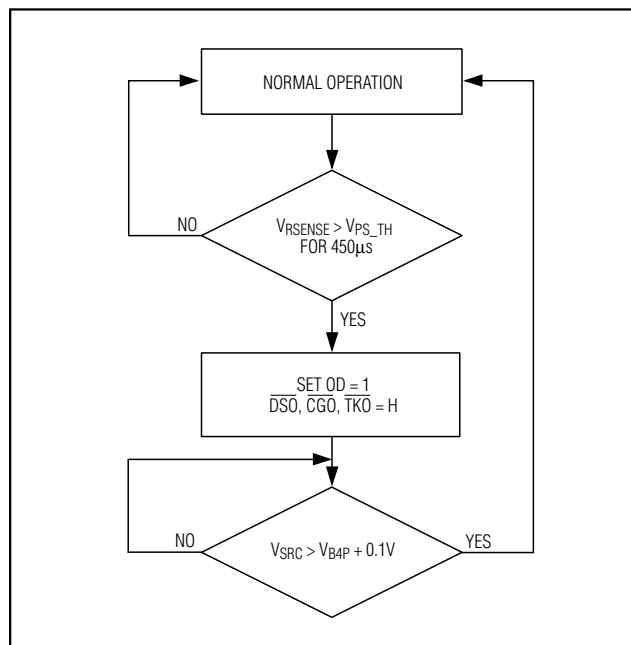

Figure 7. Pack-Short Current Fault

Layout Considerations

Good layout is important to minimize the effects of noise on the system and to ensure accurate voltage and current measurements. Use the appropriate trace widths for the high-current paths and keep traces short to minimize parasitic inductance and capacitance. Minimize current-sense resistor trace lengths and make use of Kelvin connections to the resistor. Provide adequate space and board area for the external MOSFETs and sense resistor to dissipate the heat required. Place RC filters close to B1P–B4P pins.

Chip Information

TRANSISTOR COUNT: 4259

Advanced Li+ Battery-Pack Protectors

MAX1894/MAX1924

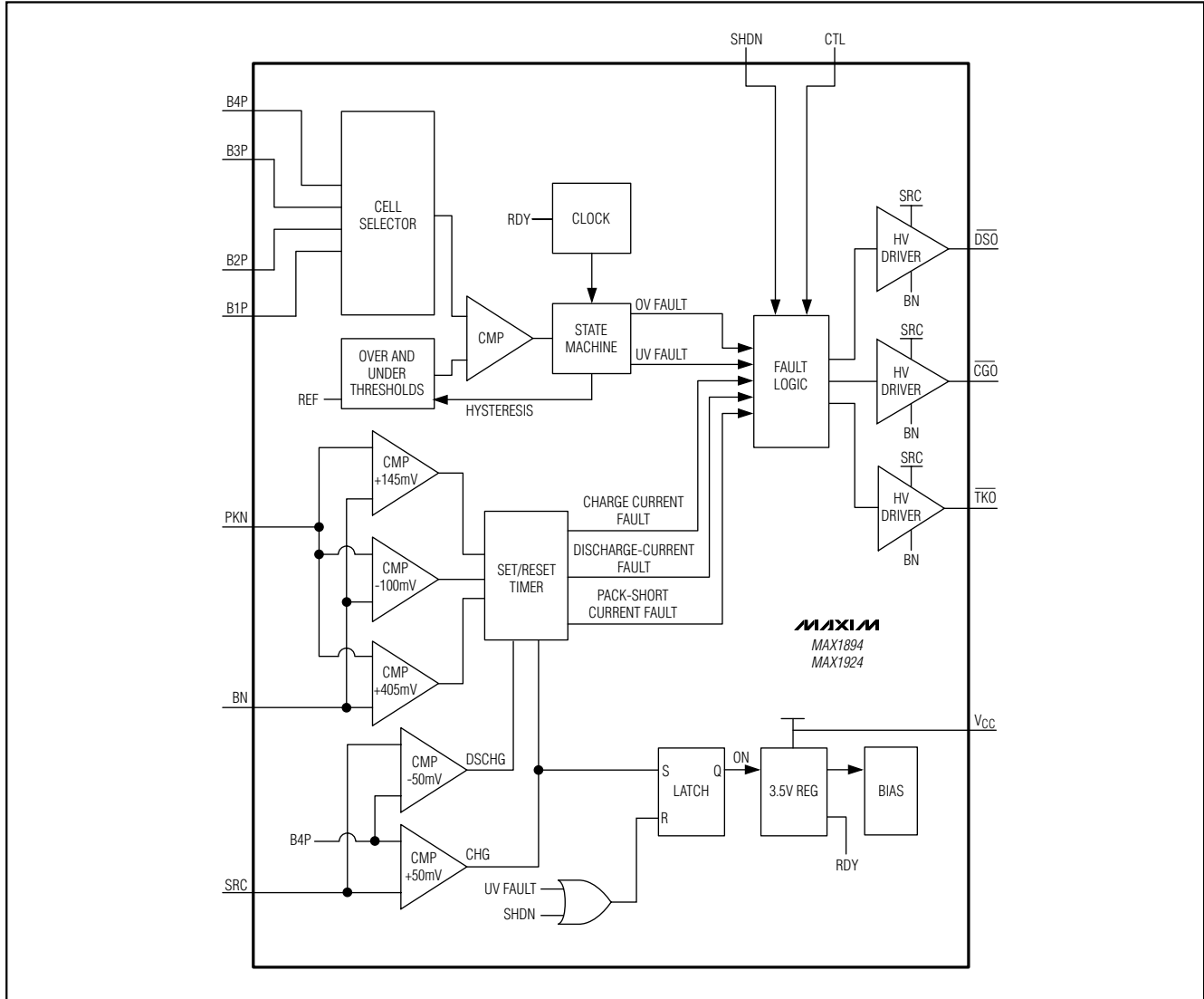

Figure 8. Simplified Functional Diagram

Advanced Li+ Battery-Pack Protectors

MAX1894/MAX1924

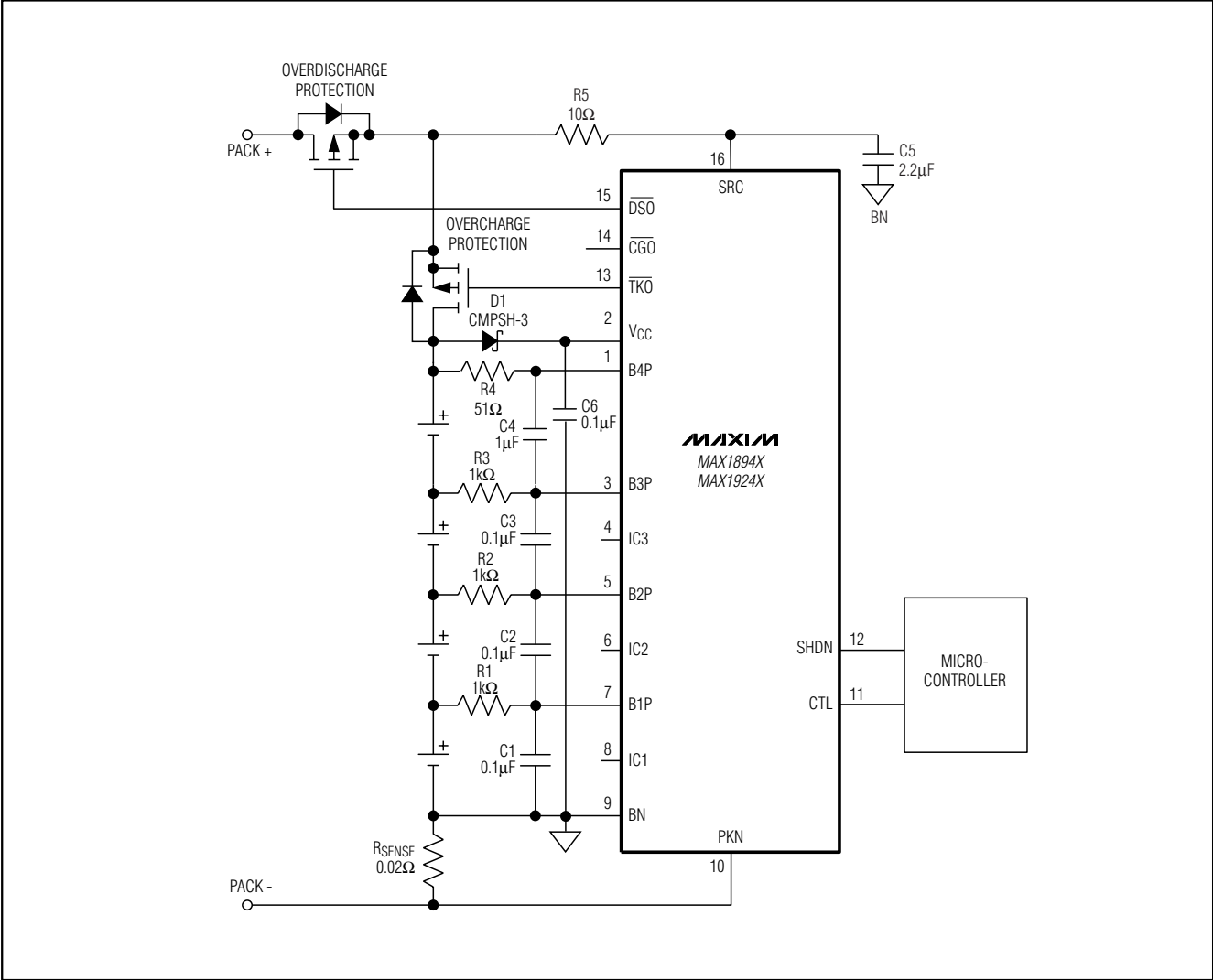

Figure 9. Typical Applications Circuit without Trickle Charge

Advanced Li+ Battery-Pack Protectors

Package Information

(The package drawing(s) in this data sheet may not reflect the most current specifications. For the latest package outline information, go to www.maxim-ic.com/packages.)

DIM	INCHES		MILLIMETERS	
	MIN	MAX	MIN	MAX
A	.061	.068	1.55	1.73
A1	.004	.0098	0.102	0.249
A2	.055	.061	1.40	1.55
B	.008	.012	0.20	0.31
C	.0075	.0098	0.191	0.249
D	SEE VARIATIONS			
E	.150	.157	3.81	3.99
e	.025 BSC		0.635 BSC	
H	.230	.244	5.84	6.20
h	.010	.016	0.25	0.41
L	.016	.035	0.41	0.89
N	SEE VARIATIONS			
α	0°	8°	0°	8°

VARIATIONS:

DIM	INCHES		MILLIMETERS		N
	MIN.	MAX.	MIN.	MAX.	
D	.189	.196	4.80	4.98	16 AA
S	.0020	.0070	0.05	0.18	
D	.337	.344	8.56	8.74	20 AB
S	.0500	.0550	1.270	1.397	
D	.337	.344	8.56	8.74	24 AC
S	.0250	.0300	0.635	0.762	
D	.386	.393	9.80	9.98	28 AD
S	.0250	.0300	0.635	0.762	

NOTES:

- 1). D & E DO NOT INCLUDE MOLD FLASH OR PROTRUSIONS.
- 2). MOLD FLASH OR PROTRUSIONS NOT TO EXCEED .006" PER SIDE.
- 3). CONTROLLING DIMENSIONS: INCHES.
- 4). MEETS JEDEC MO137.

PROPRIETARY INFORMATION

TITLE: PACKAGE OUTLINE, QSDP, .150", .025" LEAD PITCH

APPROVAL	DOCUMENT CONTROL NO.	REV	1/1
	21-0055	D	

QSDP/EPS

Maxim cannot assume responsibility for use of any circuitry other than circuitry entirely embodied in a Maxim product. No circuit patent licenses are implied. Maxim reserves the right to change the circuitry and specifications without notice at any time.

16 **Maxim Integrated Products, 120 San Gabriel Drive, Sunnyvale, CA 94086 408-737-7600**