

Low-Power Audio Amplifier for Telephone Applications

Description

The integrated circuit, U4083B, is a low power audio amplifier for a telephone loudspeaker. It has differential speaker outputs to maximize the output swing at low supply voltages. There is no need for coupler capacitors.

The U4083B has an open loop gain of 80 dB whereas the closed loop gain is adjusted with two external resistors. A chip disable pin permits powering down and/or muting the input signal.

Features

- Wide operating voltage range: 2 to 16 V
- Battery powered application due to low quiescent supply current: 2.7 mA typical
- Chip disable input to power down the integrated circuit
- Low power down quiescent current
- Drives a wide range of speaker loads

- Output Power, $P_o = 250 \text{ mW} @ R_L = 32 \Omega$ (speaker)
- Low harmonic distortion (0.5% typical)
- Wide range gain adjustable: 0 dB to 46 dB

Benefits

- Low number of external components
- Low current consumption

Block Diagram / Application Circuit

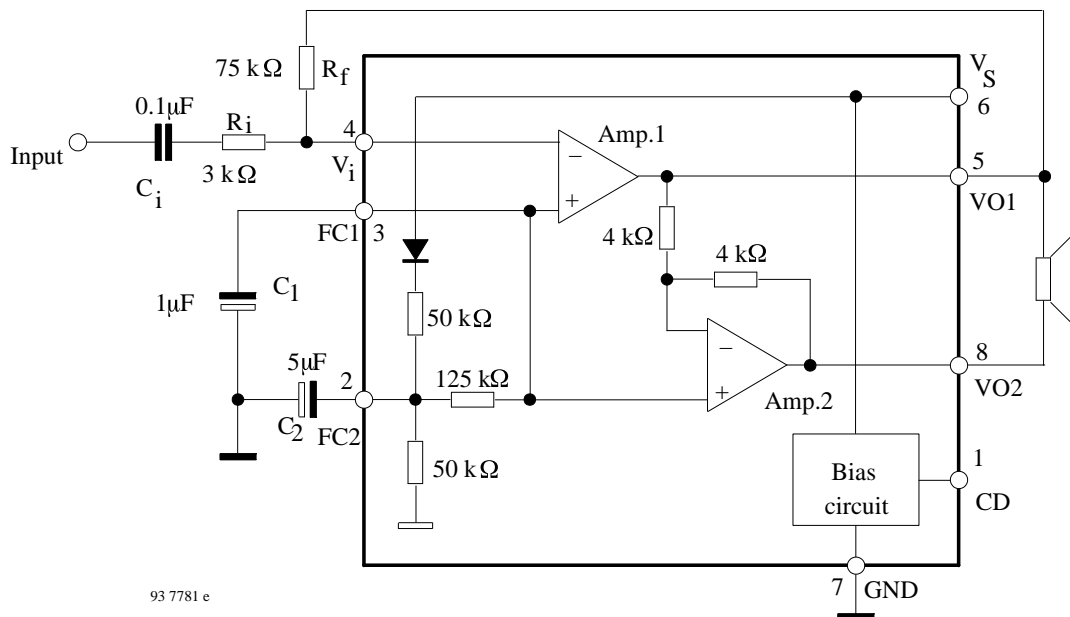

93 7781 e

Figure 1.

Order Information

Extended Type Number	Package	Remarks
U4083B-AFP	SO8	
U4083B-AFPG3	SO8	Taped and reeled

Pin Description

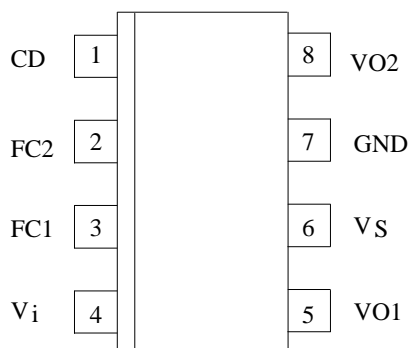

Figure 2. Pinning

94 8022

Pin	Symbol	Function
1	CD	Chip disable
2	FC2	Filtering, power supply rejection
3	FC1	Filtering, power supply rejection
4	V_i	Amplifier input
5	VO1	Amplifier output 1
6	V_S	Voltage supply
7	GND	Ground
8	VO2	Amplifier output 2

Functional Description Including External Circuitry

Pin 1: Chip disable – digital input (CD)

Pin 1 (chip disable) is used to power down the IC to conserve power or muting or both.

Input impedance at pin 1 is typically 90 k Ω .

Logic 0 < 0.8 V IC enabled (normal operation)
 Logic 1 > 2 V IC disabled

Figure 15 shows power supply current diagram. The change in differential gain from normal operation to muted operation (muting) is more than 70 dB.

Switching characteristics are as follows:

turn-on time $t_{on} = 12$ to 15 ms
 turn-off time $t_{off} \leq 2 \mu s$

They are independent of C_1 , C_2 and V_S .

Voltages at Pins 2 and 3 are supplied from V_S and therefore do not change when the U4083B is disabled. Outputs– V_{O1} (Pin 5) and V_{O2} (Pin 8) –turn to a high impedance condition by removing the signal from the speaker.

When signals are applied from an external source to the outputs (disabled), they must not exceed the range between the supply voltage, V_S , and Ground.

Pins 2 and 3: Filtering, power supply rejection

Power supply rejection is provided by capacitors C_1 and C_2 at Pin 3 and Pin 2, respectively. C_1 is dominant at high frequencies whereas C_2 is dominant at low frequencies (figures 4 to 7). Values of C_1 and C_2 depend on the conditions of each application. For example, a line powered speakerphone (telephone amplifier) will require more filtering than a system powered by regulated power supply.

The amount of rejection is a function of the capacitors and the equivalent impedance looking into Pin 3 and Pin 2

(see electrical characteristic equivalent resistance, R).

Apart from filtering, capacitors C_1 and C_2 also influence the turn-on time of the circuit at power-up since capacitors are charged up through the internal resistors (50 k Ω and 125 k Ω) as shown in the block diagram.

Figure 1 shows turn-on time versus C_2 at $V_S = 6$ V, for two different C_1 values.

Turn-on time is 60% longer when $V_S = 3$ V and 20% shorter when $V_S = 9$ V.

Turn-off time is less than 10 μs

Pin 4: Amplifier input V_i
Pin 5: Amplifier output 1 V_{O1}
Pin 8: Amplifier output 2 V_{O2}

There are two identical operational amplifiers. Amp.1 has an open loop gain ≥ 80 dB at 100 Hz (figure 2), whereas the closed loop gain is set by external resistors, R_f and R_i (figure 3). The amplifier is unity gain stable, and has a unity gain frequency of approximately 1.5 MHz. A closed loop gain of 46 dB is recommended for a frequency range of 300 to 3400 Hz (voice band). Amp.2 is internally set to a gain of –1.0 (0 dB). The outputs of both amplifiers are capable of sourcing and sinking a peak current of 200 mA. Output voltage swing is between 0.4 V and $V_S - 1.3$ V at maximum current (figures 18 and 19).

The output dc offset voltage between Pins 5 and 8 ($V_{O1} - V_{O2}$) is mainly a function of the feedback resistor, R_f , because the input offset voltage of the two amplifiers generally neutralize each other.

Bias current of Amp. 1 which is constant with respect to V_S , however flows out of Pin 4 (V_i) and through R_f , forcing V_{O1} to shift negative by an amount equal to $R_f I_{IB}$ and V_{O2} positive to an equal amount.

The output offset voltage specified in the electrical characteristics is measured with the feedback resistor ($R_f = 75$ k Ω) shown in typical application circuit. It takes into account bias current as well as internal offset voltages of the amplifiers.

Pin 6: Supply and power dissipation

Power dissipation is shown in figures 8 to 10 for different loads. Distortion characteristics are given in figures 11 to 13.

$$P_{\text{totmax}} = \frac{T_{\text{jmax}} - T_{\text{amb}}}{R_{\text{thJA}}}$$

where

T_{jmax} = Junction temperature = 140°C

T_{amb} = Ambient temperature

R_{thJA} = Thermal resistance, junction-ambient

Power dissipated within the IC in a given application is found from the following equation:

$$P_{\text{tot}} = (V_S \cdot I_S) + (I_{\text{RMS}} \cdot V_S) - (R_L \cdot I_{\text{RMS}}^2)$$

I_S is obtained from figures 15

I_{RMS} is the RMS current at the load R_L .

Operating range of the integrated circuit is defined with a peak operating load current of ± 200 mA (figures 8 to 13). It is further specified with respect to different loads in figure 14. The left (ascending) portion of each of the three curves is defined by the power level at which 10% distortion occurs. The center flat portion of each curve is defined by the maximum output current capability of the integrated circuit. The right (descending) portion of each curve is defined by the maximum internal power dissipation of the IC at 25°C. At higher ambient temperatures, the maximum load power must be reduced according to the above mentioned equation.

Layout Considerations

Normally a snubber is not needed at the output of the IC, unlike many other audio amplifiers. However, the PC board layout, stray capacitances, and the manner in which the speaker wires are configured, may dictate otherwise. Generally the speaker wires should be twisted tightly, and be not more than a few cm (or inches) in length.

Absolute Maximum Ratings

Reference point Pin 7, $T_{\text{amb}} = 25^\circ\text{C}$ unless otherwise specified.

Parameters	Symbol	Value	Unit
Supply voltage Pin 6	V_S	-1.0 to +18	V
Voltages Pins 1, 2, 3 and 4		-1.0 to ($V_S + 1.0$)	V
Disabled Pins 5 and 8		-1.0 to ($V_S + 1.0$)	V
Output current Pins 5 and 8		± 250	mA
Junction temperature	T_j	+140	°C
Storage temperature range	T_{stg}	-55 to +150	°C
Ambient temperature range	T_{amb}	-20 to +70	°C
Power dissipation: $T_{\text{amb}} = 60^\circ\text{C}$ SO8	P_{tot}	440	mW

Thermal Resistance

Parameters	Symbol	Value	Unit
Junction ambient SO8	R_{thJA}	180	K/W

Operation Recommendation

Parameters	Symbol	Value	Unit
Supply voltage Pin 6	V_S	2 to 16	V
Load impedance Pins 5 to 8	R_L	8.0 to 100	Ω
Load current	I_L	± 200	mA
Differential gain (5.0 kHz bandwidth)	ΔG	0 to 46	dB
Voltage @ CD Pin 1	V_{CD}	V_S	V
Ambient temperature range	T_{amb}	-20 to +70	°C

Electrical Characteristics

T_{amb} = +25°C, reference point Pin 7, unless otherwise specified

Parameters	Test Conditions / Pins	Symbol	Min.	Typ.	Max.	Unit
Amplifiers (AC Characteristics)						
Open gain loop (Amp. 1, f < 100 Hz)		G _{VOL1}	80			dB
Closed gain loop (Amp. 2)	V _S = 6.0 V, f = 1.0 kHz, R _L = 32 Ω	G _{V2}	-0.35	0	+0.35	dB
Gain bandwidth product		G _{BW}		1.5		MHz
Output power	V _S = 3.0 V, R _L = 16 Ω, d < 10% V _S = 6.0 V, R _L = 32 Ω, d < 10% V _S = 12 V, R _L = 100 Ω, d < 10%	P _o P _o P _o	55 250 400			mW
Total harmonic distortion (f = 1.0 kHz)	V _S = 6.0 V, R _L = 32 Ω, P _o = 125 mW V _S > 3.0 V, R _L = 8 Ω, P _o = 20 mW V _S > 12 V, R _L = 32 Ω, P _o = 200 mW	d d d		0.5 0.5 0.6	1.0	%
Power supply rejection ratio	V _S = 6.0 V, ΔV _S = 3.0 V C ₁ = ∞, C ₂ = 0.01 μF C ₁ = 0.1 μF, C ₂ = 0, f = 1.0 kHz C ₁ = 1.0 μF, C ₂ = 5.0 μF, f = 1.0 kHz	PSRR PSRR PSRR	50	12 52		dB
Muting	V _S = 6.0 V, 1.0 kHz < f < 20 kHz, CD = 2.0 V	G _{MUTE}		>70		dB
Amplifiers (DC Characteristics)						
Output dc level at V _{O1} , V _{O2} R _f = 75 kW	V _S = 3.0 V, R _L = 16 Ω V _S = 6.0 V V _S = 12 V	V _O V _O V _O	1.0	1.15 2.65 5.65	1.25	V
Output high level	I _O = -75 mA, 2.0 V < V _S < 16 V	V _{OH}		V _S -1		V
Output low level	I _O = 75 mA, 2.0 V < V _S < 16 V	V _{OL}		0.16		V
Output dc offset voltage (V _{O1} - V _{O2})	V _S = 6.0 V, R _f = 75 kW, R _L = 32 Ω	ΔV _O	-30	0	+30	mV
Input bias current at V _i	V _S = 6.0 V	-I _{IB}		100	200	nA
Equivalent resistance at Pin 3	V _S = 6.0 V	R	100	150	220	kΩ
Equivalent resistance at Pin 2	V _S = 6.0 V	R	18	25	40	kΩ
Chip disable Pin 1 Input voltage – low Input voltage – high Input resistance	V _S = V _{CD} = 16 V	V _{IL} V _{IH} R _{CD}	2.0	90	175	V V kW
Power supply current	V _S = 3.0 V, R _L = ∞, CD = 0.8 V V _S = 16 V, R _L = ∞, CD = 0.8 V V _S = 3.0 V, R _L = ∞, CD = 2.0 V	I _S I _S I _S		65	100	mA mA μA

Typical Temperature Performance

$T_{amb} = -20$ to $+70^{\circ}\text{C}$

Function	Typical Change	Units
Input bias current at V_i	± 40	$\text{pA}/^{\circ}\text{C}$
Total harmonic distortion $V_S = 6.0\text{ V}$, $R_L = 32\ \Omega$, $P_o = 125\text{ mW}$, $f = 1.0\text{ kHz}$	$+ 0.003$	$\%/^{\circ}\text{C}$
Power supply current $V_S = 3.0\text{ V}$, $R_L = \infty$, $CD = 0\text{ V}$ $V_S = 3.0\text{ V}$, $R_L = \infty$, $CD = 2.0\text{ V}$	$- 2.5$ $- 0.03$	$\mu\text{A}/^{\circ}\text{C}$ $\mu\text{A}/^{\circ}\text{C}$

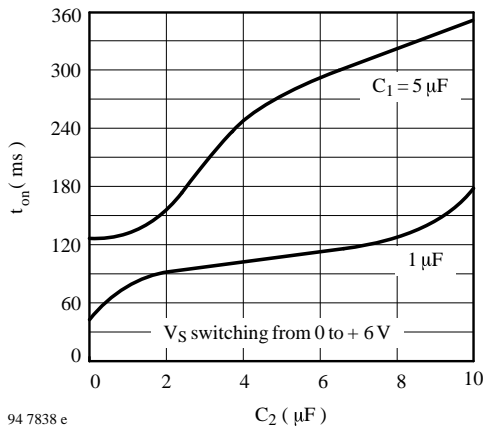

94 7838 e

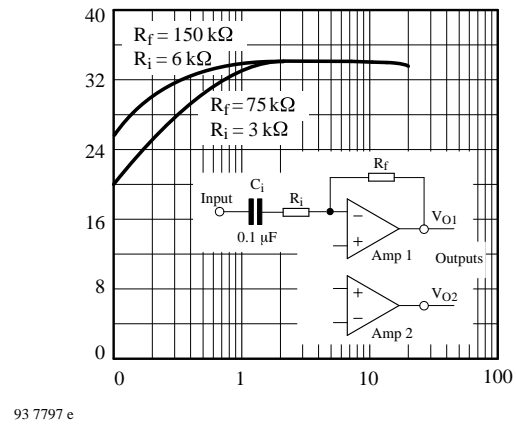

93 7797 e

Figure 1.

Figure 3.

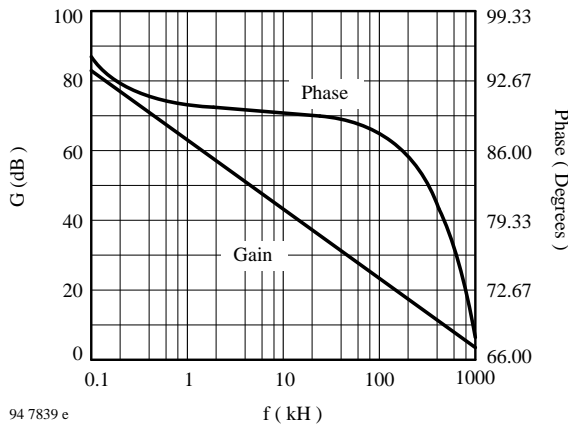

94 7839 e

Figure 2.

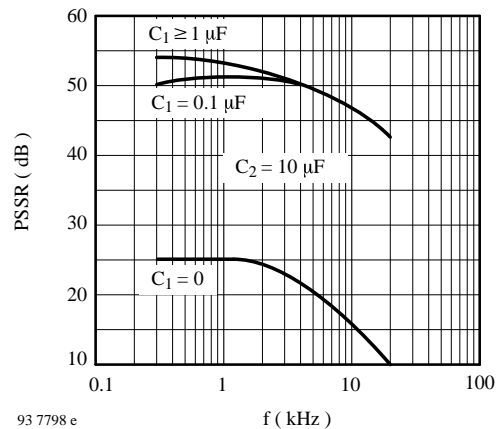

93 7798 e

Figure 4.

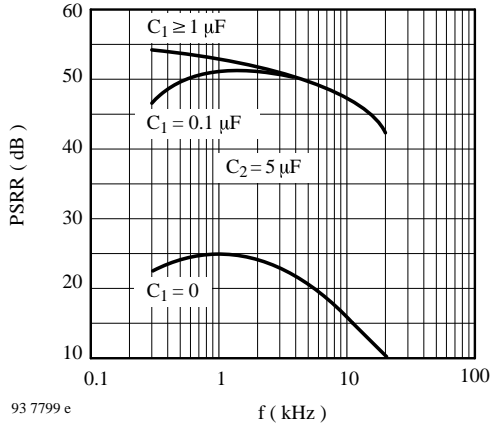

Figure 5.

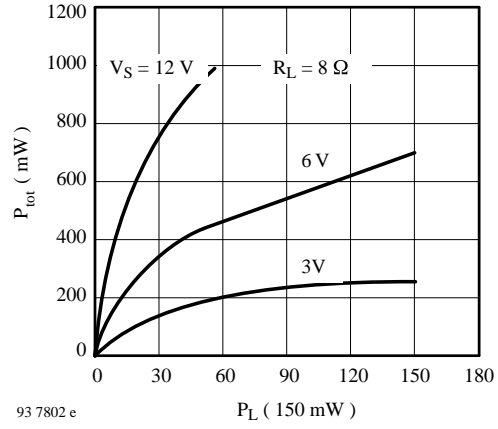

Figure 8.

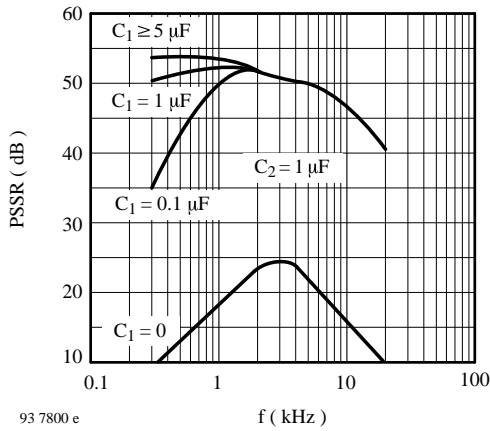

Figure 6.

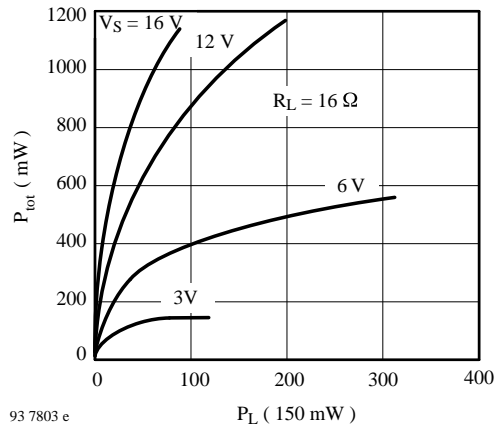

Figure 9.

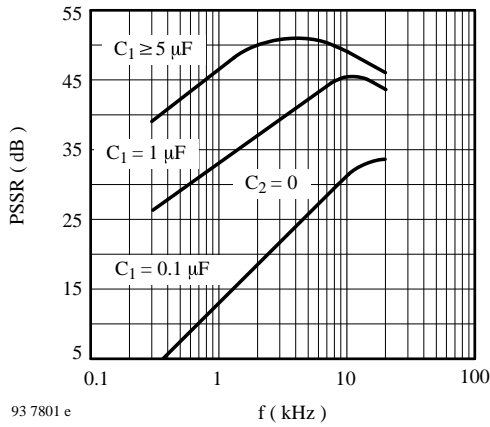

Figure 7.

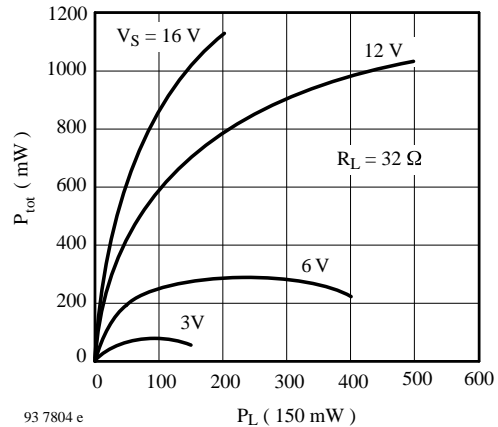

Figure 10.

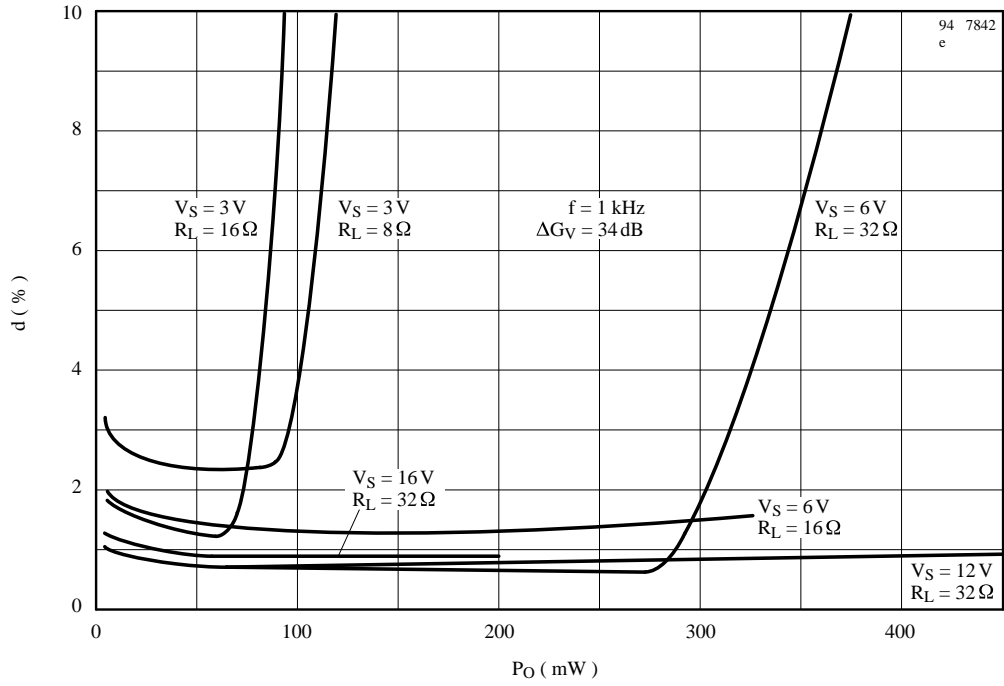

Figure 11.

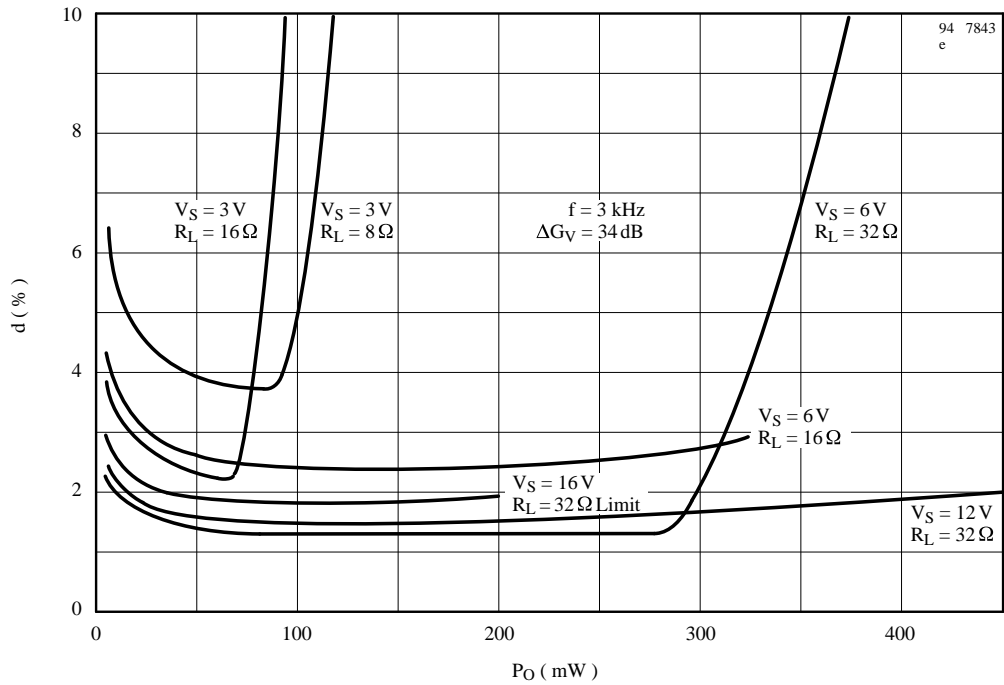

Figure 12.

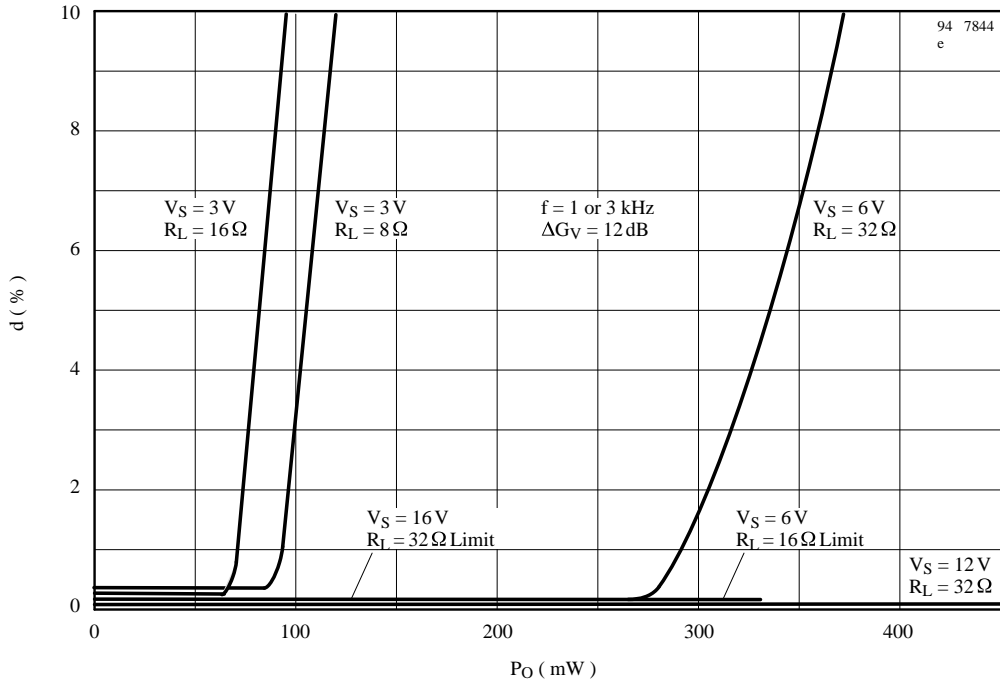

Figure 13.

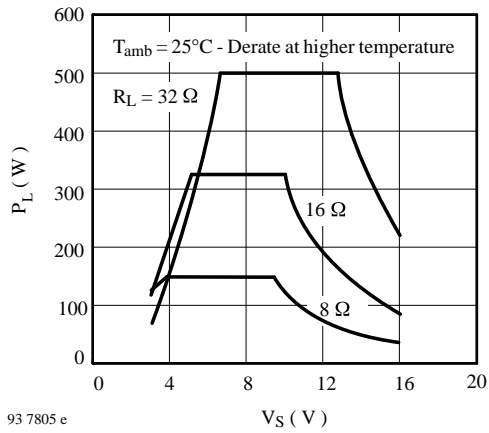

Figure 14.

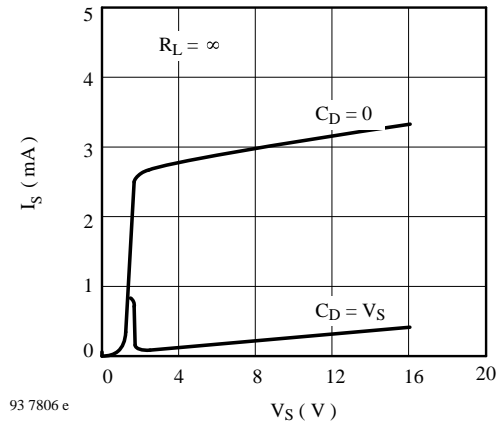

Figure 15.

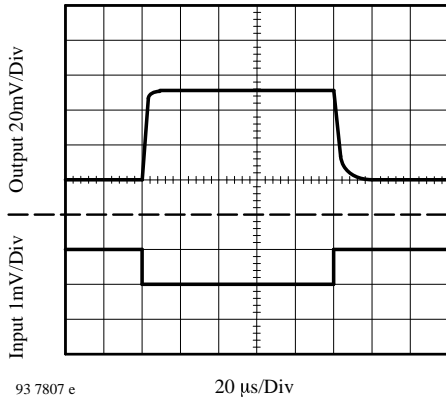

Figure 16.

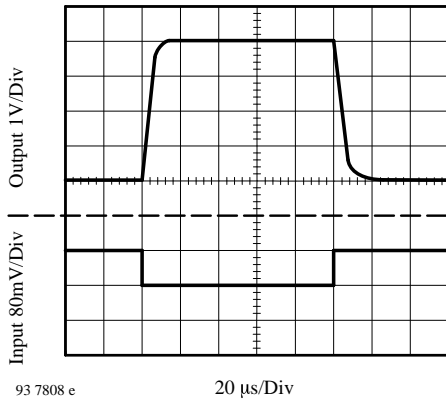

Figure 17.

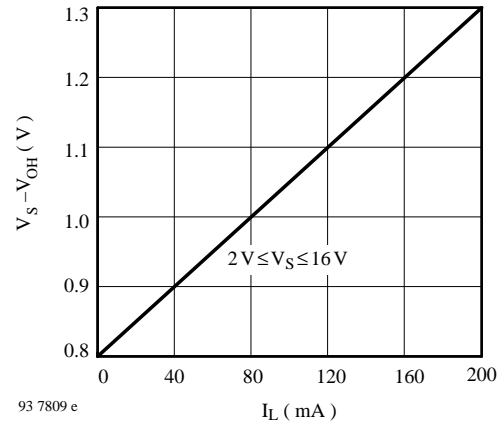

Figure 18.

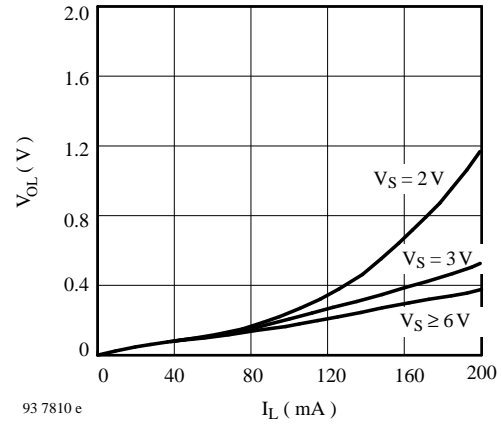
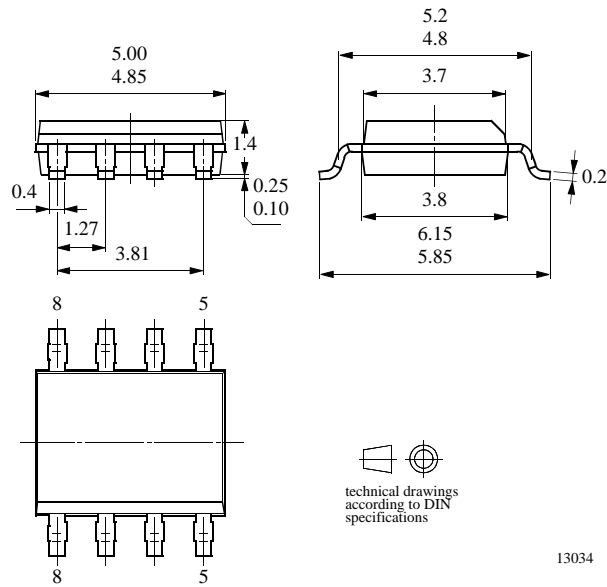

Figure 19.

Package Information

Package SO8

Dimensions in mm



13034

Ozone Depleting Substances Policy Statement

It is the policy of **TEMIC TELEFUNKEN microelectronic GmbH** to

1. Meet all present and future national and international statutory requirements.
2. Regularly and continuously improve the performance of our products, processes, distribution and operating systems with respect to their impact on the health and safety of our employees and the public, as well as their impact on the environment.

It is particular concern to control or eliminate releases of those substances into the atmosphere which are known as ozone depleting substances (ODSs).

The Montreal Protocol (1987) and its London Amendments (1990) intend to severely restrict the use of ODSs and forbid their use within the next ten years. Various national and international initiatives are pressing for an earlier ban on these substances.

TEMIC TELEFUNKEN microelectronic GmbH semiconductor division has been able to use its policy of continuous improvements to eliminate the use of ODSs listed in the following documents.

1. Annex A, B and list of transitional substances of the Montreal Protocol and the London Amendments respectively
2. Class I and II ozone depleting substances in the Clean Air Act Amendments of 1990 by the Environmental Protection Agency (EPA) in the USA
3. Council Decision 88/540/EEC and 91/690/EEC Annex A, B and C (transitional substances) respectively.

TEMIC can certify that our semiconductors are not manufactured with ozone depleting substances and do not contain such substances.

We reserve the right to make changes to improve technical design and may do so without further notice.

Parameters can vary in different applications. All operating parameters must be validated for each customer application by the customer. Should the buyer use TEMIC products for any unintended or unauthorized application, the buyer shall indemnify TEMIC against all claims, costs, damages, and expenses, arising out of, directly or indirectly, any claim of personal damage, injury or death associated with such unintended or unauthorized use.

TEMIC TELEFUNKEN microelectronic GmbH, P.O.B. 3535, D-74025 Heilbronn, Germany
Telephone: 49 (0)7131 67 2831, Fax number: 49 (0)7131 67 2423