



5V/3.3V 64Kx16 CMOS SRAM

Features

- AS7C1026 (5V version)
- AS7C31026 (3.3V version)
- Industrial and commercial versions
- Organization: 65,536 words x 16 bits
- Center power and ground pins for low noise
- High speed
  - 12/15/20 ns address access time
  - 6,7,8 ns output enable access time
- Low power consumption: ACTIVE
  - 880 mW (AS7C1026) / max @ 12 ns
  - 396 mW (AS7C31026) / max @ 12 ns
- Low power consumption: STANDBY
  - 28 mW (AS7C1026) / max CMOS I/O
  - 18 mW (AS7C31026) / max CMOS I/O
- 2.0V data retention
- Easy memory expansion with  $\overline{CE}$ ,  $\overline{OE}$  inputs
- TTL-compatible, three-state I/O
- JEDEC standard packaging
  - 44-pin 400 mil SOJ
  - 44-pin 400 mil TSOP II
  - 48-ball 6 mm x 8 mm CSP mBGA
- ESD protection  $\geq 2000$  volts
- Latch-up current  $\geq 200$  mA

Logic block diagram

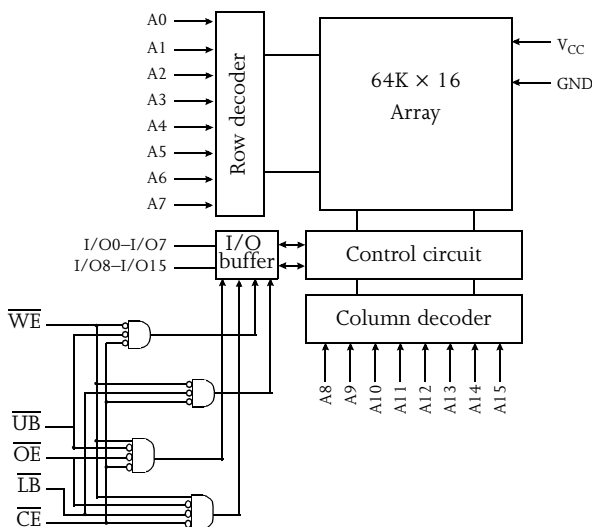

Pin arrangement

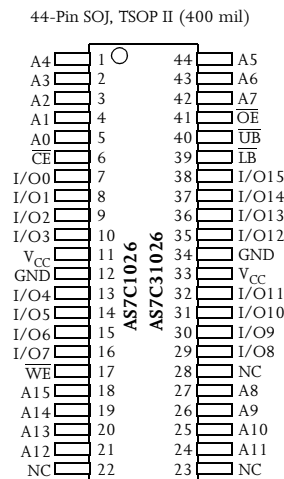

48-CSP mini Ball-Grid-Array Package

	1	2	3	4	5	6
A	$\overline{LB}$	$\overline{OE}$	A <sub>0</sub>	A <sub>1</sub>	A <sub>2</sub>	NC
B	I/O8	$\overline{UB}$	A3	A4	$\overline{CE}$	I/O0
C	I/O9	I/O10	A5	A6	I/O1	I/O2
D	V <sub>SS</sub>	I/O11	NC	A7	I/O3	V <sub>DD</sub>
E	V <sub>DD</sub>	I/O12	NC	NC	I/O4	V <sub>SS</sub>
F	I/O14	I/O13	A14	A15	I/O5	I/O6
G	I/O15	NC	A12	A13	$\overline{WE}$	I/O7
H	NC	A8	A9	A10	A11	NC

Selection guide

		AS7C1026-12 AS7C31026-12	AS7C1026-15 AS7C31026-15	AS7C1026-20 AS7C31026-20	Unit
Maximum address access time		12	15	20	ns
Maximum output enable access time		6	8	10	ns
Maximum operating current	AS7C1026	160	150	140	mA
	AS7C31026	110	100	90	mA
Maximum CMOS standby current	AS7C1026	10	10	15	mA
	AS7C31026	10	10	15	mA

Shaded areas indicate preliminary information.



## Functional description

The AS7C1026 and AS7C31026 are high-performance CMOS 1,048,576-bit Static Random Access Memory (SRAM) devices organized as 65,536 words x 16 bits. They are designed for memory applications where fast data access, low power, and simple interfacing are desired.

Equal address access and cycle times ( $t_{AA}$ ,  $t_{RC}$ ,  $t_{WC}$ ) of 12/15/20 ns with output enable access times ( $t_{OE}$ ) of 6,7,8 ns are ideal for high-performance applications.

When  $\overline{CE}$  is high the devices enter standby mode. The AS7C1026 is guaranteed not to exceed 28 mW power consumption in CMOS standby mode. The devices also offer 2.0V data retention.

A write cycle is accomplished by asserting write enable ( $\overline{WE}$ ) and chip enable ( $\overline{CE}$ ). Data on the input pins I/O0–I/O15 is written on the rising edge of  $\overline{WE}$  (write cycle 1) or  $\overline{CE}$  (write cycle 2). To avoid bus contention, external devices should drive I/O pins only after outputs have been disabled with output enable ( $\overline{OE}$ ) or write enable ( $\overline{WE}$ ).

A read cycle is accomplished by asserting output enable ( $\overline{OE}$ ) and chip enable ( $\overline{CE}$ ), with write enable ( $\overline{WE}$ ) high. The chips drive I/O pins with the data word referenced by the input address. When either chip enable or output enable is inactive, or write enable is active, output drivers stay in high-impedance mode.

The devices provide multiple center power and ground pins, and separate byte enable controls, allowing individual bytes to be written and read.  $\overline{LB}$  controls the lower bits, I/O0–I/O7, and  $\overline{UB}$  controls the higher bits, I/O8–I/O15.

All chip inputs and outputs are TTL-compatible, and operation is from a single 5V supply (AS7C1026) or 3.3V supply (AS7C31026). The device is packaged in common industry standard packages. Chip scale BGA packaging, easy to use in manufacturing, provides the smallest possible footprint. This 48-ball JEDEC-registered package has a ball pitch of 0.75 mm and external dimensions of 8 mm × 6 mm.

## Absolute maximum ratings

Parameter		Symbol	Min	Max	Unit
Voltage on $V_{CC}$ relative to GND	AS7C1026	$V_{t1}$	-0.50	+7.0	V
	AS7C31026	$V_{t1}$	-0.50	+5.0	V
Voltage on any pin relative to GND		$V_{t2}$	-0.50	$V_{CC} + 0.50$	V
Power dissipation		$P_D$	–	1.0	W
Storage temperature (plastic)		$T_{stg}$	-65	+150	°C
Ambient temperature with VCC applied		$T_{bias}$	-55	+125	°C
DC current into outputs (low)		$I_{OUT}$	–	20	mA

Note: Stresses greater than those listed under Absolute Maximum Ratings may cause permanent damage to the device. This is a stress rating only and functional operation of the device at these or any other conditions outside those indicated in the operational sections of this specification is not implied. Exposure to absolute maximum rating conditions for extended periods may affect reliability.

## Truth table

$\overline{CE}$	$\overline{WE}$	$\overline{OE}$	$\overline{LB}$	$\overline{UB}$	I/O0–I/O7	I/O8–I/O15	Mode
H	X	X	X	X	High Z	High Z	Standby ( $I_{SB}$ , $I_{SBI}$ )
L	H	L	L	H	$D_{OUT}$	High Z	Read I/O0–I/O7 ( $I_{CC}$ )
L	H	L	H	L	High Z	$D_{OUT}$	Read I/O8–I/O15 ( $I_{CC}$ )
L	H	L	L	L	$D_{OUT}$	$D_{OUT}$	Read I/O0–I/O15 ( $I_{CC}$ )
L	L	X	L	L	$D_{IN}$	$D_{IN}$	Write I/O0–I/O15 ( $I_{CC}$ )
L	L	X	L	H	$D_{IN}$	High Z	Write I/O0–I/O7 ( $I_{CC}$ )



$\overline{CE}$	$\overline{WE}$	$\overline{OE}$	$\overline{LB}$	$\overline{UB}$	I/O0–I/O7	I/O8–I/O15	Mode
L	L	X	H	L	High Z	D <sub>IN</sub>	Write I/O8–I/O15 (I <sub>CC</sub> )
L	H	H	X	X	High Z	High Z	Output disable (I <sub>CC</sub> )
L	X	X	H	H			

Key: H = High, L = Low, X = don't care.

### Recommended operating conditions

Parameter	Device	Symbol	Min	Typ	Max	Unit
Supply voltage	AS7C1026	V <sub>CC</sub>	4.5	5.0	5.5	V
	AS7C31026 (–10)	V <sub>CC</sub>	3.15	3.3	3.6	V
	AS7C31026 (12/15/20)	V <sub>CC</sub>	3.0	3.3	3.6	V
Input voltage	AS7C1026	V <sub>IH</sub>	2.2	–	V <sub>CC</sub> + 0.5	V
	AS7C31026	V <sub>IH</sub>	2.0	–	V <sub>CC</sub> + 0.5	V
		V <sub>IL</sub>	–0.5 <sup>†</sup>	–	0.8	V
Ambient operating temperature	commercial	T <sub>A</sub>	0	–	70	°C
	industrial	T <sub>A</sub>	–40	–	85	°C

<sup>†</sup> V<sub>IL</sub> min = –3.0V for pulse width less than t<sub>RC</sub>/2.

### DC operating characteristics (over the operating range)<sup>1</sup>

Parameter	Sym	Test conditions	Device	–12		–15		–20		Unit
				Min	Max	Min	Max	Min	Max	
Input leakage current	I <sub>LI</sub>	V <sub>CC</sub> = Max V <sub>IN</sub> = GND to V <sub>CC</sub>		–	1	–	1	–	1	μA
Output leakage current	I <sub>LO</sub>	V <sub>CC</sub> = Max $\overline{CE} = V_{IH}$ , V <sub>OUT</sub> = GND to V <sub>CC</sub>		–	1	–	1	–	1	μA
Operating power supply current	I <sub>CC</sub>	V <sub>CC</sub> = Max, $\overline{CE} \leq V_{IL}$ , outputs open, f = f <sub>Max</sub> = 1/t <sub>RC</sub>	AS7C1026	–	160	–	150	–	140	mA
			AS7C31026	–	110	–	100	–	90	mA
Standby power supply current	I <sub>SB</sub>	V <sub>CC</sub> = Max, $\overline{CE} \leq V_{IL}$ , outputs open, f = f <sub>Max</sub> = 1/t <sub>RC</sub>	AS7C1026	–	50	–	50	–	50	mA
			AS7C31026	–	35	–	35	–	35	
	I <sub>SB1</sub>	V <sub>CC</sub> = Max, $\overline{CE} \geq V_{CC} - 0.2V$ , V <sub>IN</sub> ≤ GND + 0.2V or V <sub>IN</sub> ≥ V <sub>CC</sub> – 0.2V, f = 0	AS7C1026	–	10	–	10	–	15	mA
			AS7C31026	–	10	–	10	–	15	
Output voltage	V <sub>OL</sub>	I <sub>OL</sub> = 8 mA, V <sub>CC</sub> = Min		–	0.4	–	0.4	–	0.4	V
	V <sub>OH</sub>	I <sub>OH</sub> = –4 mA, V <sub>CC</sub> = Min		2.4	–	2.4	–	2.4	–	V

Shaded areas indicate preliminary information.

### Capacitance (f = 1MHz, T<sub>a</sub> = 25 °C, V<sub>CC</sub> = NOMINAL)<sup>2</sup>

Parameter	Symbol	Signals	Test conditions	Max	Unit
Input capacitance	C <sub>IN</sub>	A, $\overline{CE}$ , $\overline{WE}$ , $\overline{OE}$ , $\overline{LB}$ , $\overline{UB}$	V <sub>IN</sub> = 0V	5	pF
I/O capacitance	C <sub>I/O</sub>	I/O	V <sub>IN</sub> = V <sub>OUT</sub> = 0V	7	pF



Read cycle (over the operating range)<sup>3,9</sup>

Parameter	Symbol	-12		-15		-20		Unit	Notes
		Min	Max	Min	Max	Min	Max		
Read cycle time	$t_{RC}$	12	–	15	–	20	–	ns	
Address access time	$t_{AA}$	–	12	–	15	–	20	ns	3
Chip enable ( $\overline{CE}$ ) access time	$t_{ACE}$	–	12	–	15	–	20	ns	3
Output enable ( $\overline{OE}$ ) access time	$t_{OE}$	–	6	–	7	–	8	ns	
Output hold from address change	$t_{OH}$	4	–	4	–	4	–	ns	5
$\overline{CE}$ Low to output in low Z	$t_{CLZ}$	0	–	0	–	0	–	ns	4, 5
$\overline{CE}$ High to output in high Z	$t_{CHZ}$	–	6	–	6	–	8	ns	4, 5
$\overline{OE}$ Low to output in low Z	$t_{OLZ}$	0	–	0	–	0	–	ns	4, 5
Byte select access time	$t_{BA}$	–	6	–	7	–	8	ns	
Byte select Low to low Z	$t_{BLZ}$	0	–	0	–	0	–	ns	4,5
Byte select High to high Z	$t_{BHZ}$	–	6	–	6	–	8	ns	4,5
$\overline{OE}$ High to output in high Z	$t_{OHZ}$	–	6	–	6	–	8	ns	4, 5
Power up time	$t_{PU}$	0	–	0	–	0	–	ns	4, 5
Power down time	$t_{PD}$	–	12	–	15	–	20	ns	4, 5

Shaded areas indicate preliminary information.

Key to switching waveforms

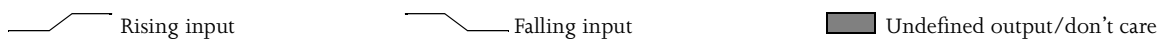

Read waveform 1 (address controlled)<sup>3,6,7,9</sup>

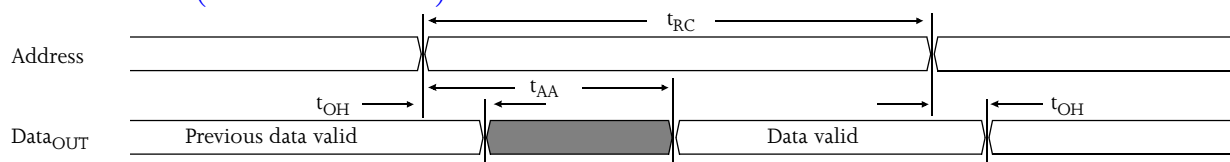

Read waveform 2 ( $\overline{OE}$ ,  $\overline{CE}$ ,  $\overline{UB}$ ,  $\overline{LB}$  controlled)<sup>3,6,8,9</sup>

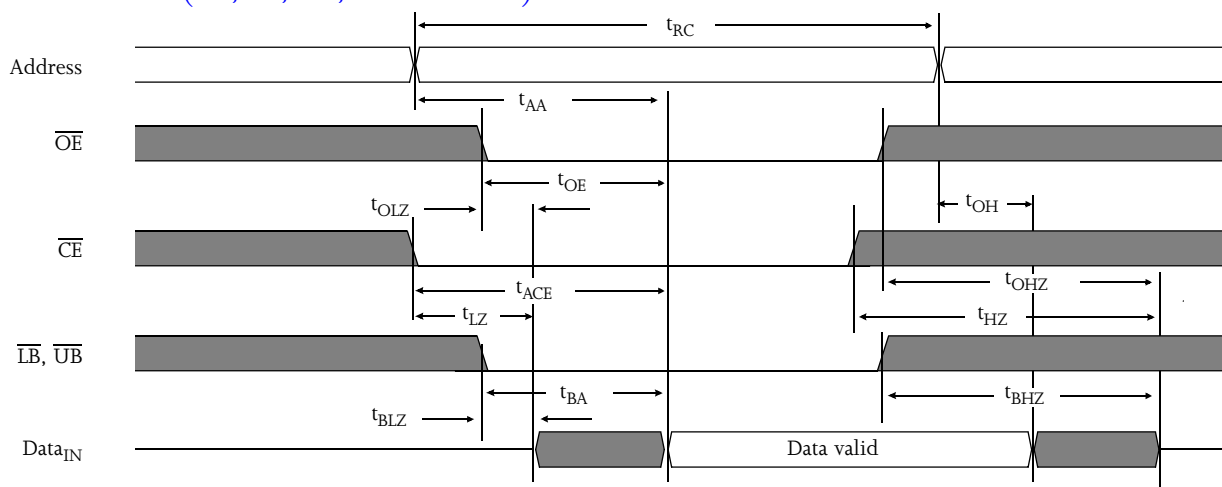



Write cycle (over the operating range) <sup>11</sup>

Parameter	Symbol	-12		-15		-20		Unit	Notes
		Min	Max	Min	Max	Min	Max		
Write cycle time	$t_{WC}$	12	–	15	–	20	–	ns	
Chip enable ( $\overline{CE}$ ) to write end	$t_{CW}$	8	–	12	–	13	–	ns	
Address setup to write end	$t_{AW}$	9	–	10	–	12	–	ns	
Address setup time	$t_{AS}$	0	–	0	–	0	–	ns	
Write pulse width	$t_{WP}$	8	–	10	–	12	–	ns	
Address hold from end of write	$t_{AH}$	0	–	0	–	0	–	ns	
Data valid to write end	$t_{DW}$	6	–	8	–	10	–	ns	
Data hold time	$t_{DH}$	0	–	0	–	0	–	ns	5
Write enable to output in high Z	$t_{WZ}$	–	6	–	6	–	8	ns	4, 5
Output active from write end	$t_{OW}$	1	–	1	–	2	–	ns	4, 5
Byte select low to end of write	$t_{BW}$	8	–	9	–	12	–	ns	

Shaded areas indicate preliminary information.

Write waveform 1 ( $\overline{WE}$  controlled) <sup>10,11</sup>

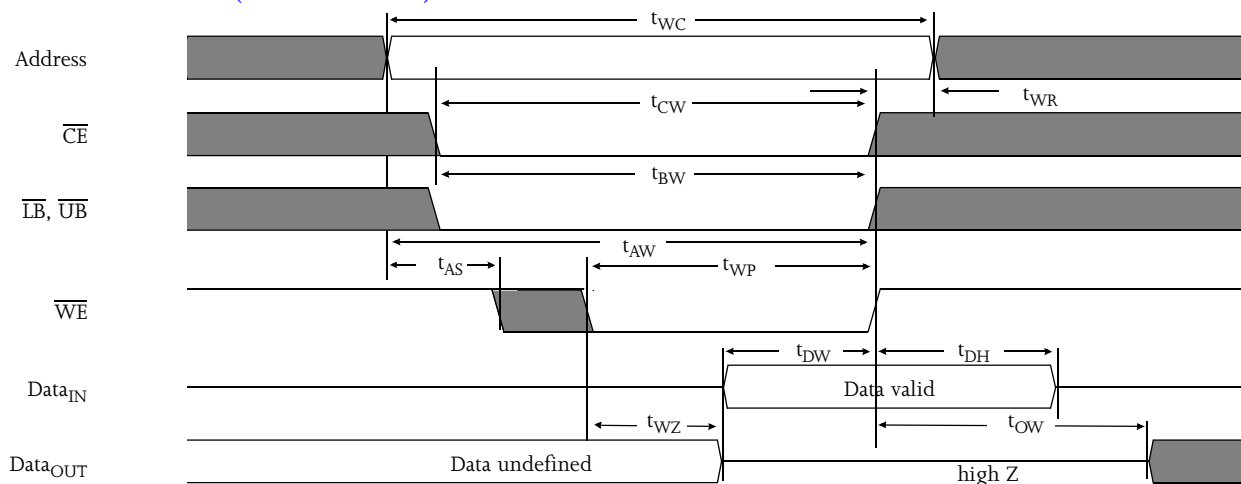

Write waveform 2 ( $\overline{CE}$  controlled) <sup>10,11</sup>

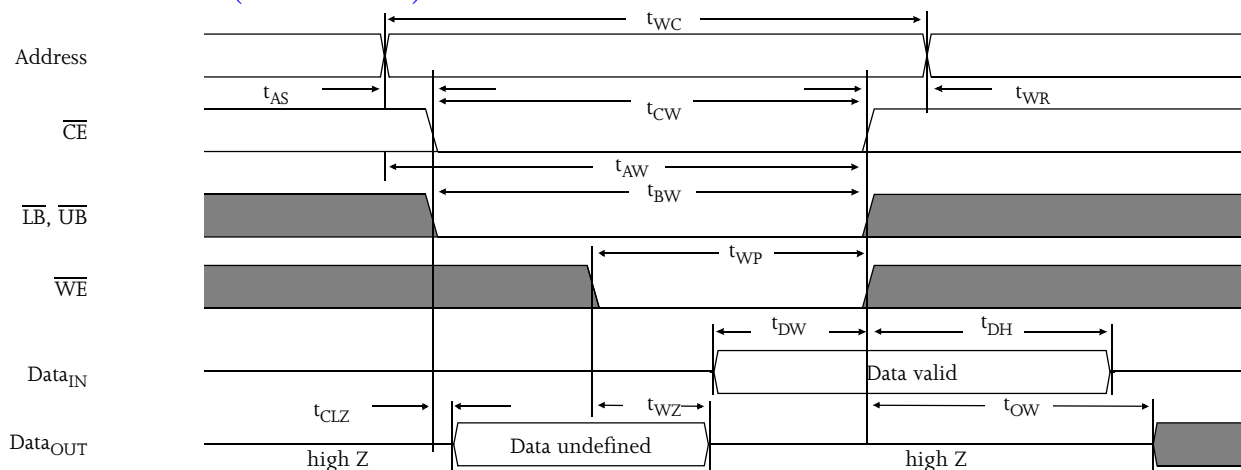



Data retention characteristics (over the operating range)<sup>13</sup>

Parameter	Symbol	Test conditions	Min	Max	Unit
V <sub>CC</sub> for data retention	V <sub>DR</sub>	V <sub>CC</sub> = 2.0V $\overline{CE} \geq V_{CC} - 0.2V$ V <sub>IN</sub> ≥ V <sub>CC</sub> - 0.2V or V <sub>IN</sub> ≤ 0.2V	2.0	–	V
Data retention current	I <sub>CCDR</sub>		–	1	ma
Chip deselect to data retention time	t <sub>CDR</sub>		0	–	ns
Operation recovery time	t <sub>R</sub>		t <sub>RC</sub>	–	ns
Input leakage current	I <sub>LI</sub>		–	1	μA

Data retention waveform

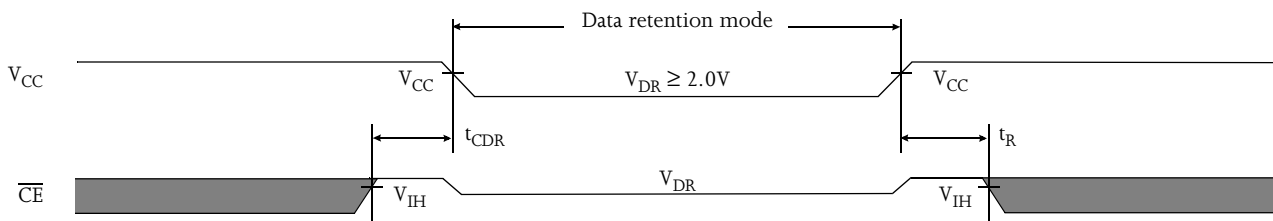

AC test conditions

- Output load: see Figure B or Figure C, except as noted.
- Input pulse level: GND to 3.0V. See Figure A.
- Input rise and fall times: 2 ns. See Figure A.
- Input and output timing reference levels: 1.5V.

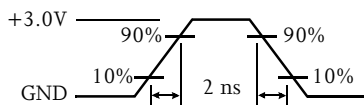

Figure A: Input pulse

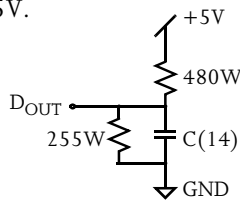

Figure B: 5V Output load

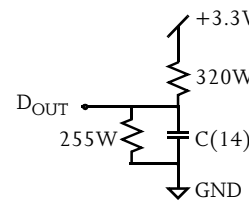
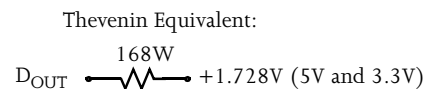

Figure C: 3.3V Output load

Notes

- 1 During V<sub>CC</sub> power-up, a pull-up resistor to V<sub>CC</sub> on  $\overline{CE}$  is required to meet I<sub>GB</sub> specification.
- 2 This parameter is sampled, but not 100% tested.
- 3 For test conditions, see AC Test Conditions, Figures A, B, and C.
- 4 These parameters are specified with C<sub>L</sub> = 5pF, as in Figures B or C. Transition is measured ± 500 mV from steady-state voltage.
- 5 This parameter is guaranteed, but not tested.
- 6  $\overline{WE}$  is High for read cycle.
- 7  $\overline{CE}$  and  $\overline{OE}$  are Low for read cycle.
- 8 Address valid prior to or coincident with  $\overline{CE}$  transition Low.
- 9 All read cycle timings are referenced from the last valid address to the first transitioning address.
- 10  $\overline{CE}$  or  $\overline{WE}$  must be High during address transitions. Either  $\overline{CE}$  or  $\overline{WE}$  asserting high terminates a write cycle.
- 11 All write cycle timings are referenced from the last valid address to the first transitioning address.
- 12 Not applicable.
- 13 2V data retention applies to commercial temperature range operation only.
- 14 C=30pF, except all high Z and low Z parameters where C=5pF.



Typical DC and AC characteristics

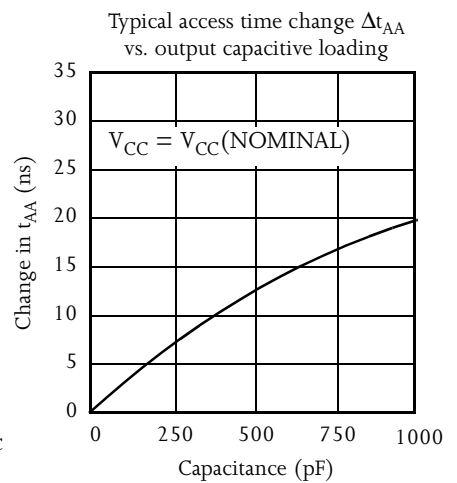
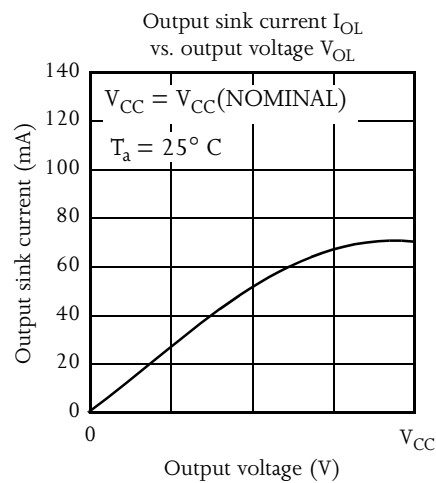
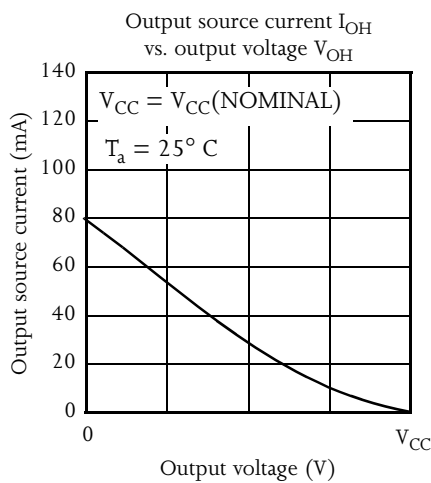
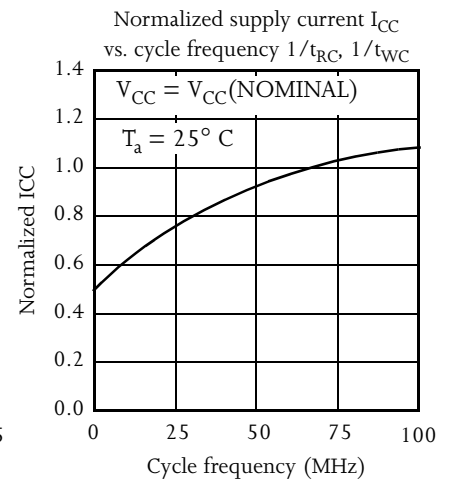
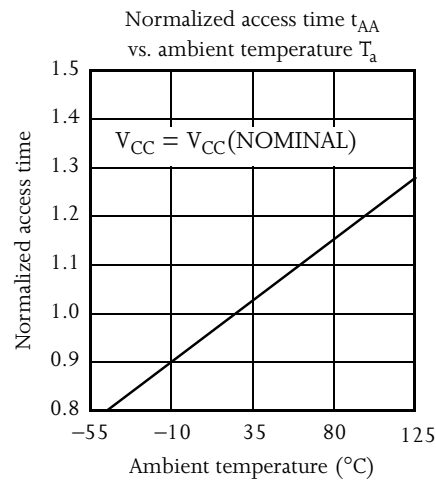
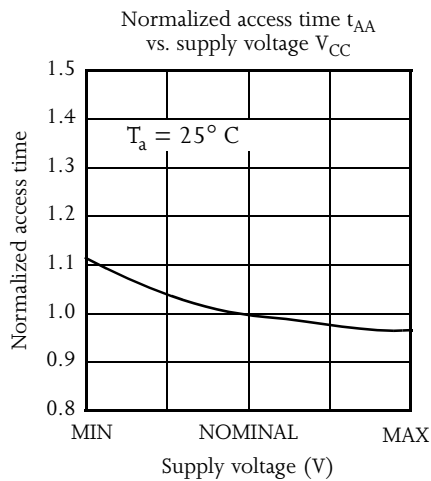
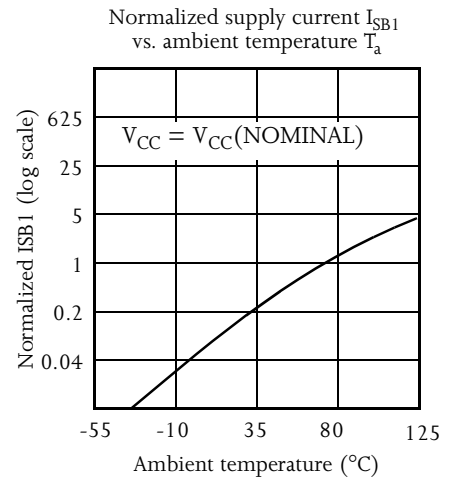
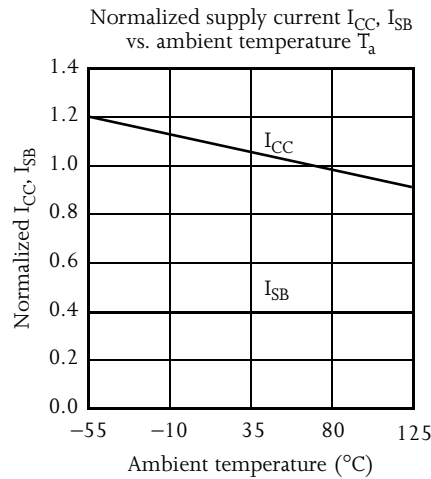
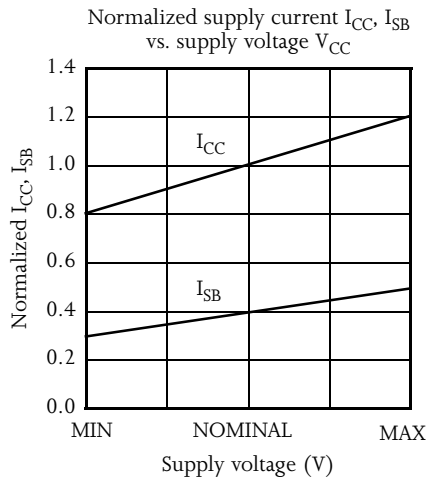



Package dimensions

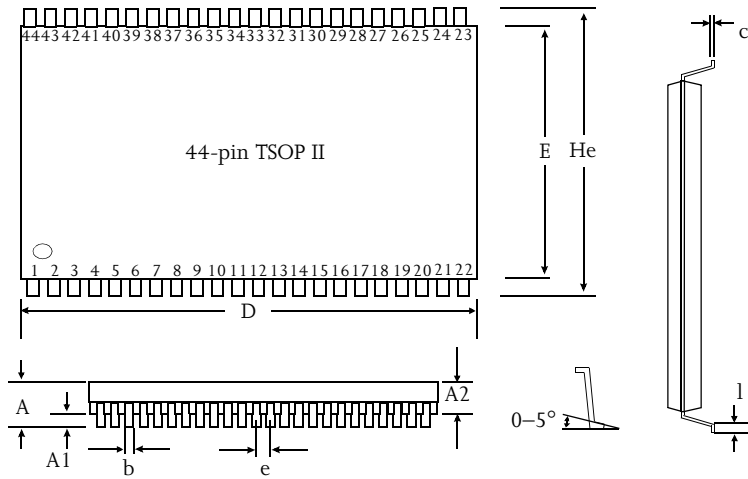

	44-pin TSOP II	
	Min (mm)	Max (mm)
A		1.2
A1	0.05	
A2	0.95	1.05
b	0.30	0.45
c	0.127 (typical)	
D	18.28	18.54
E	10.03	10.29
He	11.56	11.96
e	0.80 (typical)	
l	0.40	0.60

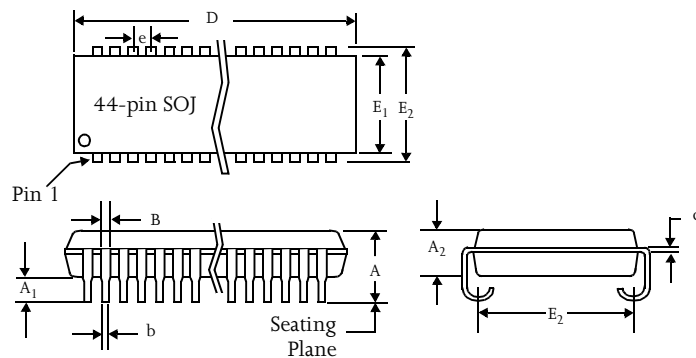

	44-pin SOJ 400 mL	
	Min	Max
A	0.128	0.148
A <sub>1</sub>	0.025	—
A <sub>2</sub>	1.105	1.115
B	0.026	0.032
b	0.015	0.020
c	0.007	0.013
D	1.120	1.130
E	0.370 NOM	
E <sub>1</sub>	0.395	0.405
E <sub>2</sub>	0.435	0.445
e	0.050 NOM	





48-ball FBGA

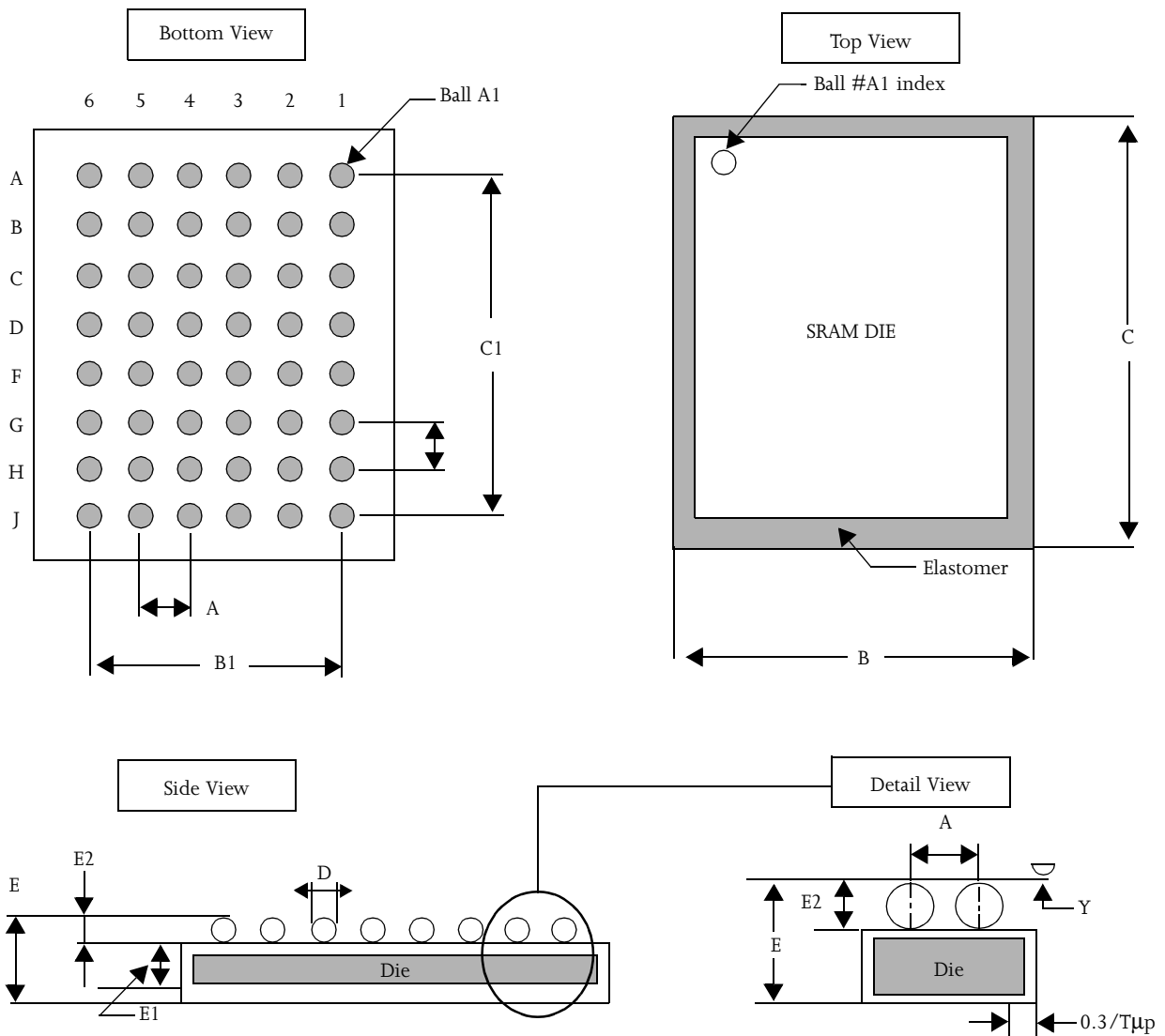

	Minimum	Typical	Maximum
A	—	0.75	—
B	5.90	8.00	8.10
B1	—	3.75	—
C	7.90	8.00	8.10
C1	—	5.25	—
D	—	0.35	—
E	—	—	1.20
E1	—	0.68	—
E2	0.22	0.25	0.27
Y	—	—	0.08

Notes

- 1 Bump counts: 48 (8 row x 6 column).
- 2 Pitch: (x,y) = 0.75 mm x 0.75 mm (typ).
- 3 Units: millimeters.
- 4 All tolerance are +/- 0.050 unless otherwise specified.
- 5 Typ: typical.
- 6 Y is coplanarity: 0.08 (max).



## Ordering codes

Package \ Access time	Volt/Temp	12 ns	15 ns	20 ns
Plastic SOJ, 400 mil	5V commercial	AS7C1026-12JC	AS7C1026-15JC	AS7C1026-20JC
	5V industrial	AS7C1026-12JI	AS7C1026-15JI	AS7C1026-20JI
	3.3V commercial	AS7C31026-12JC	AS7C31026-15JC	AS7C31026-20JC
TSOP II, 18.4×10.2 mm	5V commercial	AS7C1026-12TC	AS7C1026-15TC	AS7C1026-20TC
	3.3V commercial	AS7C31026-12TC	AS7C31026-15TC	AS7C31026-20TC
	3.3V industrial	AS7C31026-12TI	AS7C31026-15TI	AS7C31026-20TI
CSP BGA, 8×6 mm	5V commercial	AS7C1026-12BC	AS7C1026-15BC	AS7C1026-20BC
	3.3V commercial	AS7C31026-12BC	AS7C31026-15BC	AS7C31026-20BC
	3.3V industrial	AS7C31026-12BI	AS7C31026-15BI	AS7C31026-20BI

NA: not available.

Shaded areas indicate preliminary information.

## Part numbering system

AS7C	X	1026	-XX	X	C
SRAM prefix	Blank=5V CMOS 3=3.3V CMOS	Device number	Access time	Package: J=SOJ 400 mil T=TSOP type 2, 18.4 × 10.2 mm B=CSP BGA, 8 × 6 mm	Temperature range, C=Commercial: 0° C to 70° C I=Industrial: -40° C to 85° C