



Hybrid Power Module

Integrated Power Stage for 1.0 hp Motor Drives

This module integrates a 3-phase input rectifier bridge, 3-phase output inverter and brake transistor/diode in a single convenient package. The output inverter utilizes advanced insulated gate bipolar transistors (IGBT) matched with free-wheeling diodes to give optimal dynamic performance. It has been configured for use as a three-phase motor drive module or for many other power switching applications. The top connector pins have been designed for easy interfacing to the user's control board.

- Short Circuit Rated 10 μ s @ 25°C
- Pin-to-Baseplate Isolation exceeds 2500 Vac (rms)
- Convenient Package Outline
- UL  Recognized and Designed to Meet VDE 
- Access to Positive and Negative DC Bus

MHPM7B15A60A

Motorola Preferred Device

**15 AMP, 600 VOLT
HYBRID POWER MODULE**

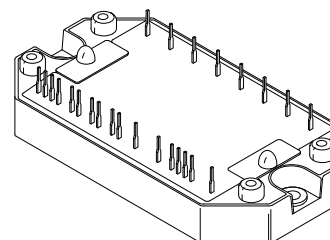

PLASTIC PACKAGE
CASE 440-01, Style 1

MAXIMUM DEVICE RATINGS ($T_J = 25^\circ\text{C}$ unless otherwise noted)

| Rating | Symbol | Value | Unit |
|--|-------------|--------------|------------------|
| INPUT RECTIFIER BRIDGE | | | |
| Repetitive Peak Reverse Voltage | V_{RRM} | 600 | V |
| Average Output Rectified Current | I_O | 15 | A |
| Peak Non-repetitive Surge Current — (1/2 Cycle) (1) | I_{FSM} | 200 | A |
| OUTPUT INVERTER | | | |
| IGBT Reverse Voltage | V_{CES} | 600 | V |
| Gate-Emitter Voltage | V_{GES} | ± 20 | V |
| Continuous IGBT Collector Current | I_C | 15 | A |
| Peak IGBT Collector Current — (PW = 1.0 ms) (2) | $I_{C(pk)}$ | 30 | A |
| Continuous Free-Wheeling Diode Current | I_F | 15 | A |
| Peak Free-Wheeling Diode Current — (PW = 1.0 ms) (2) | $I_{F(pk)}$ | 30 | A |
| IGBT Power Dissipation | P_D | 55 | W |
| Free-Wheeling Diode Power Dissipation | P_D | 30 | W |
| IGBT Junction Temperature Range | T_J | - 40 to +125 | $^\circ\text{C}$ |
| Free-Wheeling Diode Junction Temperature Range | T_J | - 40 to +125 | $^\circ\text{C}$ |

(1) 1 cycle = 50 or 60 Hz

(2) 1.0 ms = 1.0% duty cycle

Preferred devices are Motorola recommended choices for future use and best overall value.

MAXIMUM DEVICE RATINGS (continued) ($T_J = 25^\circ\text{C}$ unless otherwise noted)

| Rating | Symbol | Value | Unit |
|---|-------------|----------|------|
| BRAKE CIRCUIT | | | |
| IGBT Reverse Voltage | V_{CES} | 600 | V |
| Gate-Emitter Voltage | V_{GES} | ± 20 | V |
| Continuous IGBT Collector Current | I_C | 15 | A |
| Peak IGBT Collector Current (PW = 1.0 ms) (2) | $I_{C(pk)}$ | 30 | A |
| IGBT Power Dissipation | PD | 55 | W |
| Diode Reverse Voltage | V_{RRM} | 600 | V |
| Continuous Output Diode Current | I_F | 15 | A |
| Peak Output Diode Current (PW = 1.0 ms) (2) | $I_{F(pk)}$ | 30 | A |

TOTAL MODULE

| | | | |
|---|-----------|--------------|------------------|
| Isolation Voltage — (47–63 Hz, 1.0 Minute Duration) | V_{ISO} | 2500 | VAC |
| Ambient Operating Temperature Range | T_A | - 40 to + 85 | $^\circ\text{C}$ |
| Operating Case Temperature Range | T_C | - 40 to + 90 | $^\circ\text{C}$ |
| Storage Temperature Range | T_{stg} | - 40 to +150 | $^\circ\text{C}$ |
| Mounting Torque | — | 6.0 | lb-in |

ELECTRICAL CHARACTERISTICS ($T_J = 25^\circ\text{C}$ unless otherwise noted)

| Characteristic | Symbol | Min | Typ | Max | Unit |
|--|-----------------|--------|--------|------------|---------------------|
| INPUT RECTIFIER BRIDGE | | | | | |
| Reverse Leakage Current ($V_{RRM} = 600\text{ V}$) | I_R | — | 10 | 50 | μA |
| Forward Voltage ($I_F = 15\text{ A}$) | V_F | — | 1.05 | 1.5 | V |
| Thermal Resistance (Each Die) | $R_{\theta JC}$ | — | — | 2.9 | $^\circ\text{C/W}$ |
| OUTPUT INVERTER | | | | | |
| Gate-Emitter Leakage Current ($V_{CE} = 0\text{ V}$, $V_{GE} = \pm 20\text{ V}$) | I_{GES} | — | — | ± 20 | μA |
| Collector-Emitter Leakage Current ($V_{CE} = 600\text{ V}$, $V_{GE} = 0\text{ V}$) $T_J = 25^\circ\text{C}$ $T_J = 125^\circ\text{C}$ | I_{CES} | — — | — — | 200 2.0 | μA mA |
| Gate-Emitter Threshold Voltage ($V_{CE} = V_{GE}$, $I_C = 1.0\text{ mA}$) | $V_{GE(th)}$ | 4.0 | 6.0 | 8.0 | V |
| Collector-Emitter Breakdown Voltage ($I_C = 10\text{ mA}$, $V_{GE} = 0$) | $V_{(BR)CES}$ | 600 | 700 | — | V |
| Collector-Emitter Saturation Voltage ($V_{GE} = 15\text{ V}$, $I_C = 15\text{ A}$) | $V_{CE(SAT)}$ | — | 2.7 | 3.5 | V |
| Input Capacitance ($V_{GE} = 0\text{ V}$, $V_{CE} = 10\text{ V}$, $f = 1.0\text{ MHz}$) | C_{ies} | — | 950 | — | pF |
| Input Gate Charge ($V_{CE} = 300\text{ V}$, $I_C = 15\text{ A}$, $V_{GE} = 15\text{ V}$) | Q_T | — | 75 | — | nC |
| Fall Time — Inductive Load ($V_{CE} = 300\text{ V}$, $I_C = 15\text{ A}$, $V_{GE} = 15\text{ V}$, $R_G = 150\ \Omega$) | t_{fi} | — | 200 | 350 | ns |
| Turn-On Energy ($V_{CE} = 300\text{ V}$, $I_C = 15\text{ A}$, $V_{GE} = 15\text{ V}$, $R_G = 150\ \Omega$) | $E_{(on)}$ | — | — | 1.0 | mJ |
| Turn-Off Energy ($V_{CE} = 300\text{ V}$, $I_C = 15\text{ A}$, $V_{GE} = 15\text{ V}$, $R_G = 150\ \Omega$) | $E_{(off)}$ | — | — | 1.0 | mJ |
| Diode Forward Voltage ($I_F = 15\text{ A}$, $V_{GE} = 0\text{ V}$) | V_F | — | 1.5 | 2.0 | V |
| Diode Reverse Recovery Time ($I_F = 15\text{ A}$, $V = 400\text{ V}$, $di/dt = 50\text{ A}/\mu\text{s}$) | t_{rr} | — | 140 | 200 | ns |
| Diode Stored Charge ($I_F = 15\text{ A}$, $V = 400\text{ V}$, $di/dt = 50\text{ A}/\mu\text{s}$) | Q_{rr} | — | — | 900 | nC |
| Thermal Resistance — IGBT (Each Die) | $R_{\theta JC}$ | — | — | 1.9 | $^\circ\text{C/W}$ |
| Thermal Resistance — Free-Wheeling Diode (Each Die) | $R_{\theta JC}$ | — | — | 3.7 | $^\circ\text{C/W}$ |

(2) 1.0 ms = 1.0% duty cycle

ELECTRICAL CHARACTERISTICS (continued) ($T_J = 25^\circ\text{C}$ unless otherwise noted)

| Characteristic | Symbol | Min | Typ | Max | Unit |
|--|-----------------|--------|--------|------------|------------------------------|
| BRAKE CIRCUIT | | | | | |
| Gate-Emitter Leakage Current ($V_{CE} = 0\text{ V}$, $V_{GE} = \pm 20\text{ V}$) | I_{GES} | — | — | ± 20 | μA |
| Collector-Emitter Leakage Current ($V_{CE} = 600\text{ V}$, $V_{GE} = 0\text{ V}$) (1) $T_J = 25^\circ\text{C}$ $T_J = 125^\circ\text{C}$ | I_{CES} | — — | — — | 200 2.0 | μA mA |
| Gate-Emitter Threshold Voltage ($V_{CE} = V_{GE}$, $I_C = 1.0\text{ mA}$) | $V_{GE(th)}$ | 4.0 | 6.0 | 8.0 | V |
| Collector-Emitter Breakdown Voltage ($I_C = 10\text{ mA}$, $V_{GE} = 0$) | $V_{(BR)CES}$ | 600 | 700 | — | V |
| Collector-Emitter Saturation Voltage ($V_{GE} = 15\text{ V}$, $I_C = 15\text{ A}$) (1) | $V_{CE(SAT)}$ | — | 2.7 | 3.5 | V |
| Input Capacitance ($V_{GE} = 0\text{ V}$, $V_{CE} = 10\text{ V}$, $f = 1.0\text{ MHz}$) | C_{ies} | — | 950 | — | pF |
| Input Gate Charge ($V_{CE} = 300\text{ V}$, $I_C = 15\text{ A}$, $V_{GE} = 15\text{ V}$) | Q_T | — | 75 | — | nC |
| Fall Time — Inductive Load ($V_{CE} = 300\text{ V}$, $I_C = 15\text{ A}$, $V_{GE} = 15\text{ V}$, $R_G = 150\ \Omega$) | t_{fi} | — | 200 | 350 | ns |
| Turn-On Energy ($V_{CE} = 300\text{ V}$, $I_C = 15\text{ A}$, $V_{GE} = 15\text{ V}$, $R_G = 150\ \Omega$) | $E_{(on)}$ | — | — | 1.0 | mJ |
| Turn-Off Energy ($V_{CE} = 300\text{ V}$, $I_C = 15\text{ A}$, $V_{GE} = 15\text{ V}$, $R_G = 150\ \Omega$) | $E_{(off)}$ | — | — | 1.0 | mJ |
| Diode Forward Voltage ($I_F = 15\text{ A}$) | V_F | — | 1.5 | 2.0 | V |
| Diode Reverse Leakage Current | I_R | — | — | 50 | μA |
| Thermal Resistance — IGBT | $R_{\theta JC}$ | — | — | 1.9 | $^\circ\text{C/W}$ |
| Thermal Resistance — Diode | $R_{\theta JC}$ | — | — | 3.7 | $^\circ\text{C/W}$ |

(1) 1 cycle = 50 or 60 Hz.

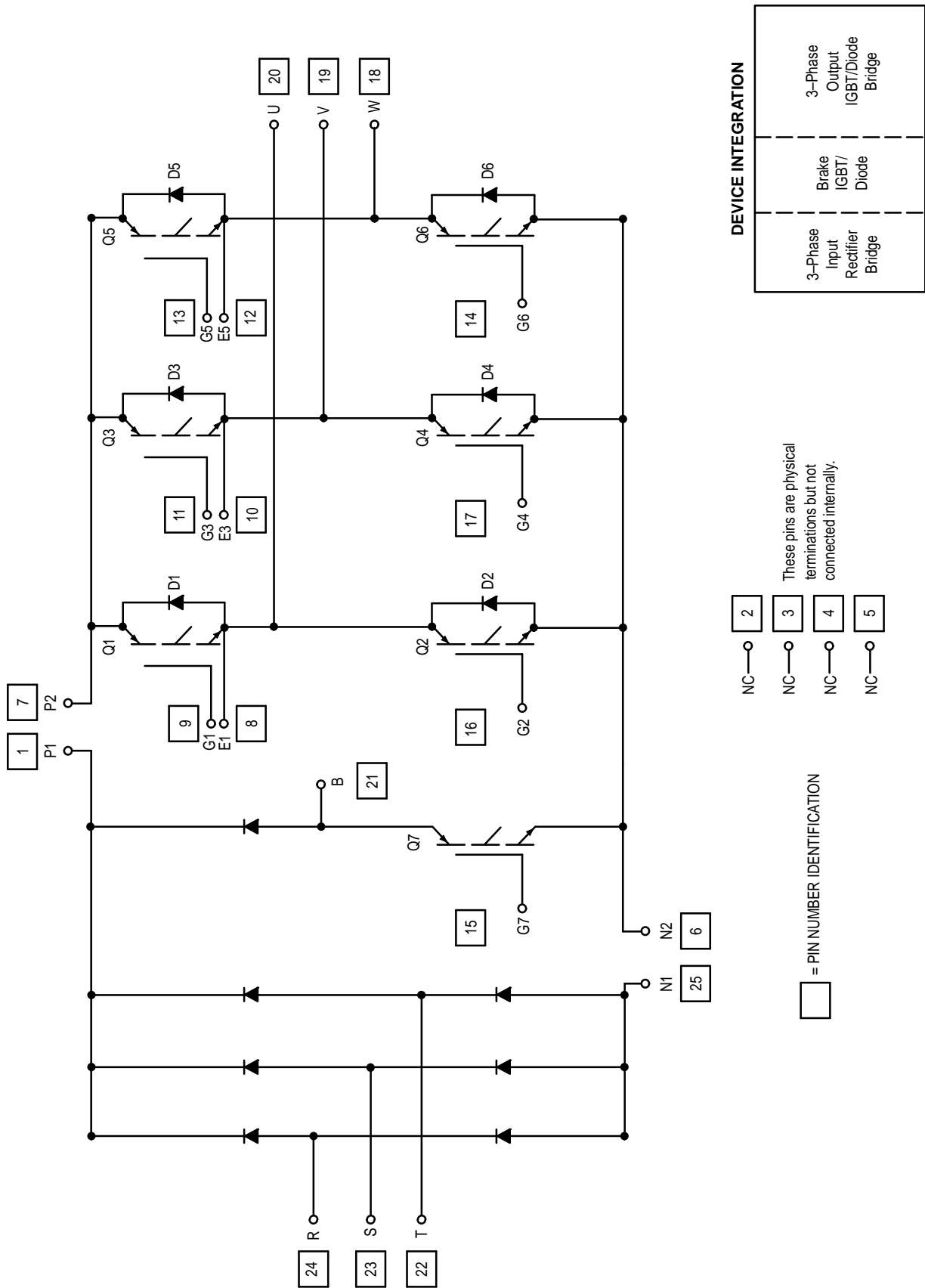

Figure 1. Integrated Power Stage Schematic

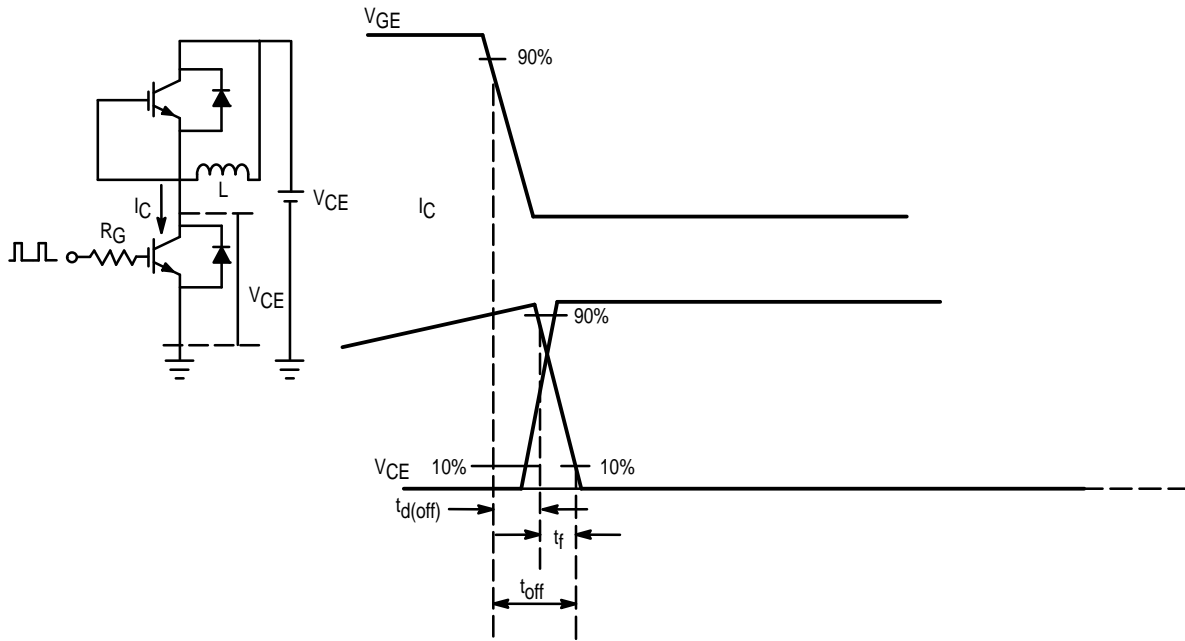

Figure 2. Inductive Switching Time Test Circuit and Timing Chart

Typical Characteristics

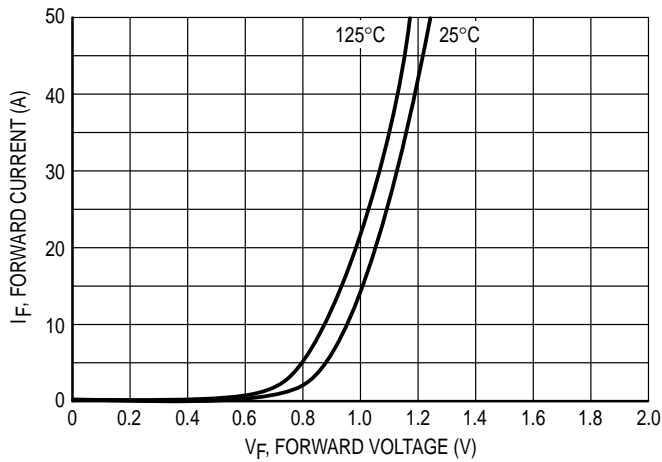

Figure 3. Input Bridge Forward Current versus Forward Voltage

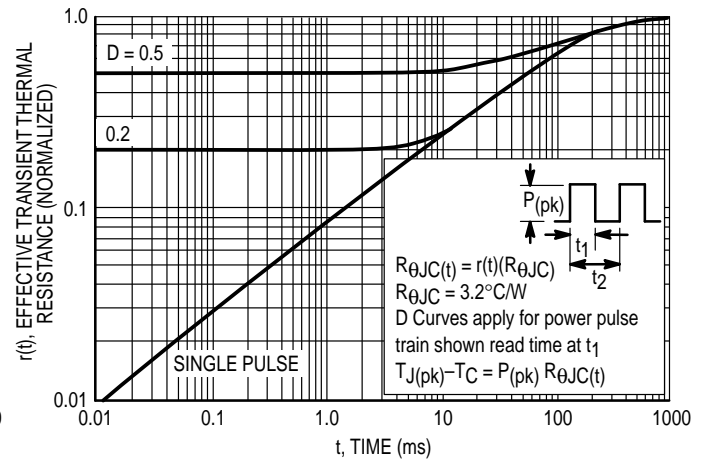

Figure 4. Input Rectifier Bridge Thermal Response

Typical Characteristics

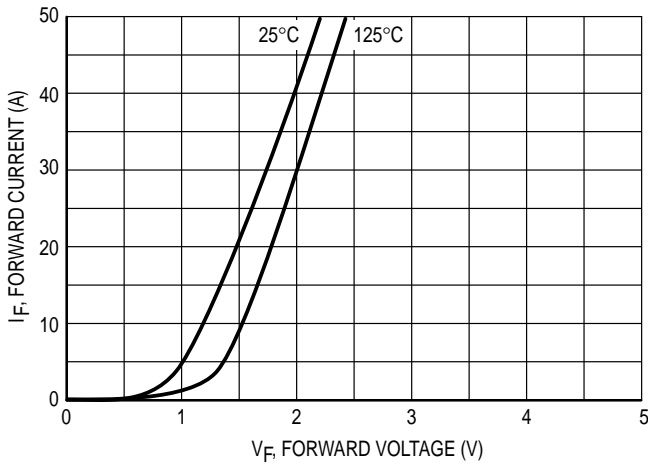

Figure 5. Output Inverter Diode Forward Current versus Forward Voltage

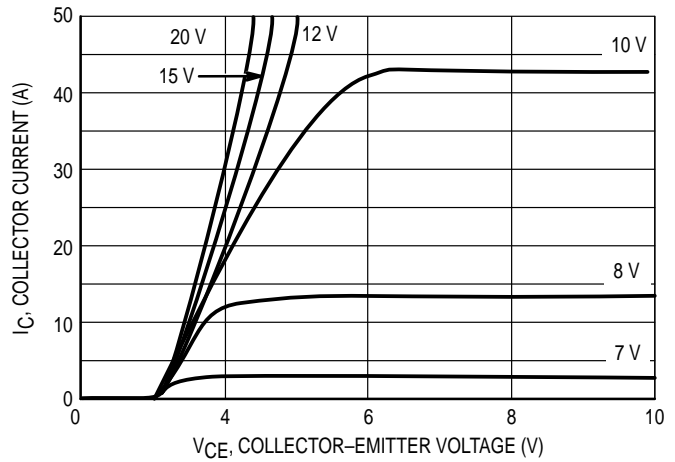

Figure 6. Output Inverter Collector-Current versus Collector-Emitter Voltage

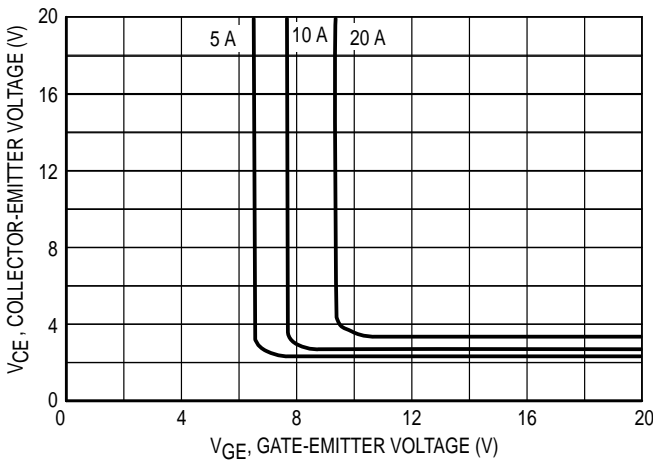

Figure 7. Output Inverter Collector-Emitter Voltage versus Gate-Emitter Voltage

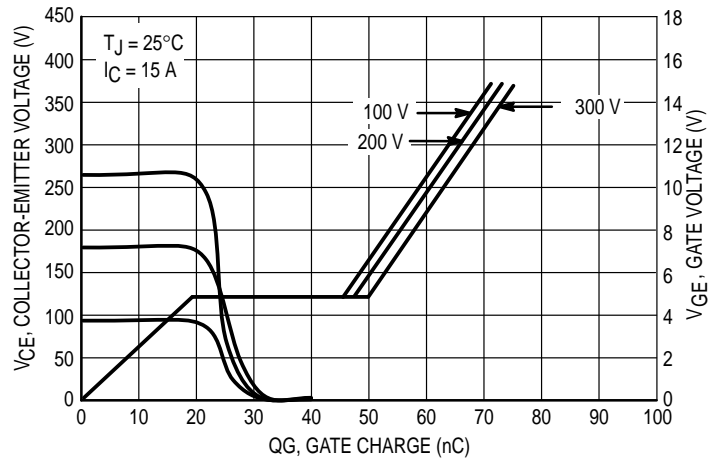

Figure 8. Gate-to-Emitter Voltage versus Gate Charge

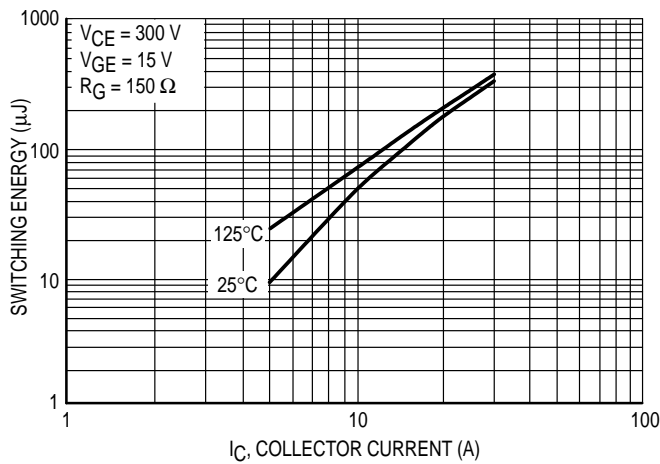

Figure 9. Inverter Switching Energy $E_{(off)}$ versus Collector Current I_C

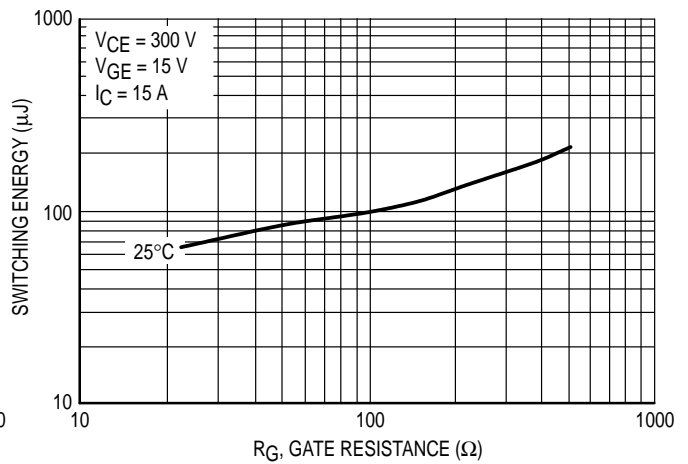

Figure 10. Inverter Switching Energy $E_{(off)}$ versus Gate Resistance R_G

Typical Characteristics

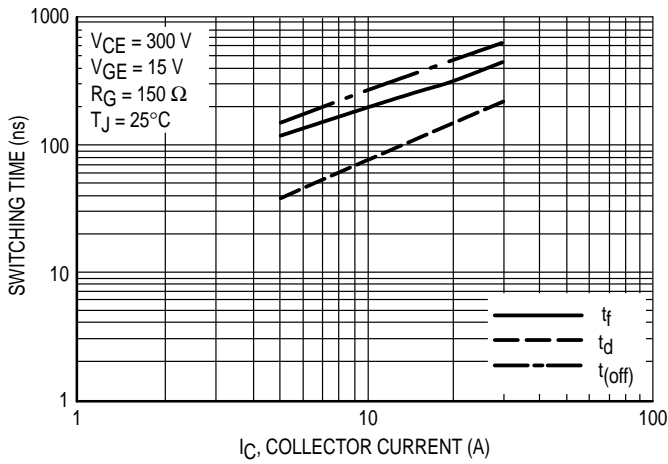

Figure 11. Inverter Switching Time t_f , t_d , $t_{(off)}$ versus Collector Current I_C

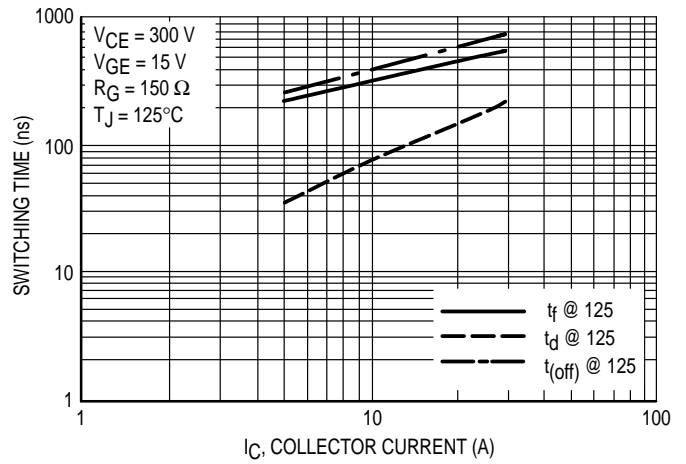

Figure 12. Inverter Switching Time t_f , t_d , $t_{(off)}$ versus Collector Current I_C

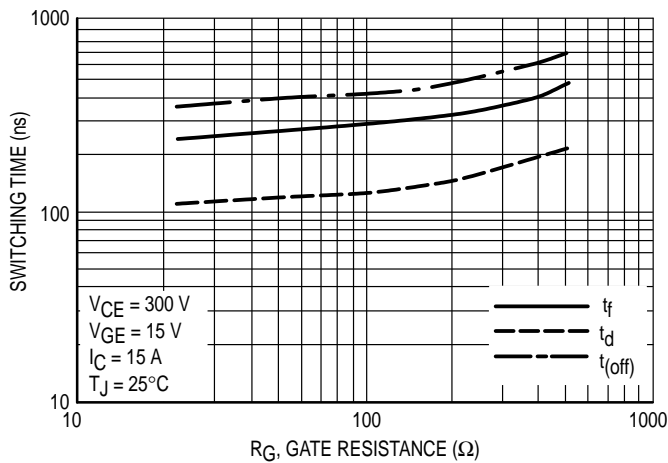

Figure 13. Inverter Switching Time t_f , t_d , $t_{(off)}$ versus Gate Resistance R_G

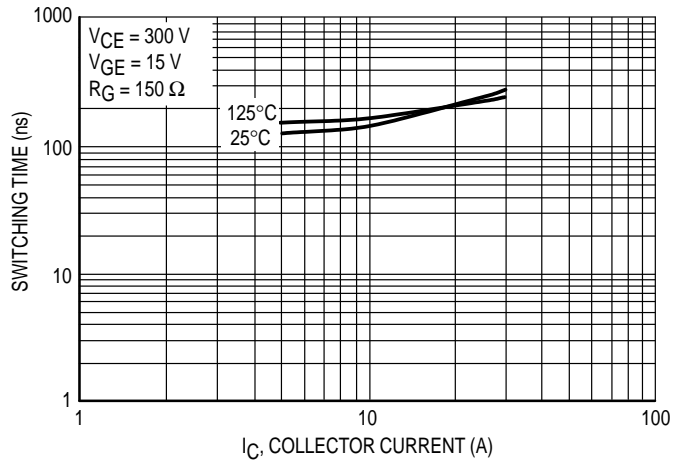

Figure 14. Inverter Switching Time t_f versus Collector Current I_C

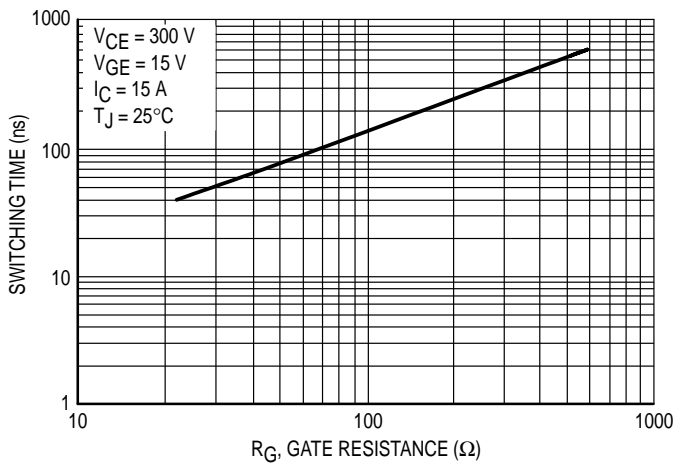

Figure 15. Inverter Switching Time t_f versus Gate Resistance R_G

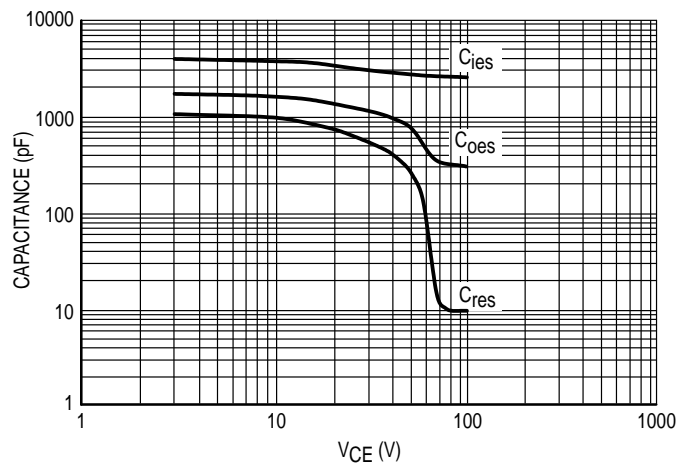

Figure 16. Inverter Capacitance versus V_{CE}

Typical Characteristics

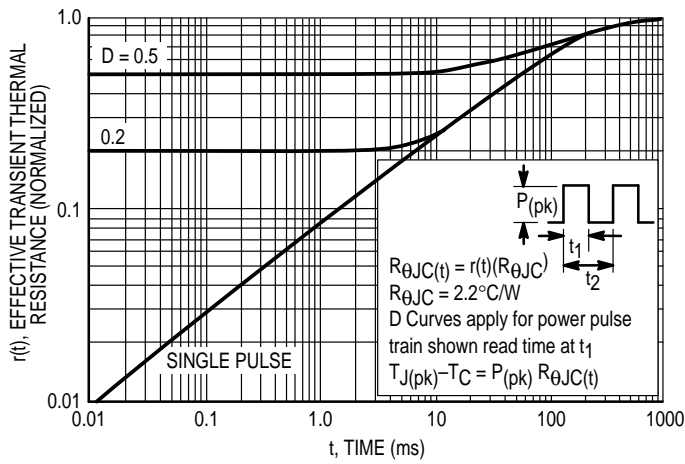

Figure 17. Output Inverter IGBT Thermal Response

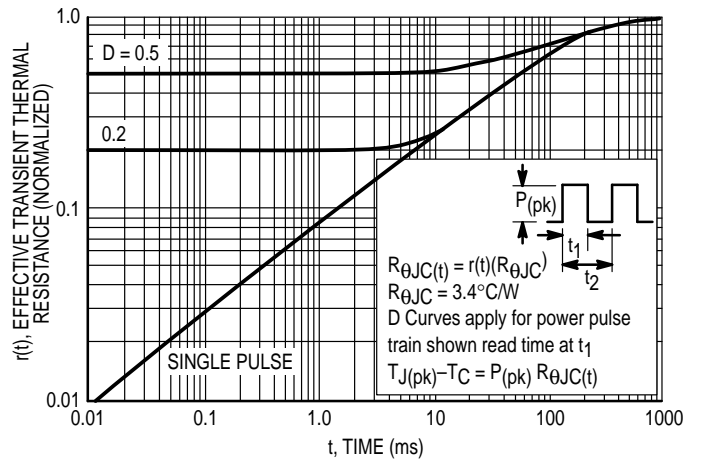

Figure 18. Output Diode Thermal Response

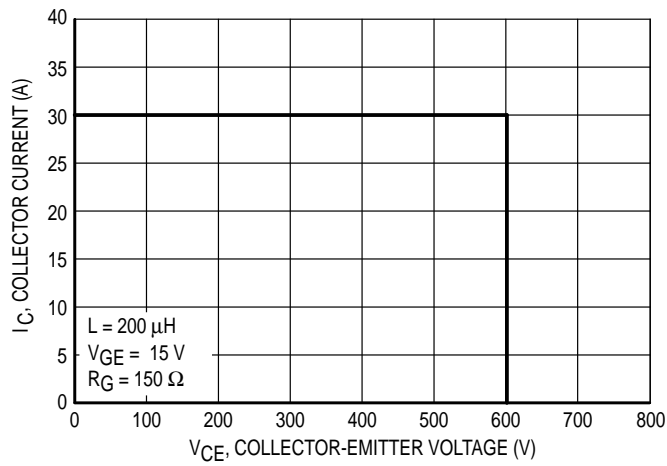
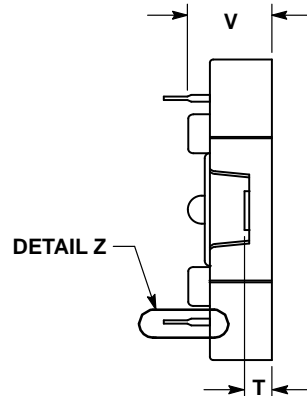
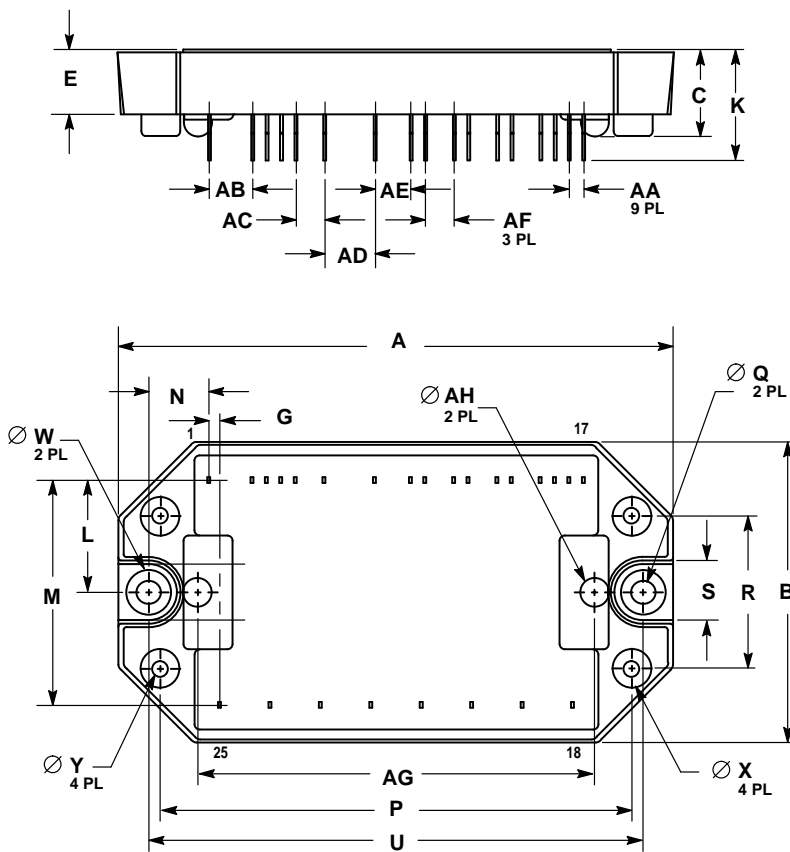

Figure 19. Output Inverter Reverse Bias Safe Operating Area (RBSOA)

PACKAGE DIMENSIONS



- NOTES:
1. DIMENSIONING AND TOLERANCING PER ANSI Y14.5M, 1982.
 2. CONTROLLING DIMENSION: MILLIMETER.
 3. LEAD LOCATION DIMENSIONS (ie: M, B, AA...) ARE TO THE CENTER OF THE LEAD.

| DIM | MILLIMETERS | | INCHES | |
|-----|-------------|-------|--------|-------|
| | MIN | MAX | MIN | MAX |
| A | 97.54 | 98.55 | 3.840 | 3.880 |
| B | 52.45 | 53.47 | 2.065 | 2.105 |
| C | 14.60 | 15.88 | 0.575 | 0.625 |
| D | 0.43 | 0.84 | 0.017 | 0.033 |
| E | 10.80 | 12.06 | 0.425 | 0.475 |
| F | 0.94 | 1.35 | 0.037 | 0.053 |
| G | 1.60 | 2.21 | 0.063 | 0.087 |
| H | 8.58 | 9.19 | 0.338 | 0.362 |
| J | 0.30 | 0.71 | 0.012 | 0.028 |
| K | 18.80 | 20.57 | 0.74 | 0.81 |
| L | 19.30 | 20.32 | 0.760 | 0.800 |
| M | 38.99 | 40.26 | 1.535 | 1.585 |
| N | 9.78 | 11.05 | 0.385 | 0.435 |
| P | 82.55 | 83.57 | 3.250 | 3.290 |
| Q | 4.01 | 4.62 | 0.158 | 0.182 |
| R | 26.42 | 27.43 | 1.040 | 1.080 |
| S | 12.06 | 12.95 | 0.475 | 0.515 |
| T | 4.32 | 5.33 | 0.170 | 0.210 |
| U | 86.36 | 87.38 | 3.400 | 3.440 |
| V | 14.22 | 15.24 | 0.560 | 0.600 |
| W | 7.62 | 8.13 | 0.300 | 0.320 |
| X | 6.55 | 7.16 | 0.258 | 0.282 |
| Y | 2.49 | 3.10 | 0.098 | 0.122 |
| AA | 2.24 | 2.84 | 0.088 | 0.112 |
| AB | 7.32 | 7.92 | 0.288 | 0.312 |
| AC | 4.78 | 5.38 | 0.188 | 0.212 |
| AD | 8.58 | 9.19 | 0.338 | 0.362 |
| AE | 6.05 | 6.65 | 0.238 | 0.262 |
| AF | 4.78 | 5.38 | 0.188 | 0.212 |
| AG | 69.34 | 70.36 | 2.730 | 2.770 |
| AH | — | 5.08 | — | 0.200 |

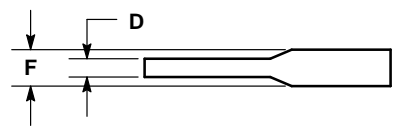
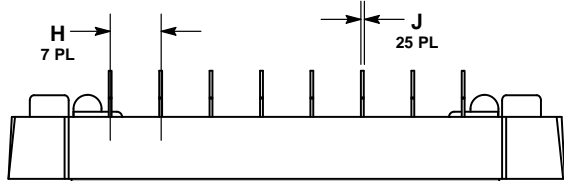

DETAIL Z

- STYLE 1:
- | | | | | |
|-----------|-----------|------------|------------|-----------|
| PIN 1. P1 | PIN 6. N2 | PIN 11. G3 | PIN 16. G2 | PIN 21. B |
| 2. T- | 7. P2 | 12. K5 | 17. G4 | 22. T |
| 3. T+ | 8. K1 | 13. G5 | 18. W | 23. S |
| 4. I+ | 9. G1 | 14. G6 | 19. V | 24. R |
| 5. I- | 10. K3 | 15. G7 | 20. U | 25. N1 |

CASE 440-01
ISSUE 0

Motorola reserves the right to make changes without further notice to any products herein. Motorola makes no warranty, representation or guarantee regarding the suitability of its products for any particular purpose, nor does Motorola assume any liability arising out of the application or use of any product or circuit, and specifically disclaims any and all liability, including without limitation consequential or incidental damages. "Typical" parameters can and do vary in different applications. All operating parameters, including "Typicals" must be validated for each customer application by customer's technical experts. Motorola does not convey any license under its patent rights nor the rights of others. Motorola products are not designed, intended, or authorized for use as components in systems intended for surgical implant into the body, or other applications intended to support or sustain life, or for any other application in which the failure of the Motorola product could create a situation where personal injury or death may occur. Should Buyer purchase or use Motorola products for any such unintended or unauthorized application, Buyer shall indemnify and hold Motorola and its officers, employees, subsidiaries, affiliates, and distributors harmless against all claims, costs, damages, and expenses, and reasonable attorney fees arising out of, directly or indirectly, any claim of personal injury or death associated with such unintended or unauthorized use, even if such claim alleges that Motorola was negligent regarding the design or manufacture of the part. Motorola and  are registered trademarks of Motorola, Inc. Motorola, Inc. is an Equal Opportunity/Affirmative Action Employer.

How to reach us:

USA/EUROPE: Motorola Literature Distribution;
P.O. Box 20912; Phoenix, Arizona 85036. 1-800-441-2447

JAPAN: Nippon Motorola Ltd.; Tatsumi-SPD-JLDC, Toshikatsu Otsuki,
6F Seibu-Butsuryu-Center, 3-14-2 Tatsumi Koto-Ku, Tokyo 135, Japan. 03-3521-8315

MFAX: RMFAX0@email.sps.mot.com -TOUCHTONE (602) 244-6609
INTERNET: <http://Design-NET.com>

HONG KONG: Motorola Semiconductors H.K. Ltd.; 8B Tai Ping Industrial Park,
51 Tinq Kok Road, Tai Po, N.T., Hong Kong. 852-26629298



MOTOROLA

◇ CODELINE TO BE PLACED HERE

MHPM7B15A60A/D

