

General purpose transistor (50V, 0.15A)

2SC2412K / 2SC4081 / 2SC4617 / 2SC5658 / 2SC1740S

●Features

- Low Cob.
Cob=2.0pF (Typ.)
- Complements the 2SA1037AK /
2SA1576A / 2SA1774H /
2SA2029 / 2SA933AS.

●Structure

Epitaxial planar type
NPN silicon transistor

●External dimensions (Units : mm)

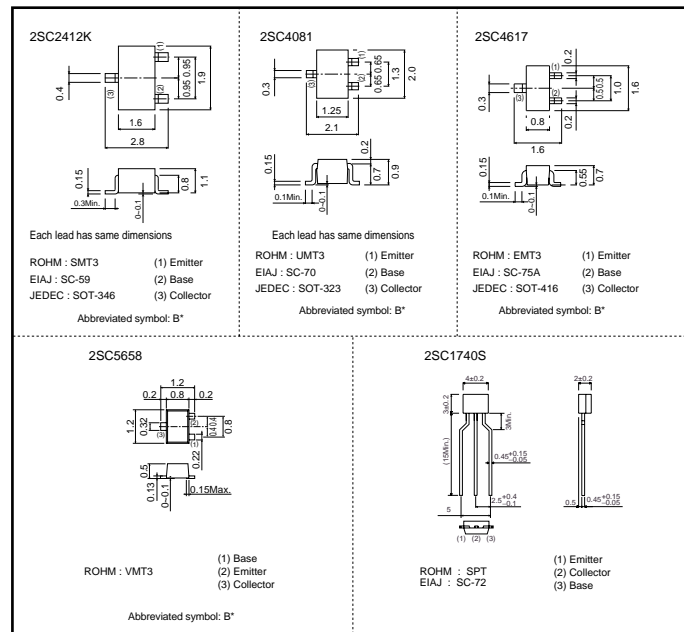

* Denotes hrfc

●Absolute maximum (Ta=25°C)

Parameter	Symbol	Limits	Unit
Collector-base voltage	V _{CB0}	60	V
Collector-emitter voltage	V _{CE0}	50	V
Emitter-base voltage	V _{EB0}	7	V
Collector current	I _c	0.15	A
Collector power dissipation	2SC2412K, 2SC4081	0.2	W
	2SC4617, 2SC5658	0.15	
	2SC1740S	0.3	
Junction temperature	T _j	150	°C
Storage temperature	T _{stg}	-55~+150	°C

2SC2412K / 2SC4081 / 2SC4617 / 2SC5658 / 2SC1740S

Transistors

●Electrical characteristics (Ta=25°C)

Parameter	Symbol	Min.	Typ.	Max.	Unit	Conditions
Collector-base breakdown voltage	BV _{CB0}	60	–	–	V	I _c =50μA
Collector-emitter breakdown voltage	BV _{CEO}	50	–	–	V	I _c =1mA
Emitter-base breakdown voltage	BV _{EB0}	7	–	–	V	I _E =50μA
Collector cutoff current	I _{cBO}	–	–	0.1	μA	V _{CB} =60V
Emitter cutoff current	I _{EBO}	–	–	0.1	μA	V _{EB} =7V
DC current transfer ratio	h _{FE}	120	–	560	–	V _{CE} =6V, I _c =1mA
Collector-emitter saturation voltage	V _{CE(sat)}	–	–	0.4	V	I _c /I _B =50mA/5mA
Transition frequency	f _r	–	180	–	MHz	V _{CE} =12V, I _E =–2mA, f=100MHz
Output capacitance	C _{ob}	–	2	3.5	pF	V _{CE} =12V, I _E =0A, f=1MHz

●Packaging specifications and h_{FE}

Type	h _{FE}	Package	Taping				Bulk
		Code	T146	T106	TL	T2L	TP
		Basic ordering unit (pieces)	3000	3000	3000	8000	5000
2SC2412K	QRS	○	–	–	–	–	
2SC4081	QRS	–	○	–	–	–	
2SC4617	QRS	–	–	○	–	–	
2SC5658	QRS	–	–	–	○	–	
2SC1740S	QRS	–	–	–	–	○	

h_{FE} values are classified as follows :

Item	Q	R	S
h _{FE}	120~270	180~390	270~560

●Electrical characteristic curves

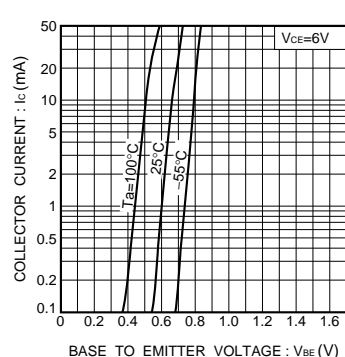

Fig.1 Grounded emitter propagation characteristics

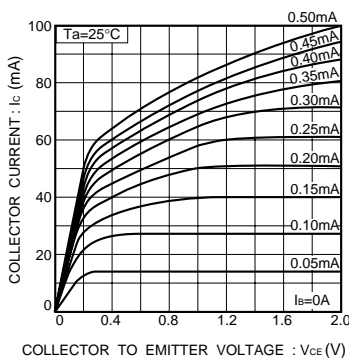

Fig.2 Grounded emitter output characteristics (I)

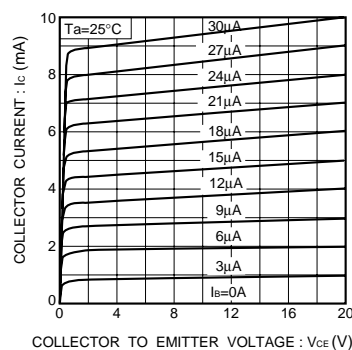

Fig.3 Grounded emitter output characteristics (II)

ROHM

Transistors

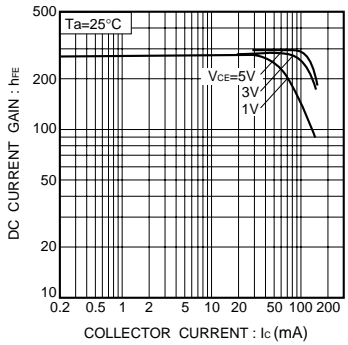

Fig.4 DC current gain vs. collector current (I)

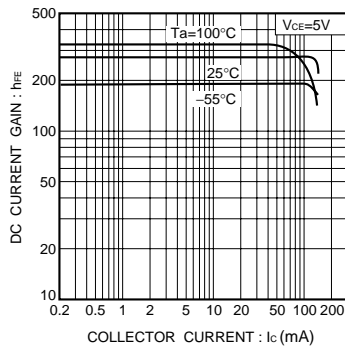

Fig.5 DC current gain vs. collector current (II)

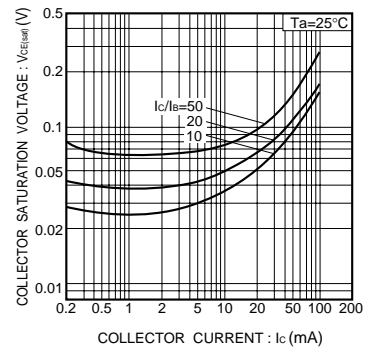

Fig. 6 Collector-emitter saturation voltage vs. collector current

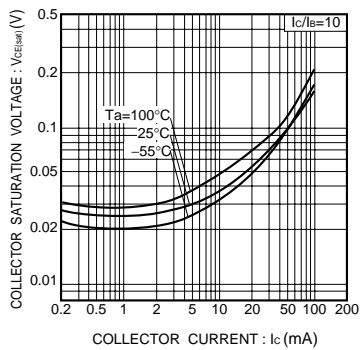

Fig.7 Collector-emitter saturation voltage vs. collector current (I)

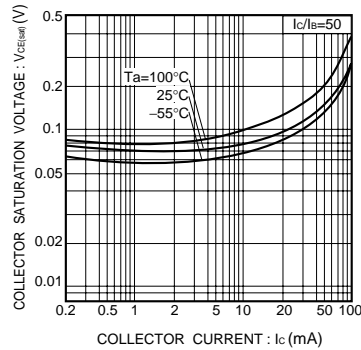

Fig.8 Collector-emitter saturation voltage vs. collector current (II)

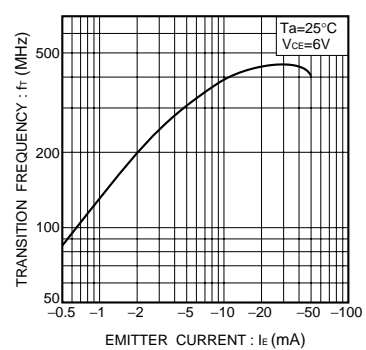

Fig.9 Gain bandwidth product vs. emitter current

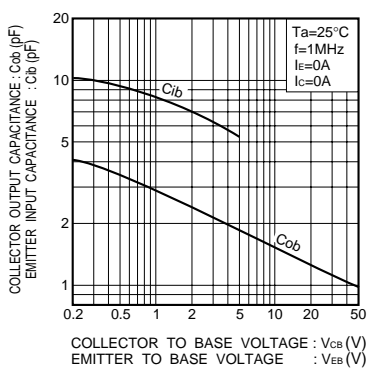

Fig.10 Collector output capacitance vs. collector-base voltage
Emitter input capacitance vs. emitter-base voltage

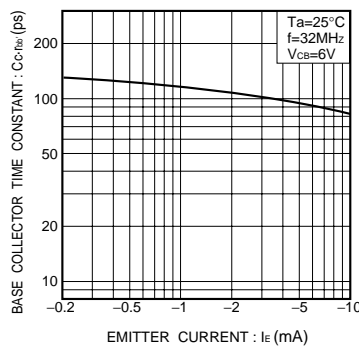

Fig.11 Base-collector time constant vs. emitter current