

FEATURES

Enhanced Replacement for LF411 and TL081

AC PERFORMANCE

Settles to $\pm 0.01\%$ in 1.0 μs

16 V/ μs min Slew Rate (AD711J)

3 MHz min Unity Gain Bandwidth (AD711J)

DC PERFORMANCE

0.25 mV max Offset Voltage: (AD711C)

3 $\mu\text{V}/^\circ\text{C}$ max Drift: (AD711C)

200 V/mV min Open-Loop Gain (AD711K)

4 μV p-p max Noise, 0.1 Hz to 10 Hz (AD711C)

Available in Plastic Mini-DIP, Plastic SO, Hermetic Cerdip, and Hermetic Metal Can Packages

MIL-STD-883B Parts Available

Available in Tape and Reel in Accordance with

EIA-481A Standard

Surface Mount (SOIC)

Dual Version: AD712

PRODUCT DESCRIPTION

The AD711 is a high speed, precision monolithic operational amplifier offering high performance at very modest prices. Its very low offset voltage and offset voltage drift are the results of advanced laser wafer trimming technology. These performance benefits allow the user to easily upgrade existing designs that use older precision BiFETs and, in many cases, bipolar op amps.

The superior ac and dc performance of this op amp makes it suitable for active filter applications. With a slew rate of 16 V/ μs and a settling time of 1 μs to $\pm 0.01\%$, the AD711 is ideal as a buffer for 12-bit D/A and A/D Converters and as a high-speed integrator. The settling time is unmatched by any similar IC amplifier.

The combination of excellent noise performance and low input current also make the AD711 useful for photo diode preamps. Common-mode rejection of 88 dB and open loop gain of 400 V/mV ensure 12-bit performance even in high-speed unity gain buffer circuits.

The AD711 is pinned out in a standard op amp configuration and is available in seven performance grades. The AD711J and AD711K are rated over the commercial temperature range of 0°C to 70°C . The AD711A, AD711B and AD711C are rated over the industrial temperature range of -40°C to $+85^\circ\text{C}$. The AD711S and AD711T are rated over the military temperature range of -40°C to $+125^\circ\text{C}$ and are available processed to MIL-STD-883B, Rev. C.

REV. B

Information furnished by Analog Devices is believed to be accurate and reliable. However, no responsibility is assumed by Analog Devices for its use, nor for any infringements of patents or other rights of third parties that may result from its use. No license is granted by implication or otherwise under any patent or patent rights of Analog Devices.

CONNECTION DIAGRAMS

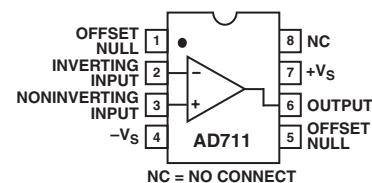
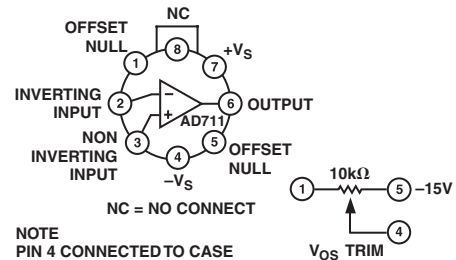

Extended reliability PLUS screening is available, specified over the commercial and industrial temperature ranges. PLUS screening includes 168 hour burn-in, as well as other environmental and physical tests.

The AD711 is available in an 8-pin plastic mini-DIP, small outline, cerdip, TO-99 metal can, or in chip form.

PRODUCT HIGHLIGHTS

1. The AD711 offers excellent overall performance at very competitive prices.
2. Analog Devices' advanced processing technology and 100% testing guarantee a low input offset voltage (0.25 mV max, C grade, 2 mV max, J grade). Input offset voltage is specified in the warmed-up condition. Analog Devices' laser wafer drift trimming process reduces input offset voltage drifts to 3 $\mu\text{V}/^\circ\text{C}$ max on the AD711C.
3. Along with precision dc performance, the AD711 offers excellent dynamic response. It settles to $\pm 0.01\%$ in 1 μs and has a 100% tested minimum slew rate of 16 V/ μs . Thus this device is ideal for applications such as DAC and ADC buffers which require a combination of superior ac and dc performance.
4. The AD711 has a guaranteed and tested maximum voltage noise of 4 μV p-p, 0.1 to 10 Hz (AD711C).
5. Analog Devices' well-matched, ion-implanted JFETs ensure a guaranteed input bias current (at either input) of 25 pA max (AD711C) and an input offset current of 10 pA max (AD711C). Both input bias current and input offset current are guaranteed in the warmed-up condition.

AD711—SPECIFICATIONS ($V_S = \pm 15\text{ V}$ @ $T_A = 25^\circ\text{C}$, unless otherwise noted.)

Parameter	J/A/S			K/B/T			C			Unit
	Min	Typ	Max	Min	Typ	Max	Min	Typ	Max	
INPUT OFFSET VOLTAGE¹										
Initial Offset		0.3	2/1/1		0.2	0.5		0.10	0.25	mV
T_{MIN} to T_{MAX}			3/2/2			1.0			0.45	mV
vs. Temp		7	20/20/20		5	10		2	5	$\mu\text{V}/^\circ\text{C}$
vs. Supply	76	95		80	100		86	110		dB
T_{MIN} to T_{MAX}	76/76/76			80			86			dB
Long-Term Stability		15			15			15		$\mu\text{V}/\text{Month}$
INPUT BIAS CURRENT²										
$V_{\text{CM}} = 0\text{ V}$		15	50		15	50		15	25	pA
$V_{\text{CM}} = 0\text{ V}$ @ T_{MAX}			1.1/3.2/51			1.1/3.2/51			1.6	nA
$V_{\text{CM}} = \pm 10\text{ V}$		20	100		20	100		20	50	pA
INPUT OFFSET CURRENT										
$V_{\text{CM}} = 0\text{ V}$		10	25		5	25		5	10	pA
$V_{\text{CM}} = 0\text{ V}$ @ T_{MAX}			0.6/1.6/26			0.6/1.6/26			0.65	nA
FREQUENCY RESPONSE										
Small Signal Bandwidth	3.0	4.0		3.4	4.0		3.4	4.0		MHz
Full Power Response		200			200			200		kHz
Slew Rate	16	20		18	20		18	20		V/ μs
Settling Time to 0.01%		1.0	1.2		1.0	1.2		1.0	1.2	μs
Total Harmonic Distortion		0.0003			0.0003			0.0003		%
INPUT IMPEDANCE										
Differential		3×10^{12}	5.5		3×10^{12}	5.5		3×10^{12}	5.5	Ω pF
Common Mode		3×10^{12}	5.5		3×10^{12}	5.5		3×10^{12}	5.5	Ω pF
INPUT VOLTAGE RANGE										
Differential ³		± 20			± 20			± 20		V
Common-Mode Voltage ⁴		+14.5, -11.5			+14.5, -11.5			+14.5, -11.5		V
T_{MIN} to T_{MAX}	$-V_S + 4$		$+V_S - 2$	$-V_S + 4$		$+V_S - 2$	$-V_S + 4$		$+V - 2$	V
Common-Mode Rejection Ratio										
$V_{\text{CM}} = \pm 10\text{ V}$	76	88		80	88		86	94		dB
T_{MIN} to T_{MAX}	76/76/76	84		80	84		86	90		dB
$V_{\text{CM}} = \pm 11\text{ V}$	70	84		76	84		76	90		dB
T_{MIN} to T_{MAX}	70/70/70	80		74	80		74	84		dB
INPUT VOLTAGE NOISE										
		2			2			2	4	$\mu\text{V p-p}$
		45			45			45		$\text{nV}/\sqrt{\text{Hz}}$
		22			22			22		$\text{nV}/\sqrt{\text{Hz}}$
		18			18			18		$\text{nV}/\sqrt{\text{Hz}}$
		16			16			16		$\text{nV}/\sqrt{\text{Hz}}$
INPUT CURRENT NOISE		0.01			0.01			0.01		$\text{pA}/\sqrt{\text{Hz}}$
OPEN-LOOP GAIN	150	400		200	400		200	400		V/mV
	100/100/100			100			100			V/mV
OUTPUT CHARACTERISTICS										
Voltage	+13, -12.5	+13.9, -13.3		+13, -12.5	+13.9, -13.3		+13, -12.5	+13.9, -13.3		V
	$\pm 12/\pm 12/\pm 12$	+13.8, -13.1		± 12	+13.8, -13.1		± 12	+13.8, -13.1		V
Current		25			25			25		mA
POWER SUPPLY										
Rated Performance		± 15			± 15			± 15		V
Operating Range	± 4.5		± 18	± 4.5		± 18	± 4.5		± 18	V
Quiescent Current		2.5	3.4		2.5	3.0		2.5	2.8	mA

NOTES

¹Input Offset Voltage specifications are guaranteed after 5 minutes of operation at $T_A = 25^\circ\text{C}$.

²Bias Current specifications are guaranteed maximum at either input after 5 minutes of operation at $T_A = 25^\circ\text{C}$. For higher temperatures, the current doubles every 10°C .

³Defined as voltage between inputs, such that neither exceeds $\pm 10\text{ V}$ from ground.

⁴Typically exceeding -14.1 V negative common-mode voltage on either input results in an output phase reversal.

Specifications subject to change without notice.

ABSOLUTE MAXIMUM RATINGS¹

Supply Voltage	±18 V
Internal Power Dissipation ²	500 mW
Input Voltage ³	±18 V
Output Short Circuit Duration	Indefinite
Differential Input Voltage	+V _S and -V _S
Storage Temperature Range (Q, H)	-65°C to +150°C
Storage Temperature Range (N)	-65°C to +125°C
Operating Temperature Range	
AD711J/K	0°C to +70°C
AD711A/B/C	-40°C to +85°C
AD711S/T	-55°C to +125°C
Lead Temperature Range (Soldering 60 sec)	300°C

NOTES

¹Stresses above those listed under “Absolute Maximum Ratings” may cause permanent damage to the device. This is a stress rating only and functional operation of the device at these or any other conditions above those indicated in the operational section of this specification is not implied. Exposure to absolute maximum rating conditions for extended periods may affect device reliability.

²Thermal Characteristics:

8-Pin Plastic Package: $\theta_{JC} = 33^{\circ}\text{C/Watt}$; $\theta_{JA} = 100^{\circ}\text{C/Watt}$

8-Pin Cerdip Package: $\theta_{JC} = 22^{\circ}\text{C/Watt}$; $\theta_{JA} = 110^{\circ}\text{C/Watt}$

8-Pin Metal Can Package: $\theta_{JC} = 65^{\circ}\text{C/Watt}$; $\theta_{JA} = 150^{\circ}\text{C/Watt}$

³For supply voltages less than ±18 V, the absolute maximum input voltage is equal to the supply voltage.

ORDERING GUIDE

Model	Temperature Range	Package Description	Package Option*
*AD711AH	-40°C to +85°C	8-Pin Metal Can	H-08A
AD711AQ	-40°C to +85°C	8-Pin Ceramic DIP	Q-8
*AD711BQ	-40°C to +85°C	8-Pin Ceramic DIP	Q-8
*AD711CH	-40°C to +85°C	8-Pin Metal Can	H-08A
AD711JN	0°C to 70°C	8-Pin Plastic DIP	N-8
AD711JR	0°C to 70°C	8-Pin Plastic SOIC	R-8
AD711JR-REEL	0°C to 70°C	8-Pin Plastic SOIC	R-8
AD711JR-REEL7	0°C to 70°C	8-Pin Plastic SOIC	R-8
AD711KN	0°C to 70°C	8-Pin Plastic DIP	N-8
AD711KR	0°C to 70°C	8-Pin Plastic SOIC	R-8
AD711KR-REEL	0°C to 70°C	8-Pin Plastic SOIC	R-8
AD711KR-REEL7	0°C to 70°C	8-Pin Plastic SOIC	R-8
*AD711SQ/883B	-55°C to +125°C	8-Pin Ceramic DIP	Q-8
*AD711TQ/883B	-55°C to +125°C	8-Pin Ceramic DIP	Q-8

*Not for new design, obsolete April 2002

CAUTION

ESD (electrostatic discharge) sensitive device. Electrostatic charges as high as 4000 V readily accumulate on the human body and test equipment and can discharge without detection. Although the AD711 features proprietary ESD protection circuitry, permanent damage may occur on devices subjected to high-energy electrostatic discharges. Therefore, proper ESD precautions are recommended to avoid performance degradation or loss of functionality.



AD711—Typical Performance Characteristics

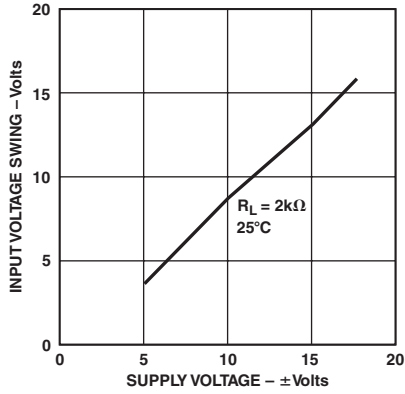

TPC 1. Input Voltage Swing vs. Supply Voltage

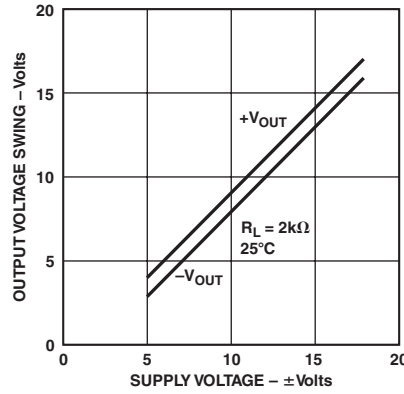

TPC 2. Output Voltage Swing vs. Supply Voltage

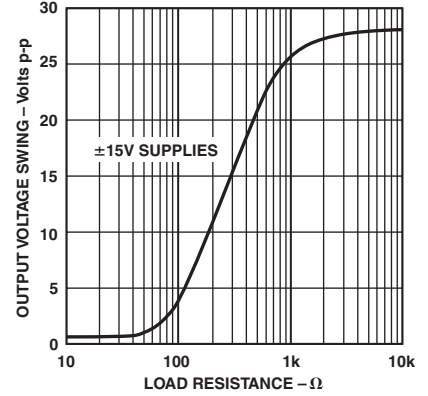

TPC 3. Output Voltage Swing vs. Load Resistance

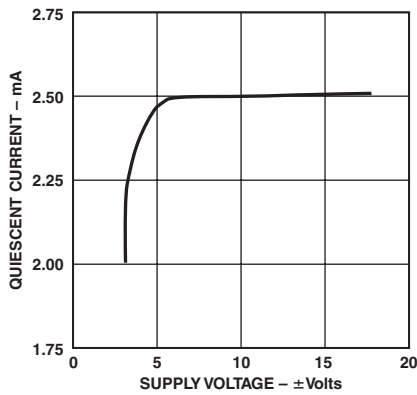

TPC 4. Quiescent Current vs. Supply Voltage

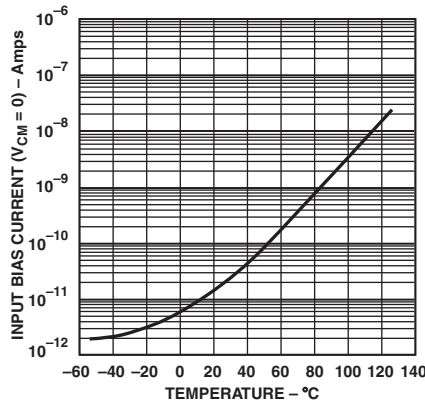

TPC 5. Input Bias Current vs. Temperature

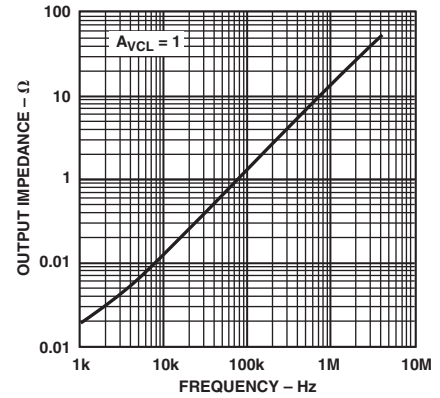

TPC 6. Output Impedance vs. Frequency

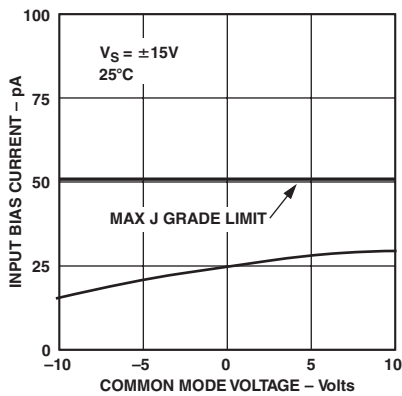

TPC 7. Input Bias Current vs. Common Mode Voltage

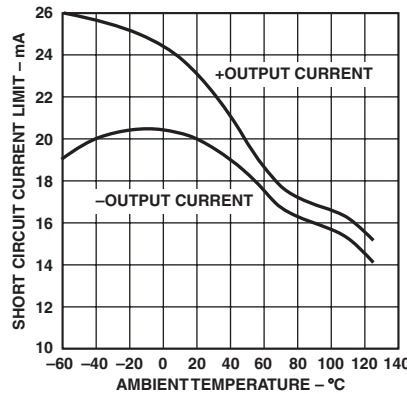

TPC 8. Short Circuit Current Limit vs. Temperature

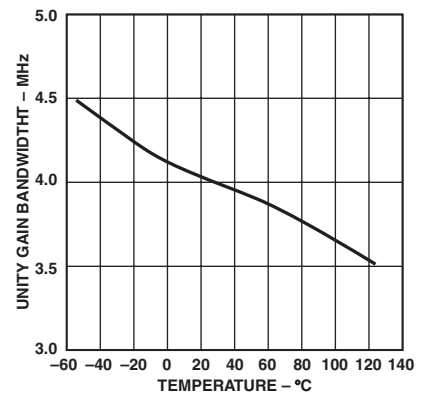

TPC 9. Unity Gain Bandwidth vs. Temperature

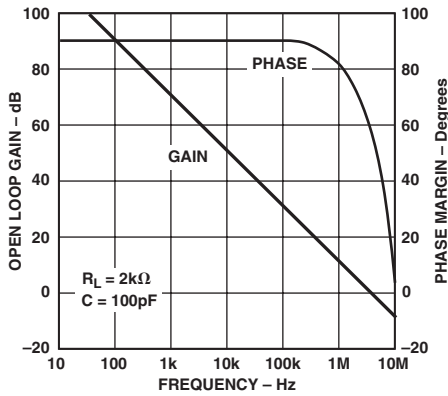

TPC 10. Open-Loop Gain and Phase Margin vs. Frequency

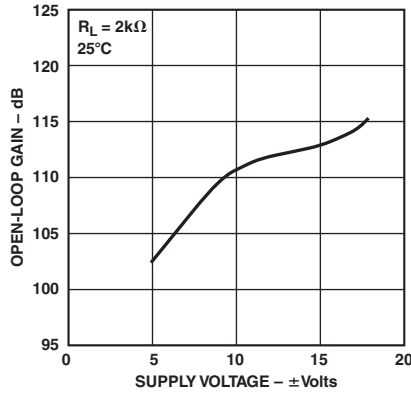

TPC 11. Open-Loop Gain vs. Supply Voltage

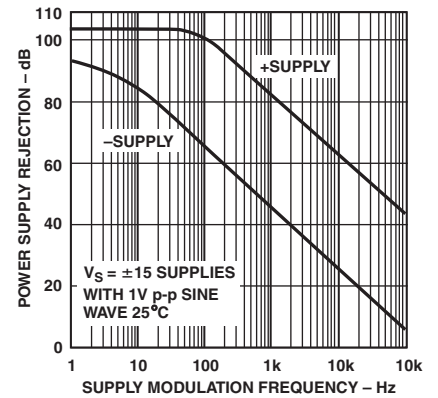

TPC 12. Power Supply Rejection vs. Frequency

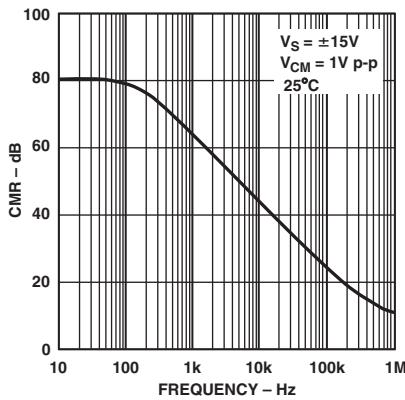

TPC 13. Common Mode Rejection vs. Frequency

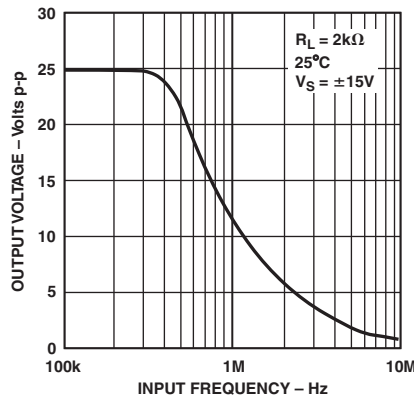

TPC 14. Large Signal Frequency Response

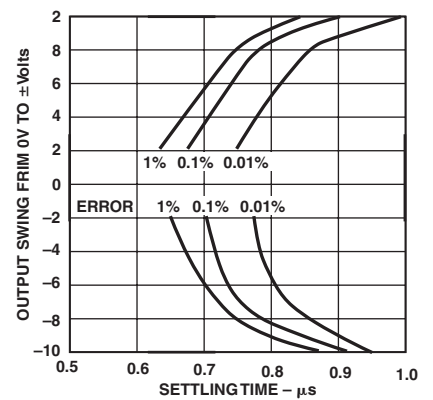

TPC 15. Output Swing and Error vs. Settling Time

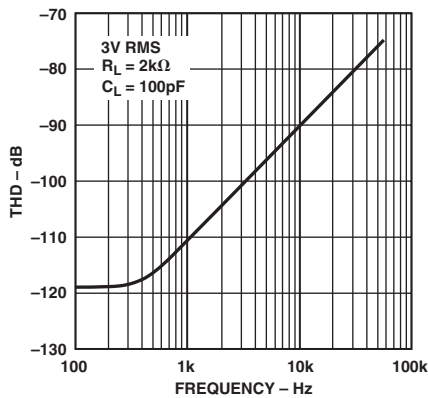

TPC 16. Total Harmonic Distortion vs. Frequency

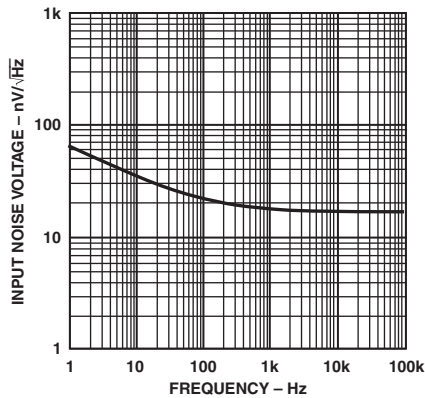

TPC 17. Input Noise Voltage Spectral Density

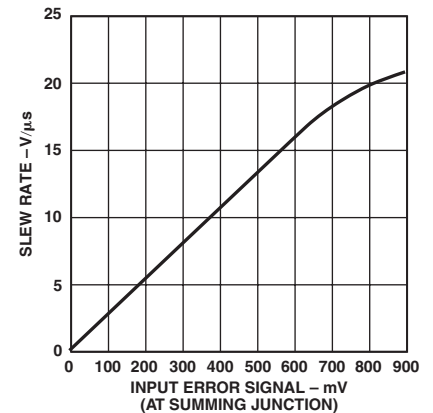

TPC 18. Slew Rate vs. Input Error Signal

AD711

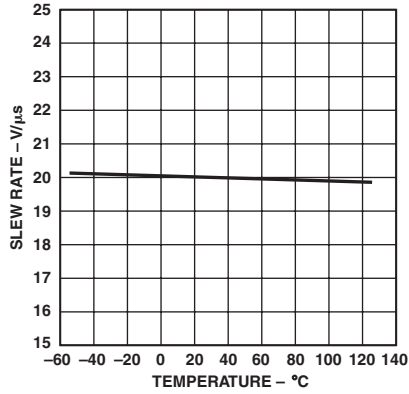

TPC 19. Slew Rate vs. Temperature

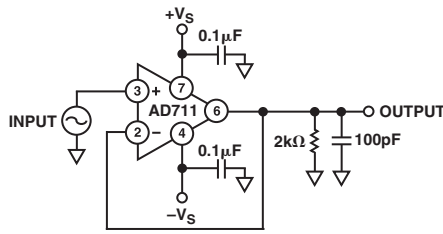

TPC 20. T.H.D. Test Circuit

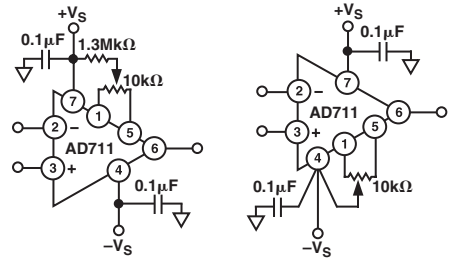

TPC 21. Offset Null Configurations

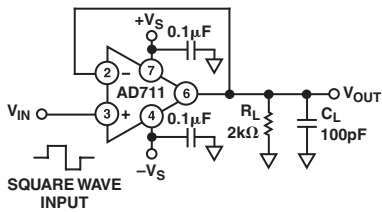

TPC 22a. Unity Gain Follower

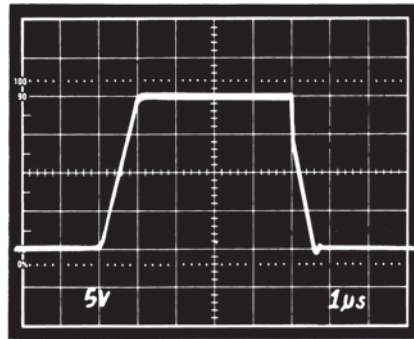

TPC 22b. Unity Gain Follower Pulse Response (Large Signal)

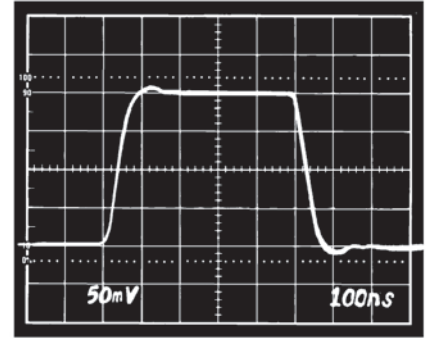

TPC 22c. Unity Gain Follower Pulse Response (Small Signal)

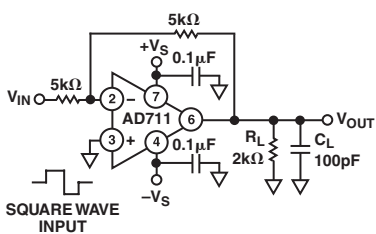

TPC 23a. Unity Gain Inverter

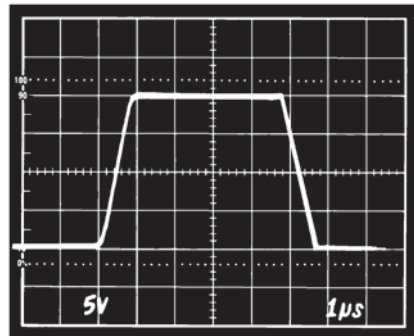

TPC 23b. Unity Gain Inverter Pulse Response (Large Signal)

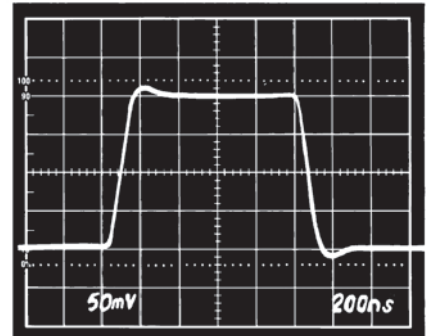

TPC 23c. Unity Gain Inverter Pulse Response (Small Signal)

OPTIMIZING SETTLING TIME

Most bipolar high-speed D/A converters have current outputs; therefore, for most applications, an external op amp is required for current-to-voltage conversion. The settling time of the converter/op amp combination depends on the settling time of the DAC and output amplifier. A good approximation is:

$$t_{S \text{ Total}} = \sqrt{(t_{S \text{ DAC}})^2 + (t_{S \text{ AMP}})^2} \quad (1)$$

The settling time of an op amp DAC buffer will vary with the noise gain of the circuit, the DAC output capacitance, and with the amount of external compensation capacitance across the DAC output scaling resistor.

Settling time for a bipolar DAC is typically 100 ns to 500 ns. Previously, conventional op amps have required much longer settling times than have typical state-of-the-art DACs; therefore, the amplifier settling time has been the major limitation to a high-speed voltage-output D-to-A function. The introduction of the AD711/712 family of op amps with their 1 μ s (to $\pm 0.01\%$ of final value) settling time now permits the full high-speed capabilities of most modern DACs to be realized.

In addition to a significant improvement in settling time, the low offset voltage, low offset voltage drift, and high open-loop gain of the AD711 family assures 12-bit accuracy over the full operating temperature range.

The excellent high-speed performance of the AD711 is shown in the oscilloscope photos of Figure 2. Measurements were taken using a low input capacitance amplifier connected directly to the summing junction of the AD711 – both photos show the worst case situation: a full-scale input transition. The DAC's 4 k Ω [10 k Ω ||8 k Ω = 4.4 k Ω] output impedance together with a 10 k Ω feedback resistor produce an op amp noise gain of 3.25. The current output from the DAC produces a 10 V step at the op amp output (0 to -10 V Figure 2a, -10 V to 0 V Figure 2b.)

Therefore, with an ideal op amp, settling to $\pm 1/2$ LSB ($\pm 0.01\%$) requires that 375 μ V or less appears at the summing junction. This means that the error between the input and output (that voltage which appears at the AD711 summing junction) must be less than 375 μ V. As shown in Figure 2, the total settling time for the AD711/AD565 combination is 1.2 microseconds.

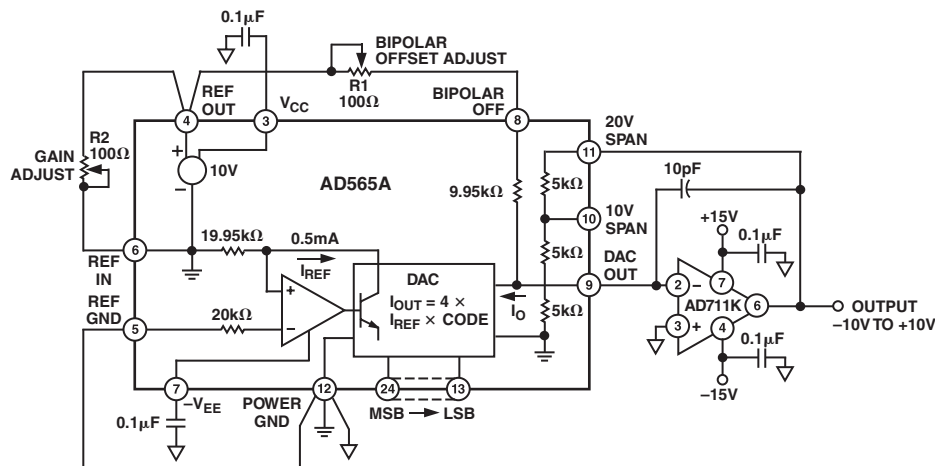

Figure 1. ± 10 V Voltage Output Bipolar DAC

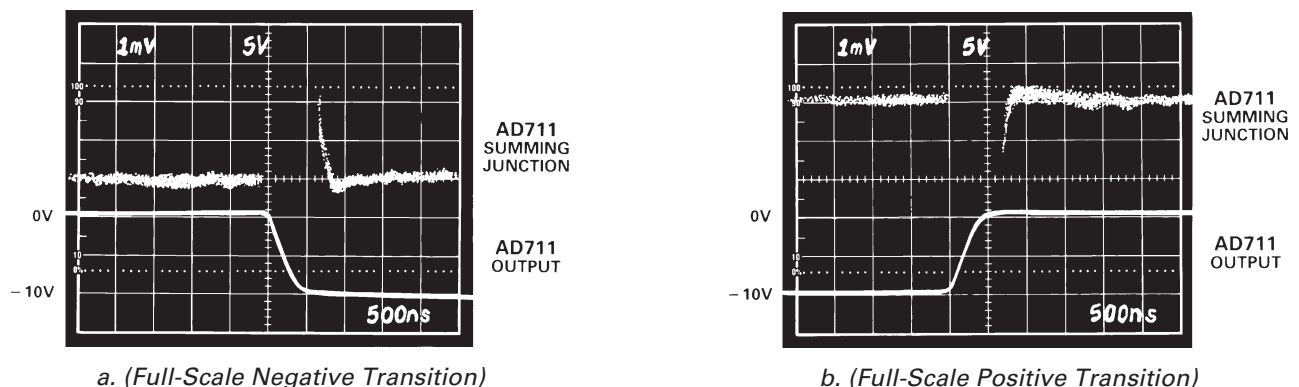

Figure 2. Settling Characteristics for AD711 with AD565A

AD711

OP AMP SETTLING TIME—A MATHEMATICAL MODEL

The design of the AD711 gives careful attention to optimizing individual circuit components; in addition, a careful tradeoff was made: the gain bandwidth product (4 MHz) and slew rate (20 V/μs) were chosen to be high enough to provide very fast settling time but not too high to cause a significant reduction in phase margin (and therefore stability). Thus designed, the AD711 settles to ±0.01%, with a 10 V output step, in under 1 μs, while retaining the ability to drive a 100 pF load capacitance when operating as a unity gain follower.

If an op amp is modeled as an ideal integrator with a unity gain crossover frequency of $\omega_0/2\pi$, Equation 1 will accurately describe the small signal behavior of the circuit of Figure 3a, consisting of an op amp connected as an I-to-V converter at the output of a bipolar or CMOS DAC. This equation would completely describe the output of the system if not for the op amp's finite slew rate and other nonlinear effects.

$$\frac{V_O}{I_{IN}} = \frac{-R}{\frac{R(C_f = C_X)}{\omega_0} s^2 + \left(\frac{G_N}{\omega_0} + RC_f\right) s + 1} \quad (3)$$

where:

$\frac{\omega_0}{2\pi}$ = op amp's unity gain frequency

G_N = "noise" gain of circuit $\left(1 + \frac{R}{R_O}\right)$

This equation may then be solved for C_f :

$$C_f = \frac{2 - G_N}{R\omega_0} + \frac{2\sqrt{RC_X\omega_0 + (1 - G_N)}}{R\omega_0} \quad (3)$$

In these equations, capacitor C_X is the total capacitor appearing the inverting terminal of the op amp. When modeling a DAC buffer application, the Norton equivalent circuit of Figure 3a can be used directly; capacitance C_X is the total capacitance of the output of the DAC plus the input capacitance of the op amp (since the two are in parallel).

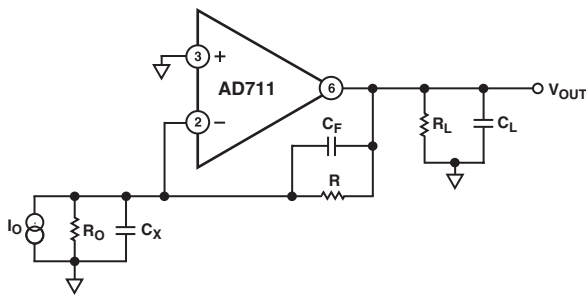

Figure 3a. Simplified Model of the AD711 Used as a Current-Out DAC Buffer

When R_O and I_O are replaced with their Thevenin V_{IN} and R_{IN} equivalents, the general purpose inverting amplifier of Figure 26b is created. Note that when using this general model, capacitance C_X is either the input capacitance of the op amp if a simple inverting

op amp is being simulated or it is the combined capacitance of the DAC output and the op amp input if the DAC buffer is being modeled.

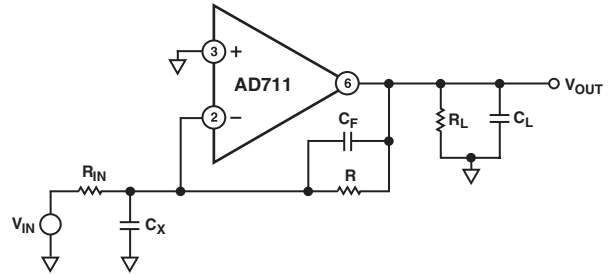

Figure 3b. Simplified Model of the AD711 Used as an Inverter

In either case, the capacitance C_X causes the system to go from a one-pole to a two-pole response; this additional pole increases settling time by introducing peaking or ringing in the op amp output. Since the value of C_X can be estimated with reasonable accuracy, Equation 2 can be used to choose a small capacitor, C_F , to cancel the input pole and optimize amplifier response. Figure 4 is a graphical solution of Equation 2 for the AD711 with $R = 4 \text{ k}\Omega$.

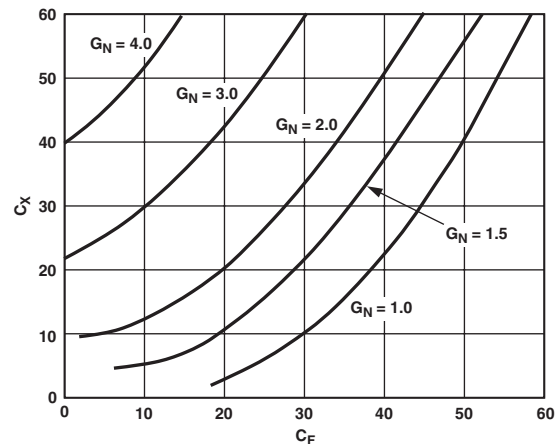

Figure 4. Value of Capacitor C_F vs. Value of C_X

The photos of Figures 5a and 5b show the dynamic response of the AD711 in the settling test circuit of Figure 6.

The input of the settling time fixture is driven by a flat-top pulse generator. The error signal output from the false summing node of A1 is clamped, amplified by A2 and then clamped again. The error signal is thus clamped twice: once to prevent overloading amplifier A2 and then a second time to avoid overloading the oscilloscope preamp. The Tektronix oscilloscope preamp type 7A26 was carefully chosen because it does not overload with these input levels. Amplifier A2 needs to be a very high speed FET-input op amp; it provides a gain of 10, amplifying the error signal output of A1.

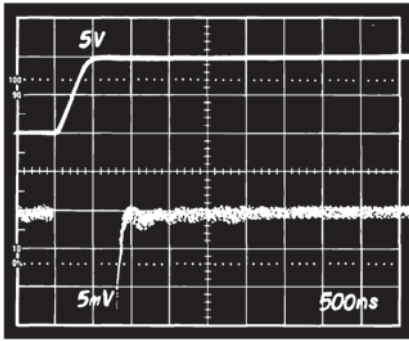

Figure 5a. Settling Characteristics 0 to +10 V Step
Upper Trace: Output of AD711 Under Test (5 V/Div)
Lower Trace: Amplified Error Voltage (0.01%/Div)

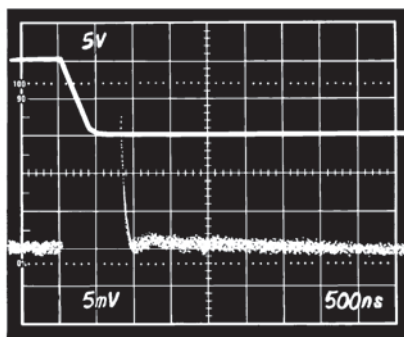

Figure 5b. Settling Characteristics 0 to -10 V Step
Upper Trace: Output of AD711 Under Test (5 V/Div)
Lower Trace: Amplified Error Voltage (0.01%/Div)

GUARDING

The low input bias current (15 pA) and low noise characteristics of the AD711 BiFET op amp make it suitable for electrometer applications such as photo diode preamplifiers and picoampere

current-to-voltage converters. The use of a guarding technique such as that shown in Figure 7, in printed circuit board layout and construction is critical to minimize leakage currents. The guard ring is connected to a low impedance potential at the same level as the inputs. High impedance signal lines should not be extended for any unnecessary length on the printed circuit board.

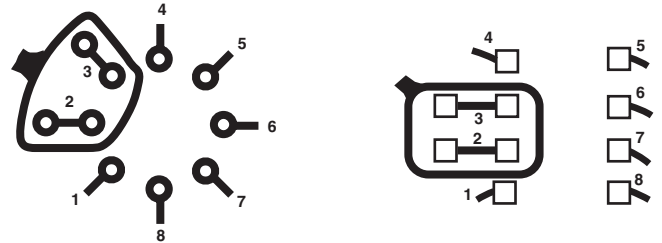

Figure 7. Board Layout for Guarding Inputs

D/A CONVERTER APPLICATIONS

The AD711 is an excellent output amplifier for CMOS DACs. It can be used to perform both 2-quadrant and 4-quadrant operation. The output impedance of a DAC using an inverted R-2R ladder approaches R for codes containing many 1s, 3R for codes containing a single 1, and for codes containing all zero, the output impedance is infinite.

For example, the output resistance of the AD7545 will modulate between 11 kΩ and 33 kΩ. Therefore, with the DAC's internal feedback resistance of 11 kΩ, the noise gain will vary from 2 to 4/3. This changing noise gain modulates the effect of the input offset voltage of the amplifier, resulting in nonlinear DAC amplifier performance.

The AD711K with guaranteed 500 μV offset voltage minimizes this effect to achieve 12-bit performance.

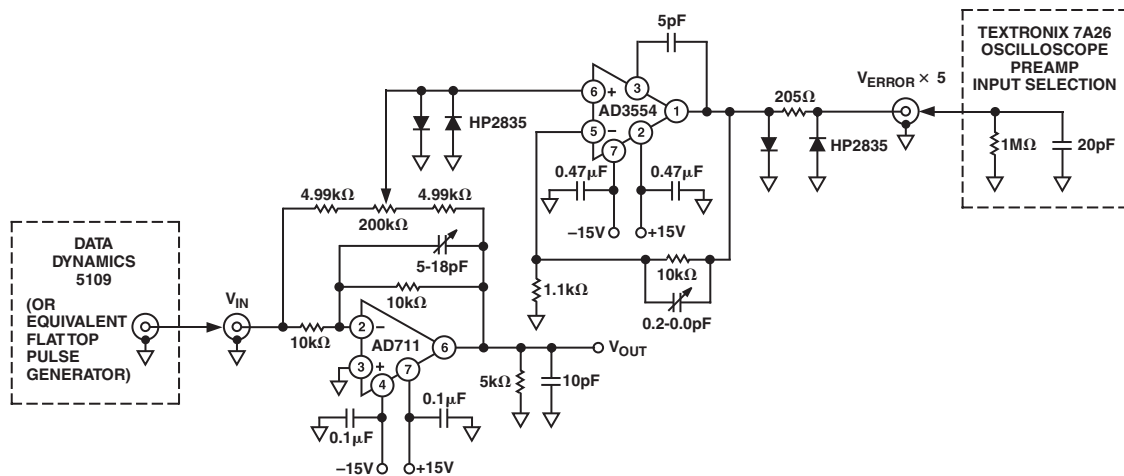

Figure 6. Settling Time Test Circuit

AD711

Figures 8 and 9 show the AD711 and AD7545 (12-bit CMOS DAC) configured for unipolar binary (2-quadrant multiplication) or bipolar (4-quadrant multiplication) operation. Capacitor C1 provides phase compensation to reduce overshoot and ringing.

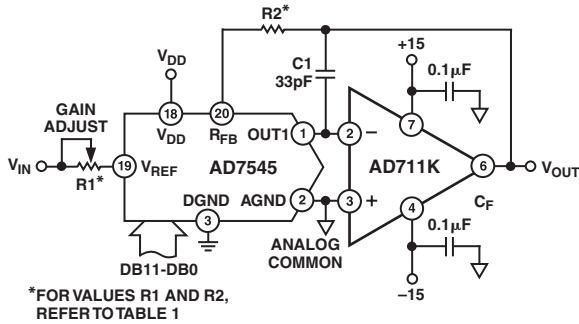

Figure 8. Unipolar Binary Operation

R1 and R2 calibrate the zero offset and gain error of the DAC. Specific values for these resistors depend upon the grade of AD7545 and are shown below.

Table I. Recommended Trim Resistor Values vs. Grades of the AD7545 for $V_{DD} = 5V$

TRIM RESISTOR	JN/AQ/SD	KN/BQ/TD	LN/CQ/UD	GLN/GCQ/GUD
R1	500 Ω	200 Ω	100 Ω	20 Ω
R2	150 Ω	68 Ω	33 Ω	6.8 Ω

NOISE CHARACTERISTICS

The random nature of noise, particularly in the $1/f$ region, makes it difficult to specify in practical terms. At the same time, designers of precision instrumentation require certain guaranteed maximum noise levels to realize the full accuracy of their equipment.

The AD711C grade is specified at a maximum level of 4.0 μV p-p, in a 0.1 Hz to 10 Hz bandwidth. Each AD711C receives a 100% noise test for two 10-second intervals; devices with any excursion in excess of 4.0 μV are rejected. The screened lot is then submitted to Quality Control for verification on an AQL basis.

All other grades of the AD711 are sample-tested on an AQL basis to a limit of 6 μV p-p, 0.1 to 10 Hz.

DRIVING THE ANALOG INPUT OF AN A/D CONVERTER

An op amp driving the analog input of an A/D converter, such as that shown in Figure 11, must be capable of maintaining a constant output voltage under dynamically changing load conditions. In successive-approximation converters, the input current is

compared to a series of switched trial currents. The comparison point is diode clamped but may deviate several hundred millivolts resulting in high frequency modulation of A/D input current.

Figures 10a and 10b show the settling time characteristics of the AD711 when used as a DAC output buffer for the AD7545.

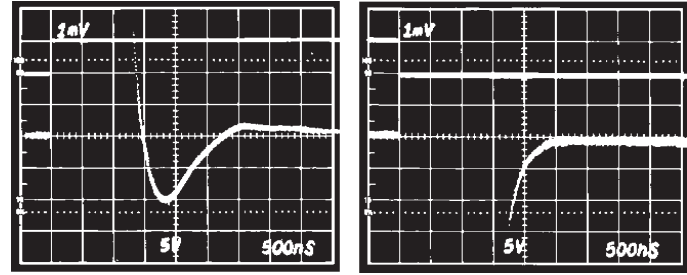

a. Full-Scale Positive Transition

b. Full-Scale Negative Transition

Figure 10. Settling Characteristics for AD711 with AD7545

compared to a series of switched trial currents. The comparison point is diode clamped but may deviate several hundred millivolts resulting in high frequency modulation of A/D input current. The output impedance of a feedback amplifier is made artificially low by the loop gain. At high frequencies, where the loop gain is low, the amplifier output impedance can approach its open loop value. Most IC amplifiers exhibit a minimum open loop output impedance of 25 Ω due to current limiting resistors. A few hundred microamps reflected from the change in converter loading can introduce errors in instantaneous input

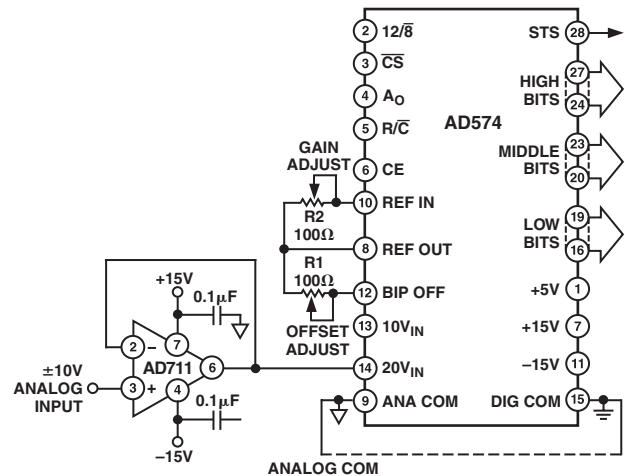

Figure 11. AD711 as ADC Unity Gain Buffer

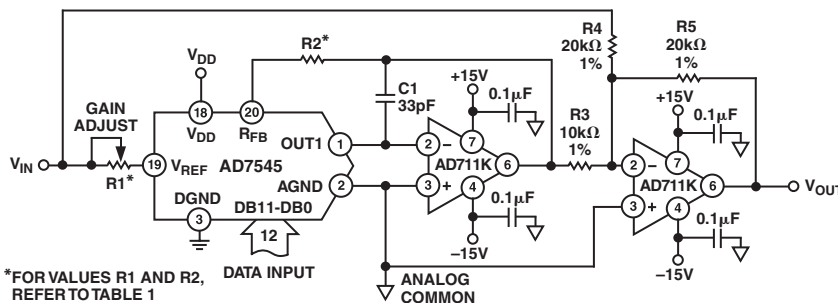
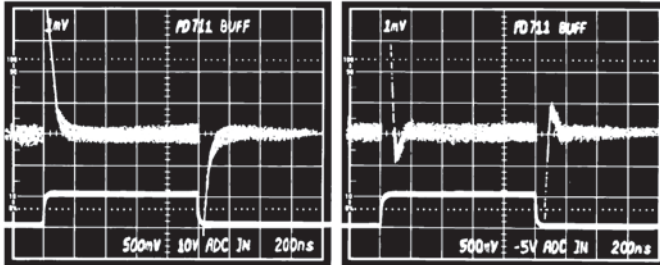

Figure 9. Bipolar Operation

voltage. If the A/D conversion speed is not excessive and the bandwidth of the amplifier is sufficient, the amplifier's output will return to the nominal value before the converter makes its comparison. However, many amplifiers have relatively narrow bandwidth yielding slow recovery from output transients. The AD711 is ideally suited to drive high speed A/D converters since it offers both wide bandwidth and high open-loop gain.



a. Source Current = 2 mA b. Sink Current = 1 mA

Figure 12. ADC Input Unity Gain Buffer Recovery Times

DRIVING A LARGE CAPACITIVE LOAD

The circuit in Figure 13 employs a 100 Ω isolation resistor which enables the amplifier to drive capacitive loads exceeding 1500 pF; the resistor effectively isolates the high frequency feedback from the load and stabilizes the circuit. Low frequency feedback is returned to the amplifier summing junction via the low pass filter formed by the 100 Ω series resistor and the load capacitance, C_L. Figure 14 shows a typical transient response for this connection.

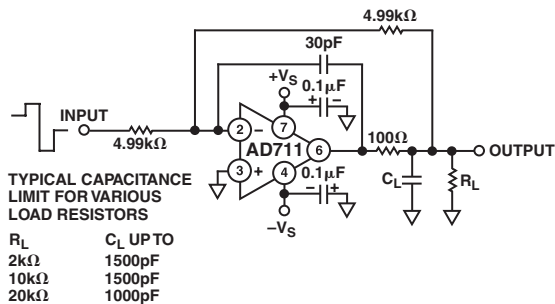

Figure 13. Circuit for Driving a Large Capacitive Load

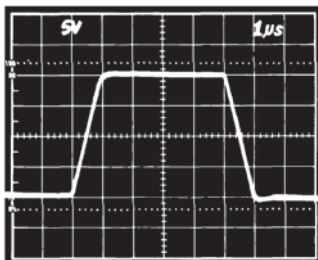

Figure 14. Transient Response R_L = 2 kΩ, C_L = 500 pF

ACTIVE FILTER APPLICATIONS

In active filter applications using op amps, the dc accuracy of the amplifier is critical to optimal filter performance. The amplifier's offset voltage and bias current contribute to output error. Offset voltage will be passed by the filter and may be amplified to produce excessive output offset. For low frequency applications requiring

large value input resistors, bias currents flowing through these resistors will also generate an offset voltage.

In addition, at higher frequencies, an op amp's dynamics must be carefully considered. Here, slew rate, bandwidth, and open-loop gain play a major role in op amp selection. The slew rate must be fast as well as symmetrical to minimize distortion. The amplifier's bandwidth in conjunction with the filter's gain will dictate the frequency response of the filter.

The use of a high performance amplifier such as the AD711 will minimize both dc and ac errors in all active filter applications.

SECOND ORDER LOW PASS FILTER

Figure 15 depicts the AD711 configured as a second order Butterworth low pass filter. With the values as shown, the corner frequency will be 20 kHz; however, the wide bandwidth of the AD711 permits a corner frequency as high as several hundred kilohertz. Equations for component selection are shown below.

$$R1 = R2 = \text{user selected (typical values: } 10 \text{ k}\Omega - 100 \text{ k}\Omega) \quad (4)$$

$$C1 = \frac{1.414}{(2\pi)(f_{\text{cutoff}})(R1)}, \quad C2 = \frac{0.707}{(2\pi)(f_{\text{cutoff}})(R1)} \quad (5)$$

Where:

C1 and C2 are in farads.

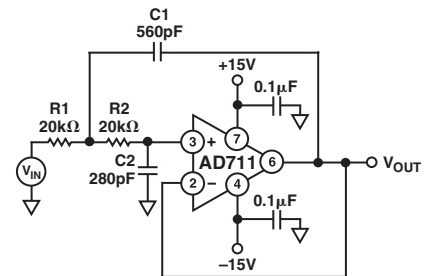

Figure 15. Second Order Low Pass Filter

An important property of filters is their out-of-band rejection. The simple 20 kHz low pass filter shown in Figure 15, might be used to condition a signal contaminated with clock pulses or sampling glitches which have considerable energy content at high frequencies.

The low output impedance and high bandwidth of the AD711 minimize high frequency feedthrough as shown in Figure 16.

The upper trace is that of another low-cost BiFET op amp showing 17 dB more feedthrough at 5 MHz.

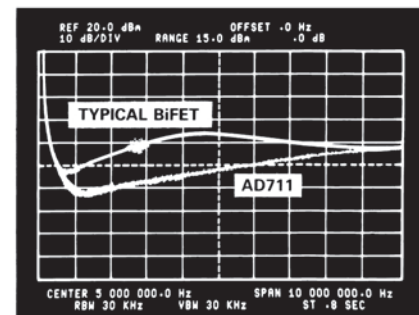

Figure 16.

AD711

9-POLE CHEBYCHEV FILTER

Figure 17 shows the AD711 and its dual counterpart, the AD712, as a 9-pole Chebychev filter using active frequency dependent negative resistors (FDNR). With a cutoff frequency of 50 kHz and better than 90 dB rejection, it may be used as an anti-aliasing filter for a 12-bit data acquisition system with 100 kHz throughput.

As shown in Figure 17, the filter is comprised of four FDNRs (A, B, C, D) having values of 4.9395×10^{-15} and 5.9276×10^{-15} farad-seconds. Each FDNR active network provides a

2-pole response; for a total of 8 poles. The 9th pole consists of a $0.001 \mu\text{F}$ capacitor and a $124 \text{ k}\Omega$ resistor at Pin 3 of amplifier A2.

Figure 18 depicts the circuits for each FDNR with the proper selection of R. To achieve optimal performance, the $0.001 \mu\text{F}$ capacitors must be selected for 1% or better matching and all resistors should have 1% or better tolerance.

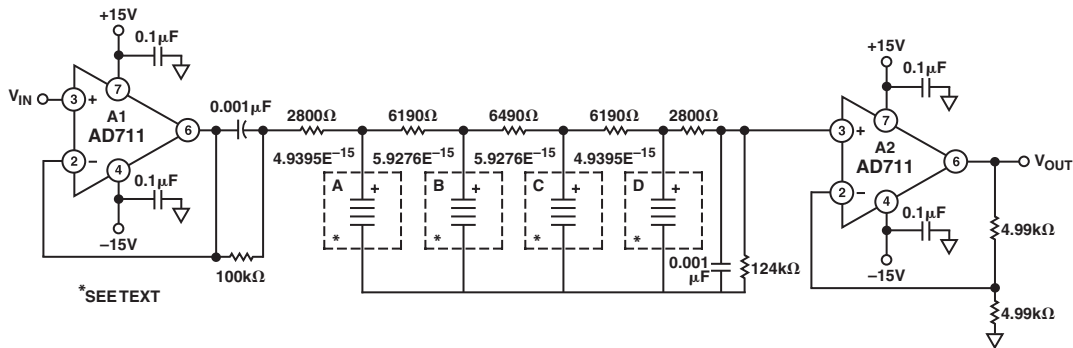

Figure 17. 9-Pole Chebychev Filter

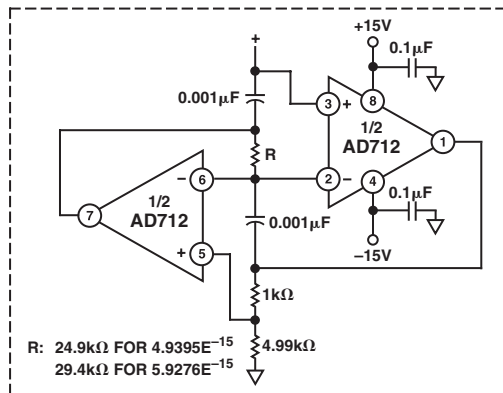

Figure 18. FDNR for 9-Pole Chebychev Filter

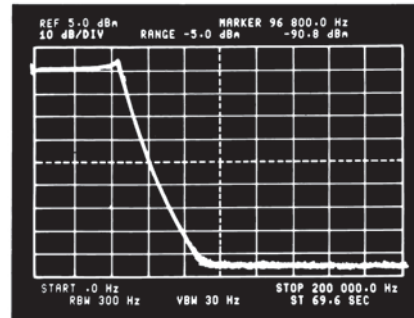
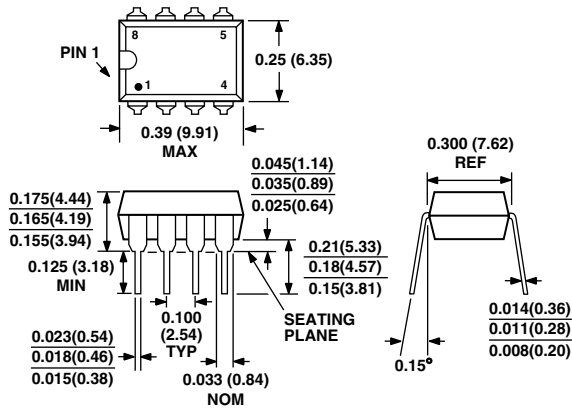

Figure 19. High Frequency Response for 9-Pole Chebychev Filter

OUTLINE DIMENSIONS

Dimensions shown in inches and (mm).

Mini-DIP Package (N-8)



Cerdip Package (Q-8)

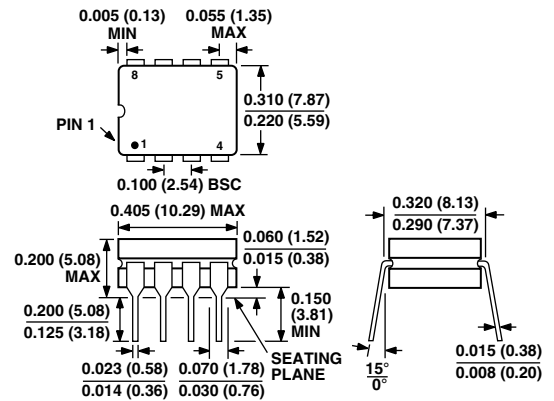

Small Outline Package (R-8)

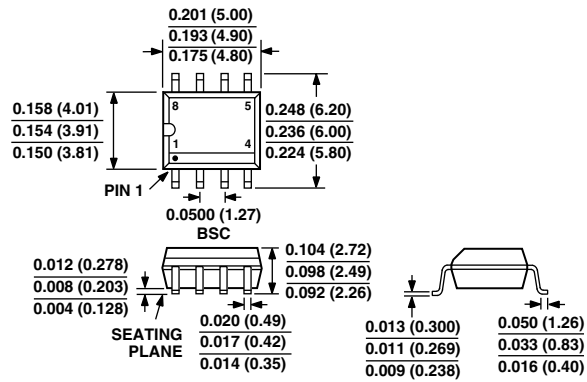

TO-99 Package (H-8)

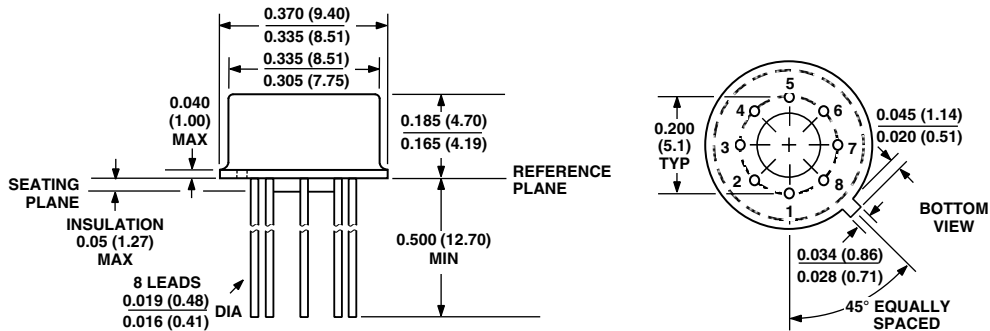

AD711

Revision History

Location	Page
Data Sheet changed from REV. A to REV. B.	
Edits to ORDERING GUIDE	3
Deleted METALIZATION PHOTOGRAPH	3

