

# 32K x 36 Bit Flow-Through BurstRAM Synchronous Fast Static RAM

The MCM69F536C is a 1M-bit synchronous fast static RAM designed to provide a burstable, high performance, secondary cache for the 68K Family, PowerPC™, 486, i960™, and Pentium™ microprocessors. It is organized as 32K words of 36 bits each. This device integrates input registers, a 2-bit address counter, and high speed SRAM onto a single monolithic circuit for reduced parts count in cache data RAM applications. Synchronous design allows precise cycle control with the use of an external clock (K). BiCMOS circuitry reduces the overall power consumption of the integrated functions for greater reliability.

Addresses (SA), data inputs (DQx), and all control signals except output enable ( $\overline{OE}$ ) and Linear Burst Order ( $\overline{LBO}$ ) are clock (K) controlled through positive-edge-triggered noninverting registers.

Bursts can be initiated with either  $\overline{ADSP}$  or  $\overline{ADSC}$  input pins. Subsequent burst addresses can be generated internally by the MCM69F536C (burst sequence operates in linear or interleaved mode dependent upon the state of  $\overline{LBO}$ ) and controlled by the burst address advance ( $\overline{ADV}$ ) input pin.

Write cycles are internally self-timed and are initiated by the rising edge of the clock (K) input. This feature eliminates complex off-chip write pulse generation and provides increased timing flexibility for incoming signals.

Synchronous byte write ( $\overline{SBx}$ ), synchronous global write ( $\overline{SGW}$ ), and synchronous write enable  $\overline{SW}$  are provided to allow writes to either individual bytes or to all bytes. The four bytes are designated as "a", "b", "c", and "d".  $\overline{SBa}$  controls DQa,  $\overline{SBb}$  controls DQb, and so on. Individual bytes are written if the selected byte writes  $\overline{SBx}$  are asserted with  $\overline{SW}$ . All bytes are written if either  $\overline{SGW}$  is asserted or if all  $\overline{SBx}$  and  $\overline{SW}$  are asserted.

For read cycles, a flow-through SRAM allows output data to simply flow freely from the memory array.

The MCM69F536C operates from a 3.3 V power supply and all inputs and outputs are LVTTTL compatible.

- MCM69F536C-8.5 = 8.5 ns Access / 12 ns Cycle
- MCM69F536C-9 = 9 ns Access / 12 ns Cycle
- MCM69F536C-10 = 10 ns Access / 15 ns Cycle
- MCM69F536C-12 = 12 ns Access / 16.6 ns Cycle
- Single 3.3 V + 10%, - 5% Power Supply
- $\overline{ADSP}$ ,  $\overline{ADSC}$ , and  $\overline{ADV}$  Burst Control Pins
- Selectable Burst Sequencing Order (Linear/Interleaved)
- Internally Self-Timed Write Cycle
- Byte Write and Global Write Control
- 5 V Tolerant on all Pins (Inputs and I/Os)
- 100-Pin TQFP Package

**MCM69F536C**

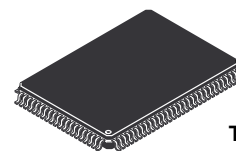

TQ PACKAGE  
TQFP  
CASE 983A-01

The PowerPC name is a trademark of IBM Corp., used under license therefrom.  
i960 and Pentium are trademarks of Intel Corp.

REV 3  
2/18/98

© Motorola, Inc. 1998



FUNCTIONAL BLOCK DIAGRAM

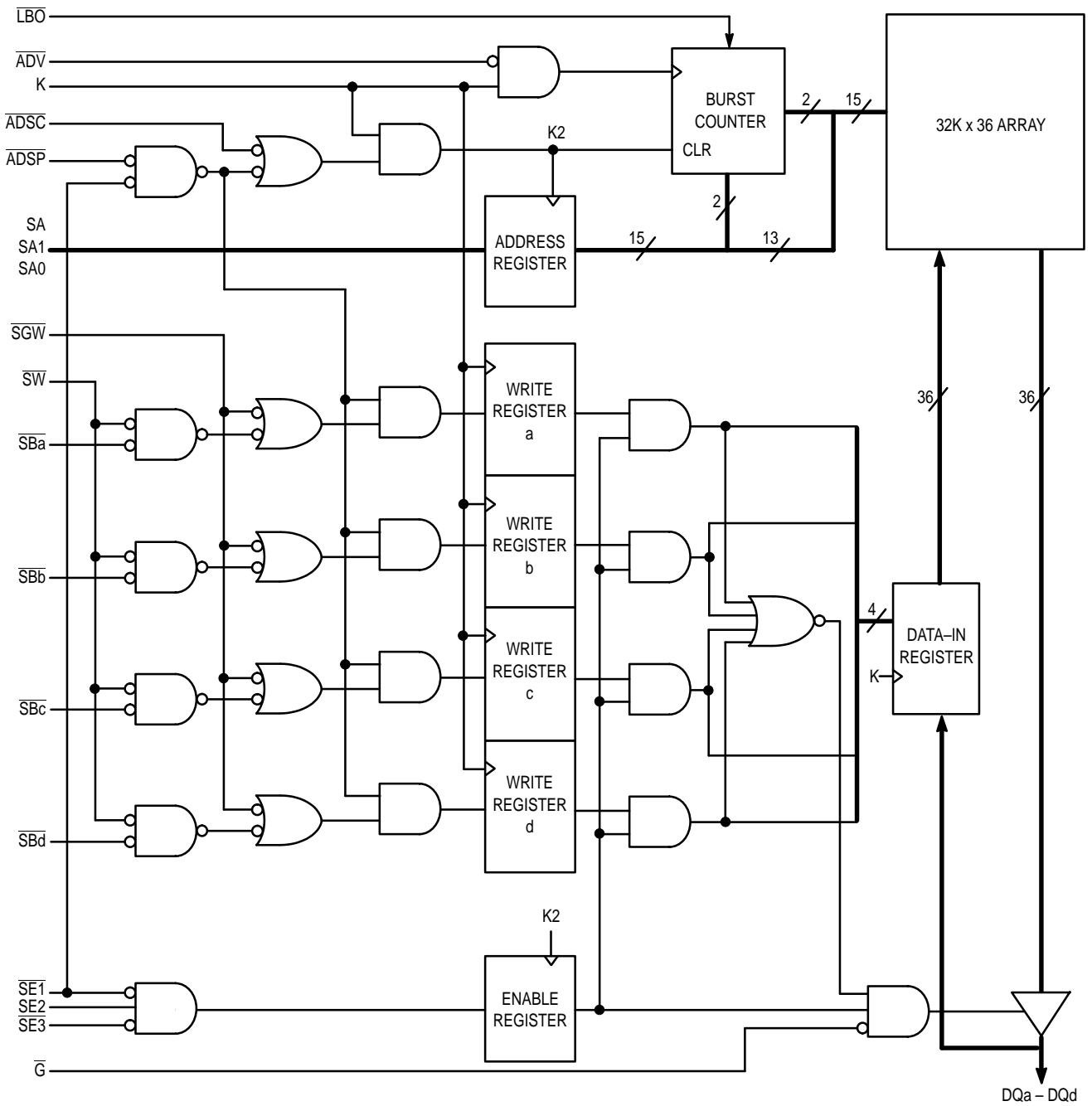

## PIN ASSIGNMENT

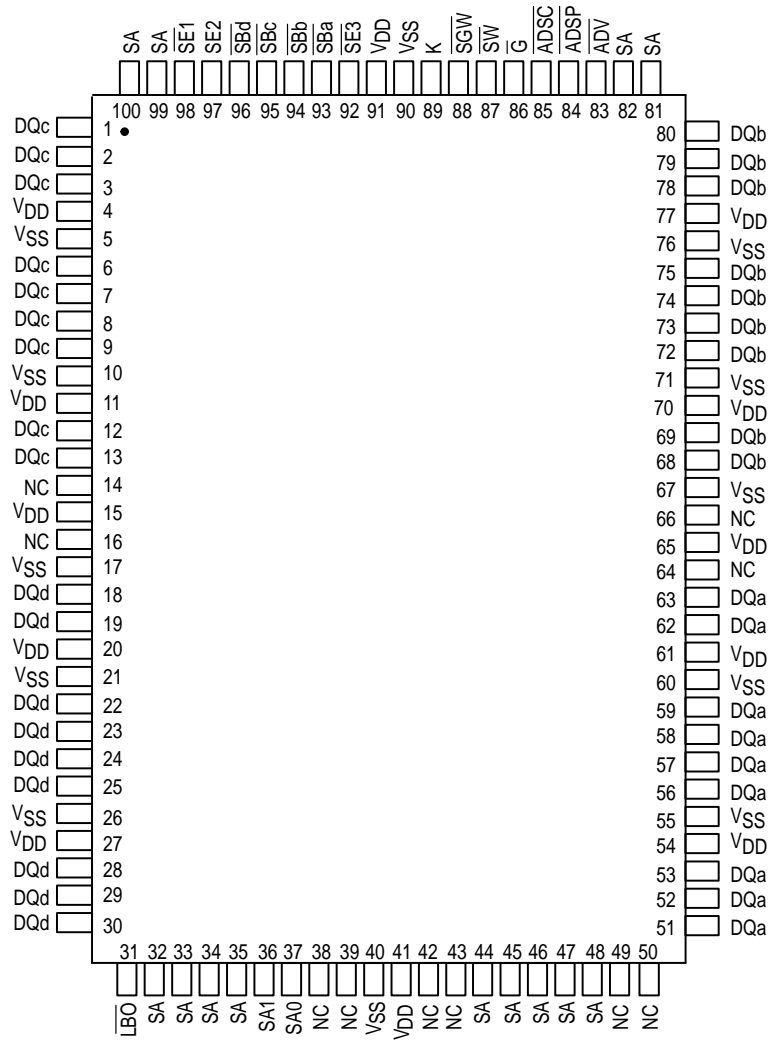

## PIN DESCRIPTIONS

Pin Locations	Symbol	Type	Description
85	$\overline{\text{ADSC}}$	Input	Synchronous Address Status Controller: Initiates READ, WRITE, or chip deselect cycle.
84	$\overline{\text{ADSP}}$	Input	Synchronous Address Status Processor: Initiates READ, WRITE, or chip deselect cycle (exception — chip deselect does not occur when $\overline{\text{ADSP}}$ is asserted and $\overline{\text{SE1}}$ is high).
83	$\overline{\text{ADV}}$	Input	Synchronous Address Advance: Increments address count in accordance with counter type selected (linear/interleaved).
(a) 51, 52, 53, 56, 57, 58, 59, 62, 63 (b) 68, 69, 72, 73, 74, 75, 78, 79, 80 (c) 1, 2, 3, 6, 7, 8, 9, 12, 13 (d) 18, 19, 22, 23, 24, 25, 28, 29, 30	DQx	I/O	Synchronous Data I/O: "x" refers to the byte being read or written (byte a, b, c, d).
86	$\overline{\text{G}}$	Input	Asynchronous Output Enable Input: Low — enables output buffers (DQx pins). High — DQx pins are high impedance.
89	K	Input	Clock: This signal registers the address, data in, and all control signals except $\overline{\text{G}}$ and $\overline{\text{LBO}}$ .
31	$\overline{\text{LBO}}$	Input	Linear Burst Order Input: This pin must remain in steady state (this signal not registered or latched). It must be tied high or low. Low — linear burst count (68K/PowerPC). High — interleaved burst count (486/i960/Pentium).
32, 33, 34, 35, 44, 45, 46, 47, 48, 81, 82, 99, 100	SA	Input	Synchronous Address Inputs: These inputs are registered and must meet setup and hold times.
36, 37	SA1, SA0	Input	Synchronous Address Inputs: These pins must be wired to the two LSBs of the address bus for proper burst operation. These inputs are registered and must meet setup and hold times.
93, 94, 95, 96 (a) (b) (c) (d)	$\overline{\text{SBx}}$	Input	Synchronous Byte Write Inputs: "x" refers to the byte being written (byte a, b, c, d). $\overline{\text{SGW}}$ overrides $\overline{\text{SBx}}$ .
98	$\overline{\text{SE1}}$	Input	Synchronous Chip Enable: Active low to enable chip. Negated high — blocks $\overline{\text{ADSP}}$ or deselects chip when $\overline{\text{ADSC}}$ is asserted.
97	SE2	Input	Synchronous Chip Enable: Active high for depth expansion.
92	$\overline{\text{SE3}}$	Input	Synchronous Chip Enable: Active low for depth expansion.
88	$\overline{\text{SGW}}$	Input	Synchronous Global Write: This signal writes all bytes regardless of the status of the $\overline{\text{SBx}}$ and $\overline{\text{SW}}$ signals. If only byte write signals $\overline{\text{SBx}}$ are being used, tie this pin high.
87	$\overline{\text{SW}}$	Input	Synchronous Write: This signal writes only those bytes that have been selected using the byte write $\overline{\text{SBx}}$ pins. If only byte write signals $\overline{\text{SBx}}$ are being used, tie this pin low.
4, 11, 15, 20, 27, 41, 54, 61, 65, 70, 77, 91	V <sub>DD</sub>	Supply	Power Supply: 3.3 V + 10%, – 5%.
5, 10, 17, 21, 26, 40, 55, 60, 67, 71, 76, 90	V <sub>SS</sub>	Supply	Ground.
64	NC	Input	No Connection: There is no connection to the chip. For compatibility reasons, it is recommended that this pin be tied low for system designs that do not have a sleep mode associated with the cache/memory controller. Other vendors' RAMs may have implemented this Sleep Mode (ZZ) feature.
14, 16, 38, 39, 42, 43, 49, 50, 66	NC	—	No Connection: There is no connection to the chip.

**TRUTH TABLE** (See Notes 1 through 4)

Next Cycle	Address Used	$\overline{SE1}$	SE2	$\overline{SE3}$	$\overline{ADSP}$	$\overline{ADSC}$	$\overline{ADV}$	$\overline{G}^3$	DQx	Write 2, 4
Deselect	None	1	X	X	X	0	X	X	High-Z	X
Deselect	None	0	X	1	0	X	X	X	High-Z	X
Deselect	None	0	0	X	0	X	X	X	High-Z	X
Deselect	None	X	X	1	1	0	X	X	High-Z	X
Deselect	None	X	0	X	1	0	X	X	High-Z	X
Begin Read	External	0	1	0	0	X	X	0	DQ	READ
Begin Read	External	0	1	0	1	0	X	0	DQ	READ
Continue Read	Next	X	X	X	1	1	0	1	High-Z	READ
Continue Read	Next	X	X	X	1	1	0	0	DQ	READ
Continue Read	Next	1	X	X	X	1	0	1	High-Z	READ
Continue Read	Next	1	X	X	X	1	0	0	DQ	READ
Suspend Read	Current	X	X	X	1	1	1	1	High-Z	READ
Suspend Read	Current	X	X	X	1	1	1	0	DQ	READ
Suspend Read	Current	1	X	X	X	1	1	1	High-Z	READ
Suspend Read	Current	1	X	X	X	1	1	0	DQ	READ
Begin Write	Current	X	X	X	1	1	1	X	High-Z	WRITE
Begin Write	Current	1	X	X	X	1	1	X	High-Z	WRITE
Begin Write	External	0	1	0	1	0	X	X	High-Z	WRITE
Continue Write	Next	X	X	X	1	1	0	X	High-Z	WRITE
Continue Write	Next	1	X	X	X	1	0	X	High-Z	WRITE
Suspend Write	Current	X	X	X	1	1	1	X	High-Z	WRITE
Suspend Write	Current	1	X	X	X	1	1	X	High-Z	WRITE

NOTES: 1. X = Don't Care. 1 = logic high. 0 = logic low.

2. Write is defined as either 1) any  $\overline{SBx}$  and SW low or 2)  $\overline{SGW}$  is low.

3.  $\overline{G}$  is an asynchronous signal and is not sampled by the clock K.  $\overline{G}$  drives the bus immediately ( $t_{GLQX}$ ) following  $\overline{G}$  going low.

4. On write cycles that follow read cycles,  $\overline{G}$  must be negated prior to the start of the write cycle to ensure proper write data setup times.  $\overline{G}$  must also remain negated at the completion of the write cycle to ensure proper write data hold times.

**LINEAR BURST ADDRESS TABLE** ( $\overline{LB0} = V_{SS}$ )

1st Address (External)	2nd Address (Internal)	3rd Address (Internal)	4th Address (Internal)
X...X00	X...X01	X...X10	X...X11
X...X01	X...X10	X...X11	X...X00
X...X10	X...X11	X...X00	X...X01
X...X11	X...X00	X...X01	X...X10

**INTERLEAVED BURST ADDRESS TABLE** ( $\overline{LB0} = V_{DD}$ )

1st Address (External)	2nd Address (Internal)	3rd Address (Internal)	4th Address (Internal)
X...X00	X...X01	X...X10	X...X11
X...X01	X...X00	X...X11	X...X10
X...X10	X...X11	X...X00	X...X01
X...X11	X...X10	X...X01	X...X00

**WRITE TRUTH TABLE**

Cycle Type	SGW	SW	SBa	SBb	SBc	SBd
Read	H	H	X	X	X	X
Read	H	L	H	H	H	H
Write Byte a	H	L	L	H	H	H
Write Byte b	H	L	H	L	H	H
Write Byte c	H	L	H	H	L	H
Write Byte d	H	L	H	H	H	L
Write All Bytes	H	L	L	L	L	L
Write All Bytes	L	X	X	X	X	X

**ABSOLUTE MAXIMUM RATINGS** (See Note 1)

Rating	Symbol	Value	Unit
Power Supply Voltage	$V_{DD}$	- 0.5 to + 4.6	V
Voltage Relative to $V_{SS}$ for Any Pin Except $V_{DD}$	$V_{in}, V_{out}$	- 0.5 to 6.0	V
Output Current (per I/O)	$I_{out}$	$\pm 20$	mA
Package Power Dissipation (See Note 2)	$P_D$	1.6	W
Temperature Under Bias	$T_{bias}$	- 10 to 85	$^{\circ}C$
Storage Temperature	$T_{stg}$	- 55 to 125	$^{\circ}C$

This device contains circuitry to protect the inputs against damage due to high static voltages or electric fields; however, it is advised that normal precautions be taken to avoid application of any voltage higher than maximum rated voltages to this high-impedance circuit.

## NOTES:

1. Permanent device damage may occur if ABSOLUTE MAXIMUM RATINGS are exceeded. Functional operation should be restricted to RECOMMENDED OPERATING CONDITIONS. Exposure to higher than recommended voltages for extended periods of time could affect device reliability.
2. Power dissipation capability is dependent upon package characteristics and use environment. See Package Thermal Characteristics.

**PACKAGE THERMAL CHARACTERISTICS**

Rating	Symbol	Max	Unit	Notes
Thermal Resistance Junction to Ambient (@ 200 lfm) Single-Layer Board Four-Layer Board	$R_{\theta JA}$	40 25	$^{\circ}C/W$	1, 2
Thermal Resistance Junction to Board (Bottom)	$R_{\theta JB}$	17	$^{\circ}C/W$	1, 3
Thermal Resistance Junction to Case (Top)	$R_{\theta JC}$	9	$^{\circ}C/W$	1, 4

## NOTES:

1. Junction temperature is a function of on-chip power dissipation, package thermal resistance, mounting site (board) temperature, ambient temperature, air flow, board population, and board thermal resistance.
2. Per SEMI G38-87.
3. Indicates the average thermal resistance between the die and the printed circuit board.
4. Indicates the average thermal resistance between the die and the case top surface via the cold plate method (MIL SPEC-883 Method 1012.1).

**DC OPERATING CONDITIONS AND CHARACTERISTICS**  
( $V_{DD} = 3.3\text{ V} + 10\%, -5\%$ ,  $T_A = 0\text{ to }70^\circ\text{C}$ , Unless Otherwise Noted)

**RECOMMENDED OPERATING CONDITIONS** (Voltages Referenced to  $V_{SS} = 0\text{ V}$ )

Parameter	Symbol	Min	Typ	Max	Unit
Supply Voltage	$V_{DD}$	3.135	3.3	3.6	V
Input Low Voltage	$V_{IL}$	-0.5*	—	0.8	V
Input High Voltage	$V_{IH}$	2.0	—	5.5**	V

\*  $V_{IL} \geq -2\text{ V}$  for  $t \leq t_{KHKH}/2$ .

\*\*  $V_{IH} \leq 6\text{ V}$  for  $t_{KHKH}/2$ .

**DC CHARACTERISTICS AND SUPPLY CURRENTS**

Parameter	Symbol	Min	Max	Unit	Notes
Input Leakage Current ( $0\text{ V} \leq V_{in} \leq V_{DD}$ ) (Excluding $\overline{LB0}$ )	$I_{kg(I)}$	—	$\pm 1$	$\mu\text{A}$	
Output Leakage Current ( $0\text{ V} \leq V_{in} \leq V_{DD}$ )	$I_{kg(O)}$	—	$\pm 1$	$\mu\text{A}$	
AC Supply Current (Device Selected, All Outputs Open, All Inputs Toggling at $V_{in} \leq V_{IL}$ or $\geq V_{IH}$ , Cycle Time $\geq t_{KHKH}$ min)	$I_{DDA}$	—	320 320 310 300	mA	1, 2, 3
CMOS Standby Supply Current (Deselected, Clock (K) Cycle Time $\geq t_{KHKH}$ , All Inputs Toggling at CMOS Levels $V_{in} \leq V_{SS} + 0.2\text{ V}$ or $\geq V_{DD} - 0.2\text{ V}$ )	$I_{SB1}$	—	150 150 140 130	mA	4
Clock Running Supply Current (Deselected, Clock (K) Cycle Time $\geq t_{KHKH}$ , All Other Inputs Held to Static CMOS Levels $V_{in} \leq V_{SS} + 0.2\text{ V}$ or $\geq V_{DD} - 0.2\text{ V}$ )	$I_{SB2}$	—	55 55 50 45	mA	4
Output Low Voltage ( $I_{OL} = 8\text{ mA}$ )	$V_{OL}$	—	0.4	V	
Output High Voltage ( $I_{OH} = -4\text{ mA}$ )	$V_{OH}$	2.4	—	V	

NOTES:

1. Reference AC Operating Conditions and Characteristics for input and timing.
2. All addresses transition simultaneously low (LSB) and then high (HSB).
3. Data states are all zero.
4. Device in deselected mode as defined by the Truth Table.

**CAPACITANCE** ( $f = 1.0\text{ MHz}$ ,  $dV = 3.0\text{ V}$ ,  $T_A = 25^\circ\text{C}$ , Periodically Sampled Rather Than 100% Tested)

Parameter	Symbol	Min	Typ	Max	Unit
Input Capacitance	$C_{in}$	—	4	6	pF
Input/Output Capacitance	$C_{I/O}$	—	7	9	pF

**AC OPERATING CONDITIONS AND CHARACTERISTICS**  
 (V<sub>DD</sub> = 3.3 V + 10%, - 5%, T<sub>A</sub> = 0 to 70°C, Unless Otherwise Noted)

Input Timing Measurement Reference Level ..... 1.5 V  
 Input Pulse Levels ..... 0 to 3.0 V  
 Input Rise/Fall Time ..... 1 V/ns (20% to 80%)

Output Timing Reference Level ..... 1.5 V  
 Output Load ..... See Figure 1 Unless Otherwise Noted

**READ/WRITE CYCLE TIMING** (See Notes 1, 2, and 3)

Parameter	Symbol	69F536C-8.5		69F536C-9		69F536C-10		69F536C-12		Unit	Notes
		Min	Max	Min	Max	Min	Max	Min	Max		
Cycle Time	t <sub>KHKH</sub>	12	—	12	—	15	—	16.6	—	ns	
Clock High Pulse Width	t <sub>KHKL</sub>	4	—	4	—	5	—	6	—	ns	
Clock Low Pulse Width	t <sub>KLKH</sub>	4	—	4	—	5	—	6	—	ns	
Clock Access Time	t <sub>KHQV</sub>	—	8.5	—	9	—	10	—	12	ns	
Output Enable to Output Valid	t <sub>GLQV</sub>	—	5	—	5	—	5	—	6	ns	
Clock High to Output Active	t <sub>KHQX1</sub>	0	—	0	—	0	—	0	—	ns	4
Clock High to Output Change	t <sub>KHQX2</sub>	3	—	3	—	3	—	3	—	ns	4
Output Enable to Output Active	t <sub>GLQX</sub>	0	—	0	—	0	—	0	—	ns	4
Output Disable to Q High-Z	t <sub>GHQZ</sub>	—	5	—	5	—	5	—	6	ns	4, 5
Clock High to Q High-Z	t <sub>KHQZ</sub>	2.5	5	3	5	3	5	3	6	ns	4, 5
Setup Times: Address ADSP, ADSC, ADV Data In Write Chip Enable	t <sub>ADKH</sub> t <sub>ADSKH</sub> t <sub>DVKH</sub> t <sub>WVKH</sub> t <sub>EVKH</sub>	2.5	—	2.5	—	2.5	—	2.5	—	ns	
Hold Times: Address ADSP, ADSC, ADV Data In Write Chip Enable	t <sub>KHAX</sub> t <sub>KHADSX</sub> t <sub>KHDX</sub> t <sub>KHWX</sub> t <sub>KHEX</sub>	0.5	—	0.5	—	0.5	—	0.5	—	ns	

**NOTES:**

1. Write is defined as either any  $\overline{SBx}$  and  $\overline{SW}$  low or  $\overline{SGW}$  is low. Chip Enable is defined as  $\overline{SE1}$  low, SE2 high, and  $\overline{SE3}$  low whenever  $\overline{ADSP}$  or  $\overline{ADSC}$  is asserted.
2. All read and write cycle timings are referenced from K or  $\overline{G}$ .
3.  $\overline{G}$  is a don't care after write cycle begins. To prevent bus contention,  $\overline{G}$  should be negated prior to start of write cycle.
4. This parameter is sampled and not 100% tested.
5. Measured at  $\pm 200$  mV from steady state.

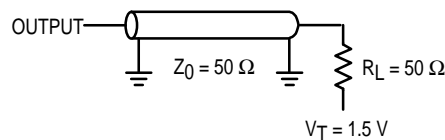

**Figure 1. AC Test Load**



READ/WRITE CYCLES

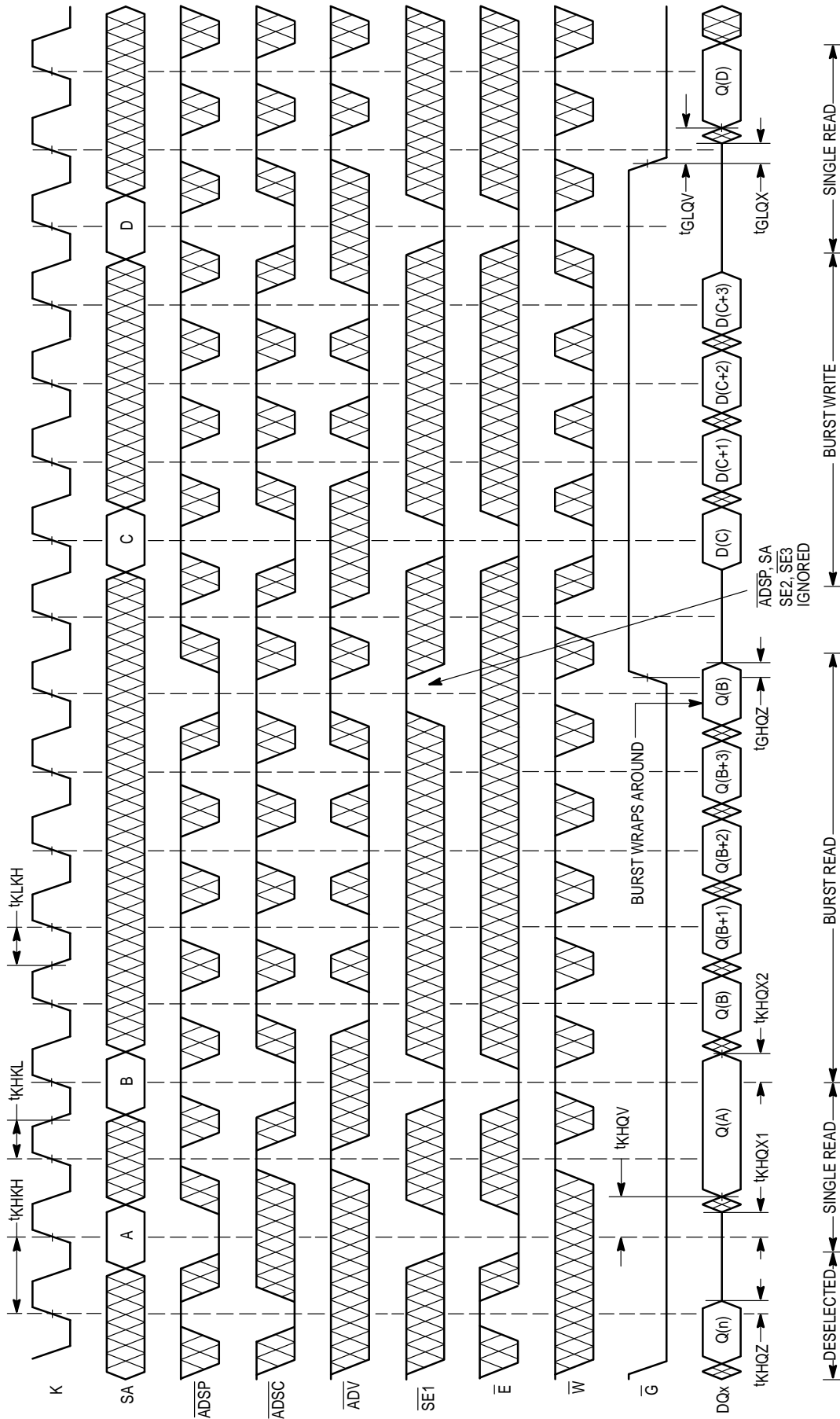

NOTE:  $\bar{E}$  low = SE2 high and SE3 low.  
 W low = SGW low and/or SW and SBx low.

## APPLICATION INFORMATION

The MCM69F536C BurstRAM is a high speed synchronous SRAM that is intended for use primarily in secondary or level two (L2) cache memory applications. L2 caches are found in a variety of classes of computers — from the desktop personal computer to the high-end servers and transaction processing machines. For simplicity, the majority of L2 caches today are direct mapped and are single bank implementations. These caches tend to be designed for bus speeds in the range of 33 to 66 MHz. At these bus rates, flow-through (non-pipelined) BurstRAMs can be used since their access times meet the speed requirements for a minimum-latency, zero-wait state L2 cache interface. Latency is a measure (time) of “dead” time the memory system exhibits as a result of a memory request.

For those applications that demand bus operation at greater than 66 MHz or multi-bank L2 caches at 66 MHz, the pipelined (register/register) version of the 32K x 36 BurstRAM (MCM69P536) allows the designer to maintain zero-wait state operation. Multiple banks of BurstRAMs create additional bus loading and can cause the system to otherwise miss its timing requirements. The access time (clock-to-valid-data) of a pipelined BurstRAM is inherently faster than a non-pipelined device by a few nanoseconds. This does not come without cost. The cost is latency — “dead” time.

For L2 cache designs that must minimize both latency and wait states, flow-through BurstRAMs are the best choice in achieving the highest performance in L2 cache design.

### NON-BURST SYNCHRONOUS OPERATION

Although this BurstRAM has been designed for 68K-, PowerPC-, 486-, i960-, and Pentium-based systems, these SRAMs can be used in other high speed L2 cache or memory applications that do not require the burst address feature. Most L2 caches designed with a synchronous interface can make use of the MCM69F536C. The burst counter feature of the BurstRAM can be disabled, and the SRAM can be configured to act upon a continuous stream of addresses. See Figure 2.

### CONTROL PIN TIE VALUES EXAMPLE ( $H \geq V_{IH}$ , $L \leq V_{IL}$ )

Non-Burst	ADSP	ADSC	ADV	SE1	SE2	LBO
Sync Non-Burst, Flow-Through SRAM	H	L	H	L	H	X

NOTE: Although X is specified in the table as a don't care, the pin must be tied either high or low.

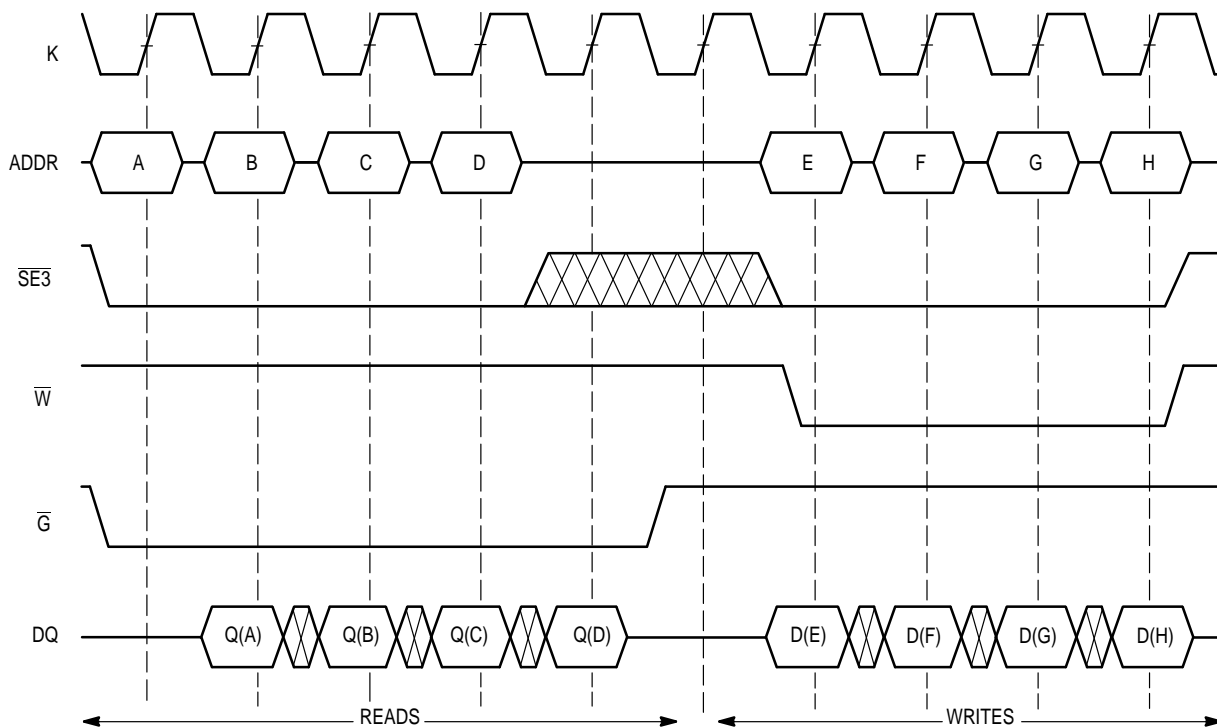
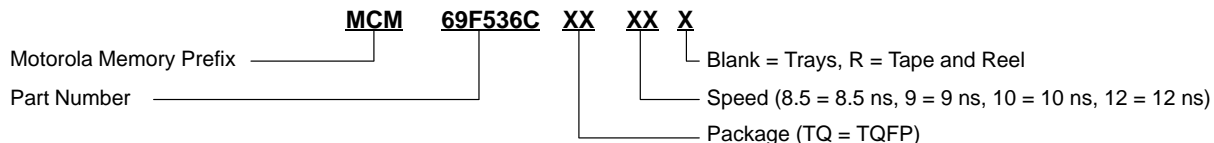



Figure 2. Example Configuration as Non-Burst Synchronous SRAM

## ORDERING INFORMATION

(Order by Full Part Number)



Full Part Numbers — MCM69F536CTQ8.5 MCM69F536CTQ9 MCM69F536CTQ10 MCM69F536CTQ12  
MCM69F536CTQ8.5R MCM69F536CTQ9R MCM69F536CTQ10R MCM69F536CTQ12R

Motorola reserves the right to make changes without further notice to any products herein. Motorola makes no warranty, representation or guarantee regarding the suitability of its products for any particular purpose, nor does Motorola assume any liability arising out of the application or use of any product or circuit, and specifically disclaims any and all liability, including without limitation consequential or incidental damages. "Typical" parameters which may be provided in Motorola data sheets and/or specifications can and do vary in different applications and actual performance may vary over time. All operating parameters, including "Typicals" must be validated for each customer application by customer's technical experts. Motorola does not convey any license under its patent rights nor the rights of others. Motorola products are not designed, intended, or authorized for use as components in systems intended for surgical implant into the body, or other applications intended to support or sustain life, or for any other application in which the failure of the Motorola product could create a situation where personal injury or death may occur. Should Buyer purchase or use Motorola products for any such unintended or unauthorized application, Buyer shall indemnify and hold Motorola and its officers, employees, subsidiaries, affiliates, and distributors harmless against all claims, costs, damages, and expenses, and reasonable attorney fees arising out of, directly or indirectly, any claim of personal injury or death associated with such unintended or unauthorized use, even if such claim alleges that Motorola was negligent regarding the design or manufacture of the part. Motorola and  are registered trademarks of Motorola, Inc. Motorola, Inc. is an Equal Opportunity/Affirmative Action Employer.

# PACKAGE DIMENSIONS

## TQ PACKAGE TQFP CASE 983A-01

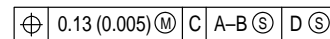
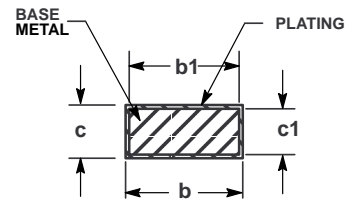
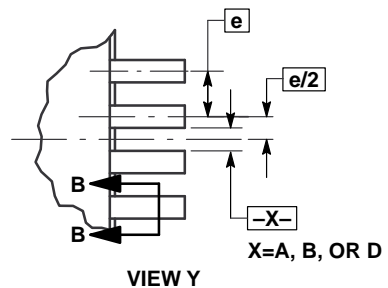
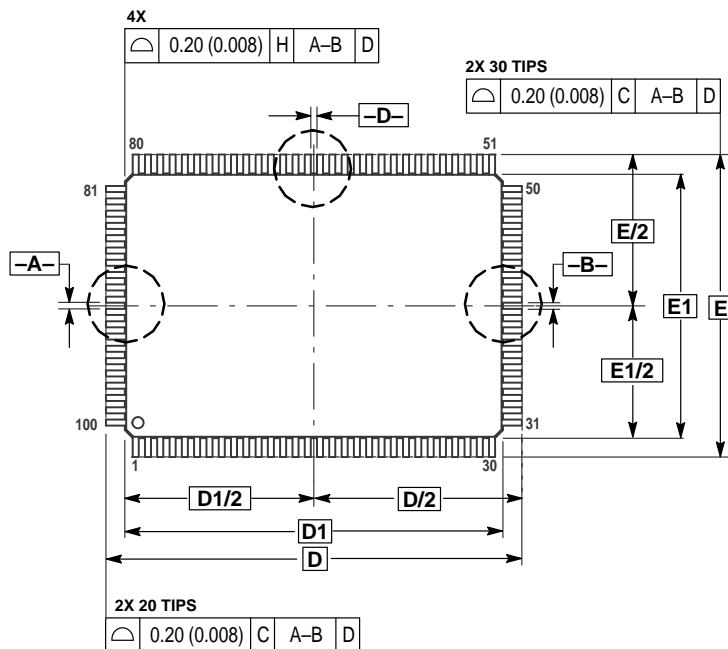

### NOTES:

- DIMENSIONING AND TOLERANCING PER ANSI Y14.5M, 1982.
- CONTROLLING DIMENSION: MILLIMETER.
- DATUM PLANE -H- IS LOCATED AT BOTTOM OF LEAD AND IS COINCIDENT WITH THE LEAD WHERE THE LEAD EXITS THE PLASTIC BODY AT THE BOTTOM OF THE PARTING LINE.
- DATUMS -A-, -B- AND -D- TO BE DETERMINED AT DATUM PLANE -H-.
- DIMENSIONS D AND E TO BE DETERMINED AT SEATING PLANE -C-.
- DIMENSIONS D1 AND E1 DO NOT INCLUDE MOLD PROTRUSION. ALLOWABLE PROTRUSION IS 0.25 (0.010) PER SIDE. DIMENSIONS D1 AND B1 DO INCLUDE MOLD MISMATCH AND ARE DETERMINED AT DATUM PLANE -H-.
- DIMENSION b DOES NOT INCLUDE DAMBAR PROTRUSION. DAMBAR PROTRUSION SHALL NOT CAUSE THE b DIMENSION TO EXCEED 0.45 (0.018).

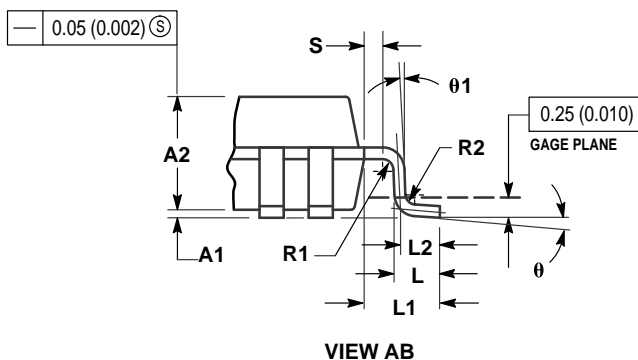
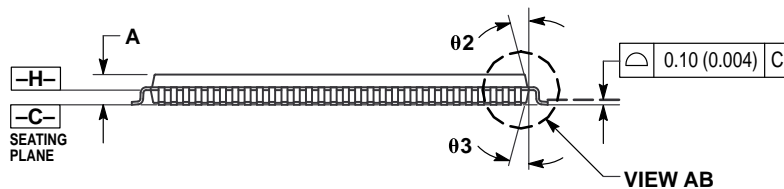

DIM	MILLIMETERS		INCHES	
	MIN	MAX	MIN	MAX
A	—	1.60	—	0.063
A1	0.05	0.15	0.002	0.006
A2	1.35	1.45	0.053	0.057
b	0.22	0.38	0.009	0.015
b1	0.22	0.33	0.009	0.013
c	0.09	0.20	0.004	0.008
c1	0.09	0.16	0.004	0.006
D	22.00 BSC		0.866 BSC	
D1	20.00 BSC		0.787 BSC	
E	16.00 BSC		0.630 BSC	
E1	14.00 BSC		0.551 BSC	
e	0.65 BSC		0.026 BSC	
L	0.45	0.75	0.018	0.030
L1	1.00 REF		0.039 REF	
L2	0.50 REF		0.020 REF	
S	0.20	—	0.008	—
R1	0.08	—	0.003	—
R2	0.08	0.20	0.003	0.008
theta	0°	7°	0°	7°
theta 1	0°	—	0°	—
theta 2	11°	13°	11°	13°
theta 3	11°	13°	11°	13°

Mfax is a trademark of Motorola, Inc.

### How to reach us:

USA/EUROPE/Locations Not Listed: Motorola Literature Distribution;  
P.O. Box 5405, Denver, Colorado, 80217. 1-303-675-2140 or 1-800-441-2447

Mfax™: RMFAX0@email.sps.mot.com – TOUCHTONE 1-602-244-6609  
Motorola Fax Back System – US & Canada ONLY 1-800-774-1848  
– http://sps.motorola.com/mfax/

HOME PAGE : <http://motorola.com/sps/>

JAPAN: Nippon Motorola Ltd.: SPD, Strategic Planning Office, 141,  
4-32-1 Nishi-Gotanda, Shagawa-ku, Tokyo, Japan. 03-5487-8488

ASIA/PACIFIC: Motorola Semiconductors H.K. Ltd.; 8B Tai Ping Industrial Park,  
51 Ting Kok Road, Tai Po, N.T., Hong Kong. 852-26629298

CUSTOMER FOCUS CENTER: 1-800-521-6274



MCM69F536C/D