

**EPM 32 ELECTRONIC PROGRAM MEMORY  
FOR 32 STATIONS**

- ONE CHIP INCLUDING CONTROL AND NV MEMORY
- SUPPLY VOLTAGE  $V_{DD} = 5 V \pm 5\%$   $V_{PP} = 25 V \pm 1 V$  (only for storage and reading)
- AUTOMATIC, SEMIAUTOMATIC AND MANUAL SEARCH MODES
- MANUAL SEARCH CONTROLLED BY ONLY TWO KEYS (up and down). THE SEARCH SPEED IS AUTOMATICALLY INCREASED SMOOTHLY WITH THE TIME
- 4 BAND OUTPUTS WITH STEP-BY-STEP SELECTION AND THE POSSIBILITY OF SKIPPING UNWANTED BANDS
- MEMORY ADDRESSING AND COPY CAPABILITY
- EXTERNALLY ADJUSTABLE SEARCH SPEED
- 445 TO 510 kHz CLOCK OSCILLATOR
- VOLTAGE SYNTHESIZER, 8192 STEP RESOLUTION
- FINE TUNING IN 8 STEPS, STORABLE FOR EACH PROGRAM SEPARATELY
- MINIMUM EXTERNAL COMPONENTS
- INTEGRATED DIGITAL POWER-ON RESET (1 second)
- TECHNICAL NOTE TN 153 AVAILABLE

semiautomatic or manual modes. The search speed is controlled externally by an RC network and is adapted internally to the various bands and mode of operation. In the automatic mode the M293 works in conjunction with the TDA4433, which recognizes TV stations and converts the AFC-S-curve into a digital command. The stations are selected by applying a static bit binary word. A strobe input is also provide. A 7 segment decoder-driver (e.g. TDA4092) can be connected to the same lines for Program number display.

A serial information output is provided so that using the M191, the varicap voltage in the form of a linear bar and the selected band can be displayed on the screen.

The M293 is available in a 28 lead dual in-line plastic package.

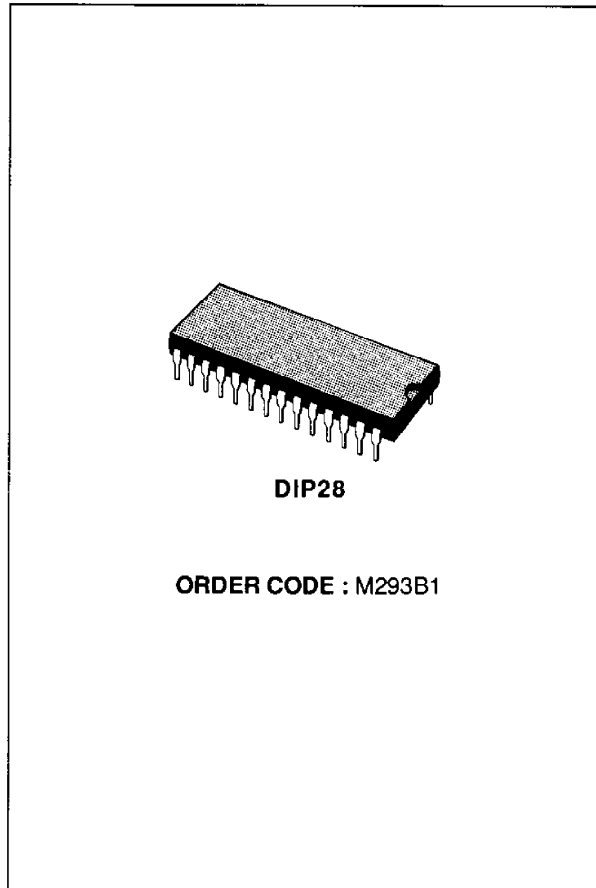

**DESCRIPTION**

The M293 is a monolithic integrated circuit constructed in N-channel silicon gate technology, designed to control a varicap tuner with a resolution of 8192 steps (13 bits) via a D/A converter, using the principle of voltage synthesis.

The device also includes a 544 bit NV Memory for storage of 32 stations. Each station is identified by a 17 bit word containing the information for tuning voltage (12 bits), band (2 bits) and fine tuning (3 bits). The circuit is able to operate in automatic,

## ABSOLUTE MAXIMUM RATINGS

Symbol	Parameter	Value	Unit
V <sub>DD</sub>	Supply Voltage	- 0.3 to 7	V
V <sub>PP</sub>	Memory Supply Voltage	- 0.3 to 28	V
V <sub>I</sub>	Input Voltage	- 0.3 to 15	V
V <sub>O (off)</sub>	Off State Input Voltage (except pin 10)	15	V
	Pin 10	28	V
I <sub>OL</sub>	Output Current (except pins 11 - 19)	5	mA
	Pins 11 - 19	7.5	mA
I <sub>OH</sub>	Output Current (pin 2)	- 2	mA
P <sub>tot</sub>	Total Package Power Dissipation	1	W
T <sub>stg</sub>	Storage Temperature	- 25 to 125	°C
T <sub>op</sub>	Operating Temperature	0 to 70	°C

Stresses above those listed under "Absolute Maximum Ratings" may cause permanent damage to the device. This is a stress rating only and functional operation of the device at these or any other conditions above those indicated in the operational sections of this specification is not implied. Exposure to absolute maximum rating conditions for extended periods may affect device reliability.

## PIN CONNECTIONS

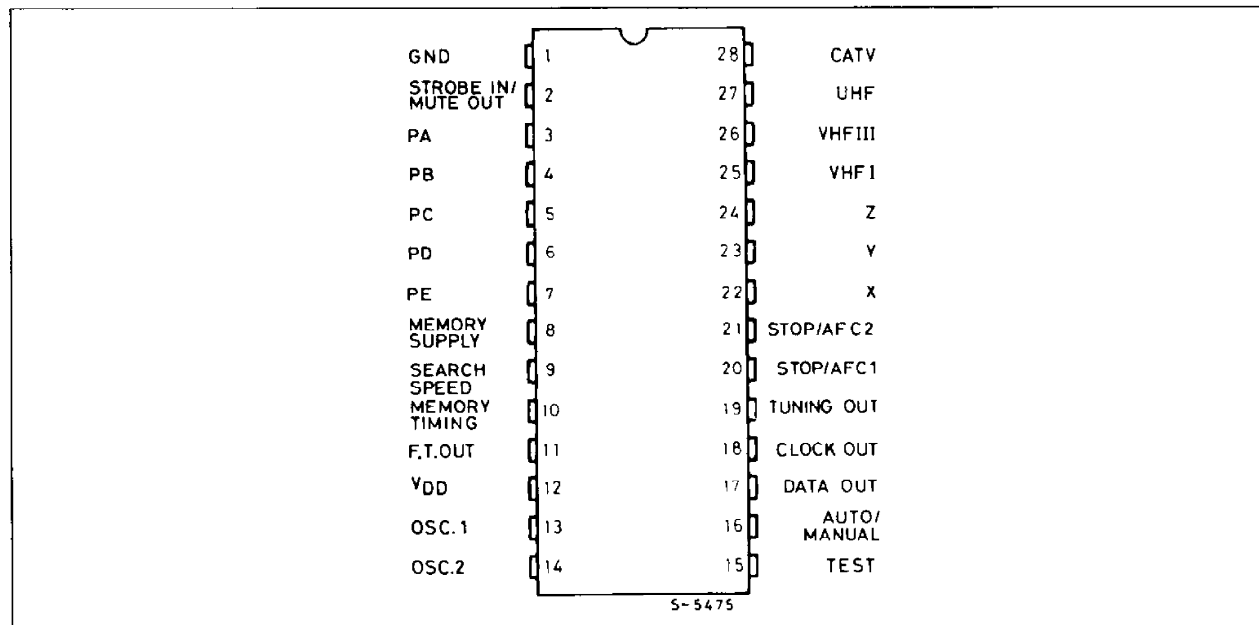

## RECOMMENDED OPERATING CONDITIONS

Symbol	Parameter	Value	Unit
$V_{DD}$	Supply Voltage	4.75 to 5.25	V
$V_{PP}$	Memory Supply Voltage	24 to 26	V
$V_I$	Input Voltage	0 to 13.2	V
$V_{O(off)}$	Off State Input Voltage (except pin 10) Pin 10	Max. 13.2 Max. 26	V V
$I_{OL}$	Output Current (except pins 11 – 19) Pins 11 – 19	Max. 2.5 Max. 5	mA mA
$I_{OH}$	Output Current (pin 2)	Max. -0.25	mA
$t_{pd}$	Delay between Memory Timing and Memory Supply Pulses	Max. 5	$\mu$ s
f	Clock Frequency	500	kHz
$T_{op}$	Operating Temperature	0 to 70	$^{\circ}$ C
R9	Search Speed Resistance (pin 9)	18 to 330	K $\Omega$
C9	Search Speed Capacitance (pin 9)	Max. 100	nF
$t_d$	Delay of $V_{PP}$ from $V_{DD}$ at Power-on	Max. 1	sec.
$t_r$	Rise Time of $V_{PP}$ (during storage or reading)	2 to 10	$\mu$ s
$r_s$	Serial Resistance of the Ceramic Resonator	Max. 20	$\Omega$

## BLOCK DIAGRAM

Figure 1.

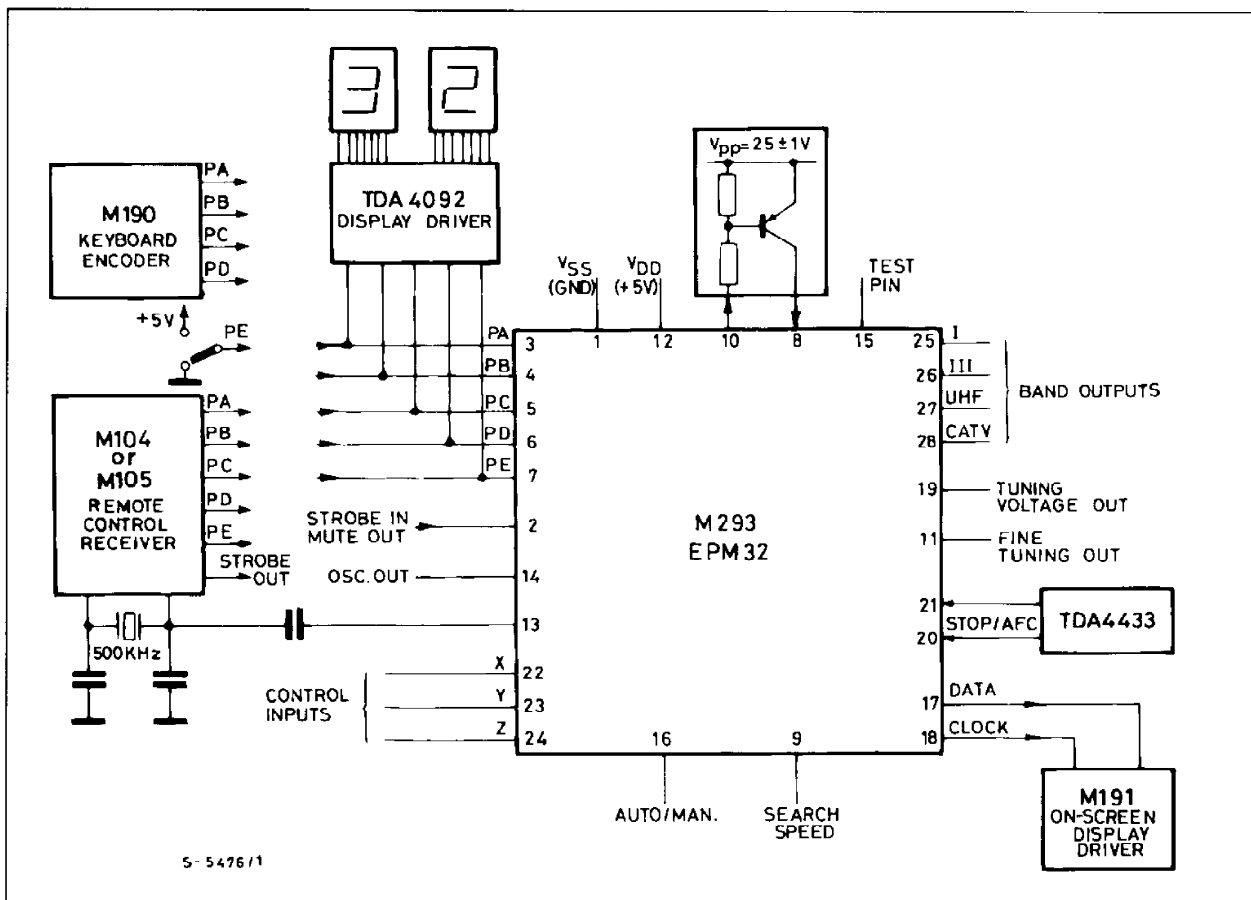

**STATIC ELECTRICAL CHARACTERISTICS** (over recommended operating conditions)Typical Values are at 5 V and  $T_{amb} = 25\text{ }^{\circ}\text{C}$ 

Symbol	Parameter	Pins	Test Conditions	Value			Unit	
				Min.	Typ.	Max.		
$V_{IL}$	Input Low Voltage	2-3-4-5-6-7				0.8	V	
		25-26-27-28				0.3		
		16-20-21-22 23-24				1.5		
$V_{IH}$	Input High Voltage	2-3-5-6-7				2	V	
		25-26-27-28				3		
		16-20-21-22 23-24				3.5		
$V_{OL}$	Output Low Voltage	25-26-27-28	$V_{DD} = 4.75\text{ V } I_{OL} = 1\text{ mA}$			3	V	
		11-19	$V_{DD} = 4.75\text{ V } I_{OL} = 5\text{ mA}$			1		
		2-7-18	$V_{DD} = 4.75\text{ V } I_{OL} = 100\text{ }\mu\text{A}$			0.4		
		10	$V_{DD} = 4.75\text{ V } I_{OL} = 5\text{ mA}$			8		
$V_{OH}$	Output High Voltage	2	$V_{DD} = 4.75\text{ V } I_{OH} = -0.25\text{ mA}$			2.4	V	
		17-18	$V_{DD} = 4.75\text{ V } I_{OH} = -0.15\text{ mA}$			2.4		
$I_{O(off)}$	Output Leakage Current	25-26-27-28	$V_{DD} = 5.25\text{ V } V_{O(off)} = 13.2\text{ V}$			100	$\mu\text{A}$	
		11-19	$V_{DD} = 5.25\text{ V } V_{O(off)} = 13.2\text{ V}$			50		
		10	$V_{DD} = 4.75\text{ V } V_{O(off)} = 26\text{ V}$			100		
$I_{IL}$	Input Low Current	3-4-5-6-7 16-22-23-24	$V_{DD} = 5.25\text{ V } V_{IL} = 0.8\text{ V}$			-0.4	mA	
		20-21	$V_{DD} = 5.25\text{ V } V_{IL} = 1.5\text{ V}$			-0.4		
		2	$V_{DD} = 5.25\text{ V } V_{IL} = 0.4\text{ V}$			-1.6		
$I_{DD}$	Supply Current	12	$V_{DD} = 5.25\text{ V}$		20	50	mA	
$I_{PP}$	Memory Supply Current	8	$V_{PP} = 26\text{ V}$	Write	Peak		40	mA
					Average		11	
				Erase	Peak		7	
					Average		4.5	
				Read	Peak		6	
					Average		2	

**DESCRIPTION** (all timings are given with  $f_{ref} = 500\text{ kHz}$ )

The circuit description follows both pin sequence and pin function.

**PIN 1.  $V_{SS}$** 

The substrate of the integrated circuit is connected to this pin.

**PIN 2. PROGRAM STROBE INPUT/MUTE INPUT**

**PROGRAM STROBE INPUT.** Although the program change is internally detected and the M293

can also work with Remote Control receivers without any strobe output, the strobe function is useful, for example, to recall the stored tuning voltage after a search.

This input is active low and has an internal pull-up to 6 K (typ).

A second mute cycle restarts when the input goes low and the memory is read after 110 ms.

Figure 2.

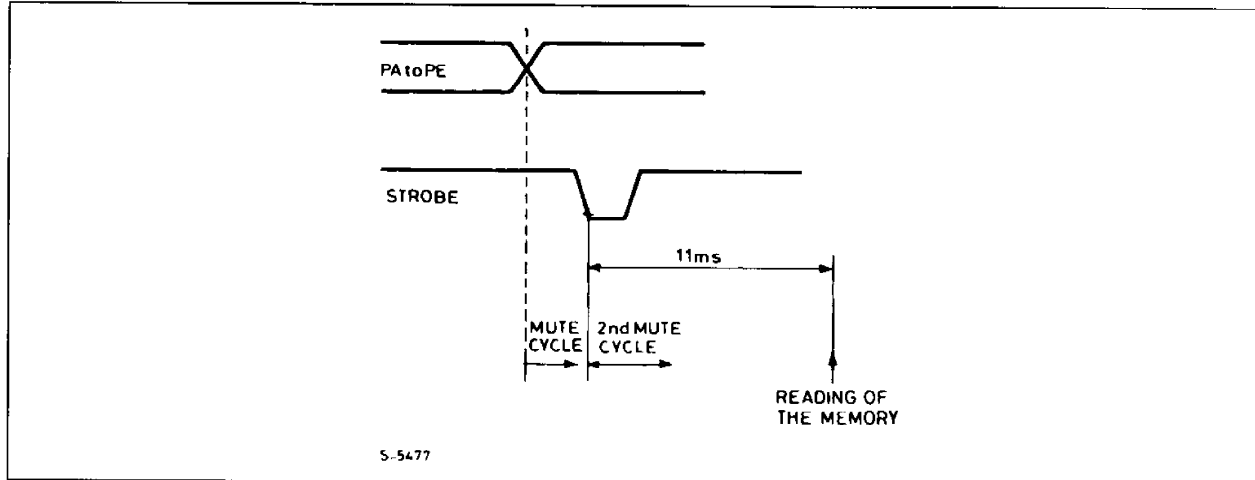

**MUTE OUTPUT.** The output transistor is switched on when the Mute function is activated.

The Mute is present in the following cases :

- at band change
  - at program change
  - during automatic search
- } The mute is active 110 ms before the execution of the command and lasts 480 ms

The Mute is active 110 ms before the start of the search

- when the supply voltage VDD is applied, for about 1 second
- when the supply voltage VDD is removed.

Figure 3.

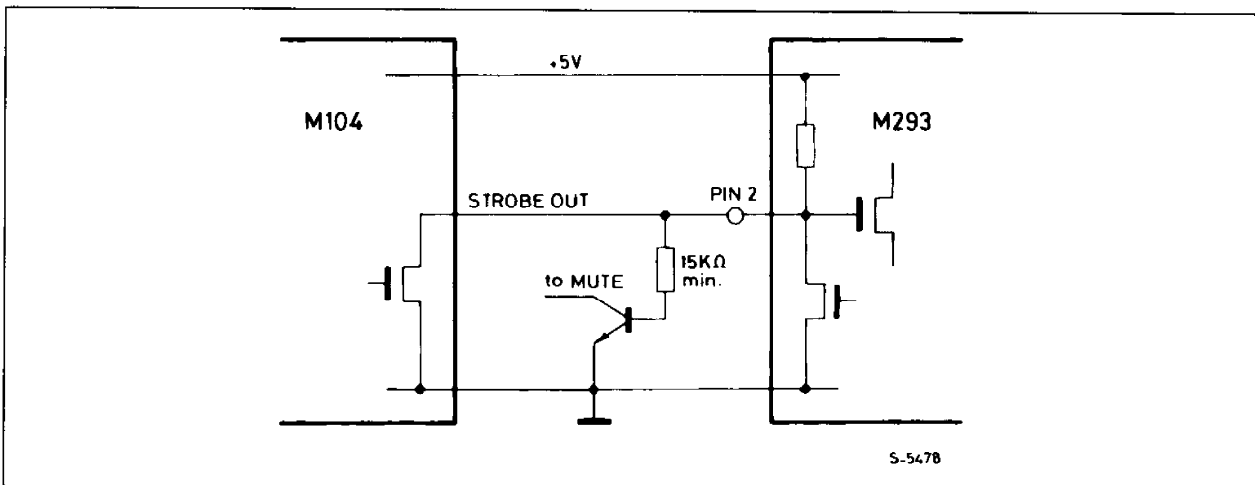

### PIN 3-4-5-6-7. PROGRAM SELECTION INPUTS

The programs are selected with a static 5 bit word according to the truth table given below. Input levels are TTL compatible. The inputs have an internal

pull-up of 30 K (typ.). The memory is read with a delay of 110 ms, after the strobe command or the program change.

Program	PA	PB	PC	PD	PE	Program	PA	PB	PC	PD	PE
1	L	L	L	L	L	17	L	L	L	L	H
2	H	L	L	L	L	18	H	L	L	L	H
3	L	H	L	L	L	19	L	H	L	L	H
4	H	H	L	L	L	20	H	H	L	L	H
5	L	L	H	L	L	21	L	L	H	L	H
6	H	L	H	L	L	22	H	L	H	L	H
7	L	H	H	L	L	23	L	H	H	L	H
8	H	H	H	L	L	24	H	H	H	L	H
9	L	L	L	H	L	25	L	L	L	H	H
10	H	L	L	H	L	26	H	L	L	H	H
11	L	H	L	H	L	27	L	H	L	H	H
12	H	H	L	H	L	28	H	H	L	H	H
13	L	L	H	H	L	29	L	L	H	H	H
14	H	L	H	H	L	30	H	L	H	H	H
15	L	H	H	H	L	31	L	H	H	H	H
16	H	H	H	H	L	32	H	H	H	H	H

**PIN 8. MEMORY SUPPLY VOLTAGE**

A supply voltage of  $25 \pm 1$  V has to be applied to this pin during the modify and read cycles.

**MODIFY CYCLE**

A modify cycle consists of three steps :

1. All "1"s are written in the bits of the selected word.
2. All bits of the selected word are erased (all "0"s).
3. The new content is written.

In this way a constant aging of all the bits of the word is obtained.

During both write and erase cycles the memory situation is checked continuously ; therefore after each write or erase pulse a read operation is carried out. The write or the erase operations are stopped as soon as the result of the read operation is valid.

**WRITE CYCLE.** The peak of the current flowing through pin 8 during a write operation is shown in fig. 4, while fig. 5 shows the envelope of the same current.

The typical write time is 3-4 ms for the first cycles and increase to about 30 ms after 1000 cycles.

**Figure 4.**

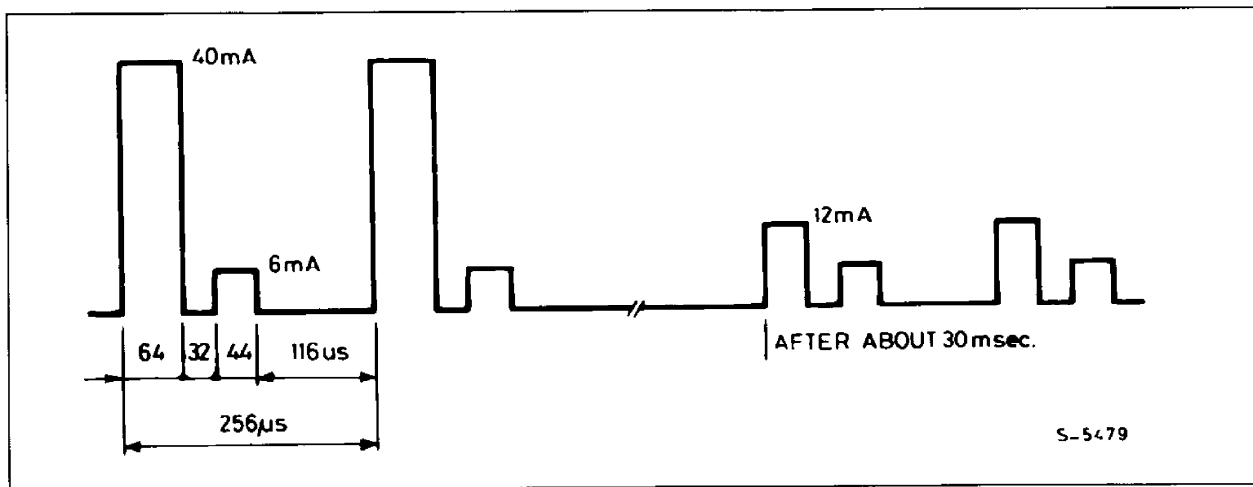
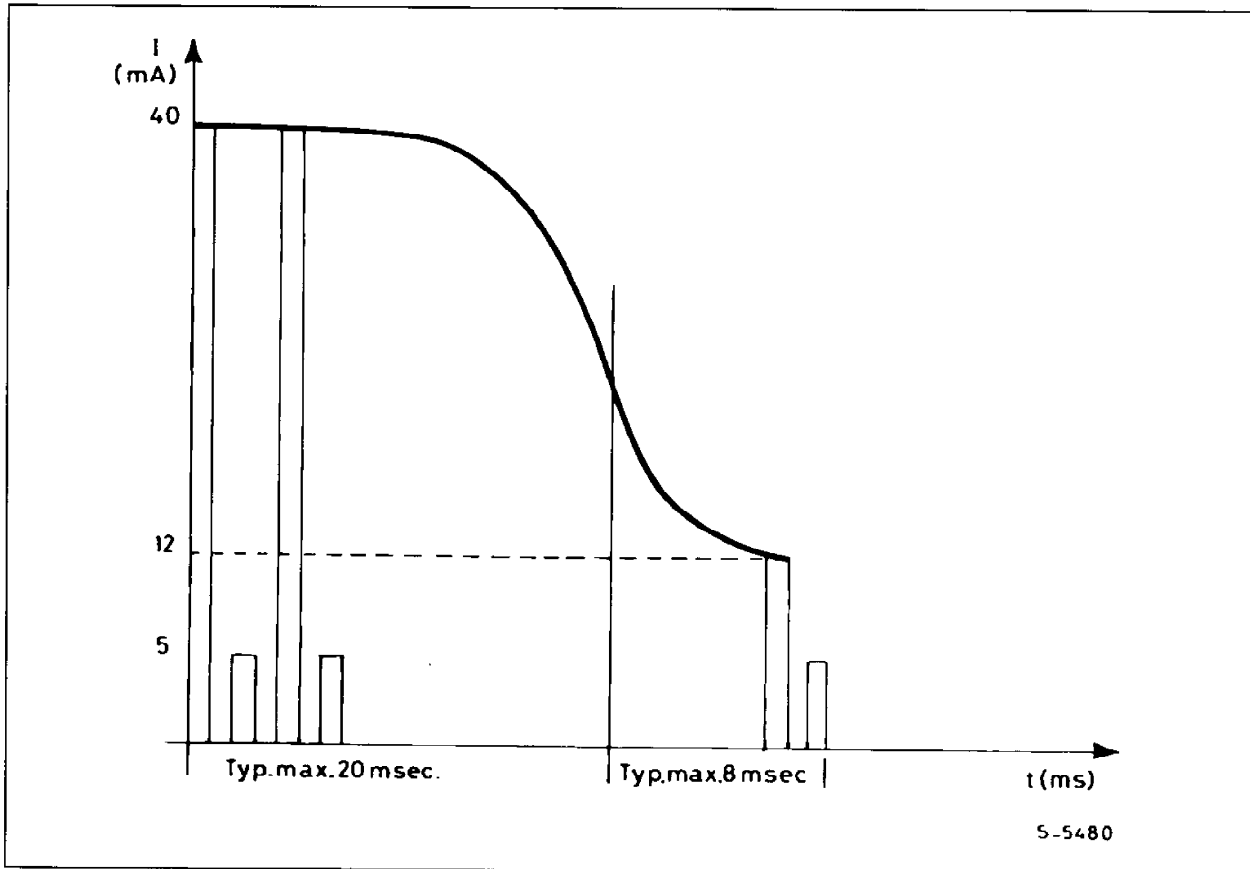

Figure 5.



ERASE CYCLE. Fig. 6 shows the timing and the waveform of the current flowing through pin 8 during the erase operation.

The peak current is 7 mA (max) during the erase cycle and 6 mA (max) during the read cycle. The

typical erase time is 10 ms for a new device and it increases with the number of modify operations up to 200 ms after 1000 cycles.

Figure 6.

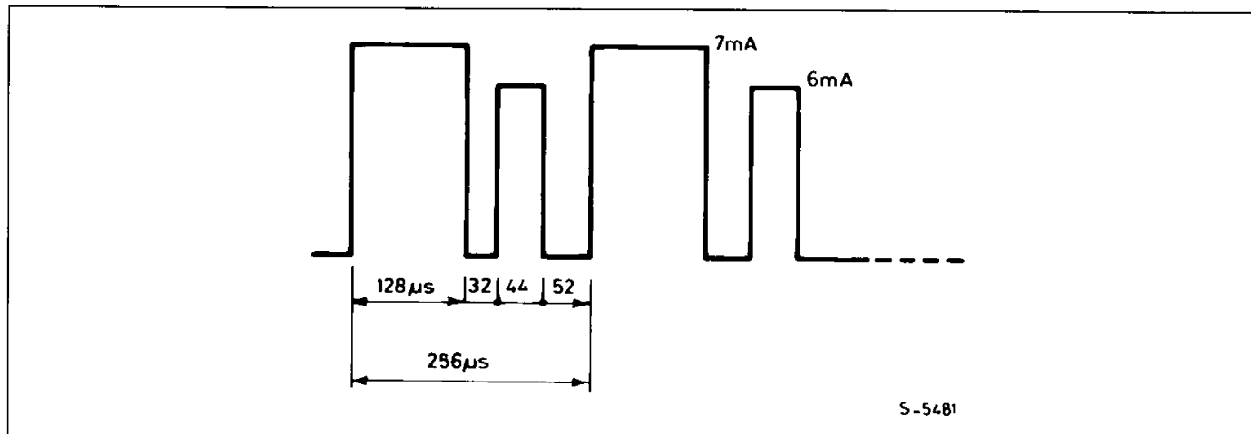

In order to protect the memory in case of failure of some bits the modify operation is stopped after 1 sec.

READ CYCLE

Fig. 7 shows the waveform of the current during a read operation.

Figure 7.

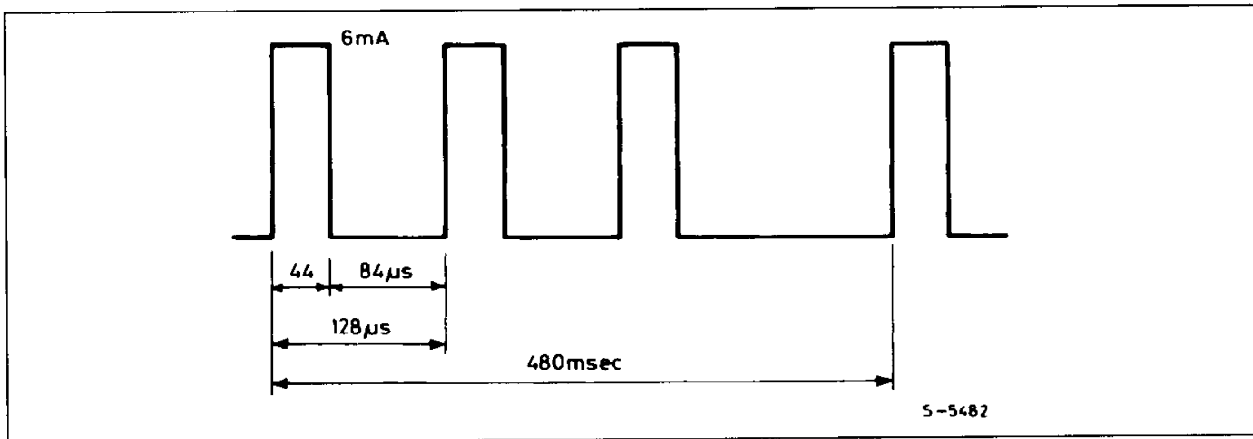

PIN 9. SEARCH SPEED

An external RC network is connected to this pin in order to set the frequency of the internal oscillator which, in turn, sets the scan speed during search.

The search speed ratios in the bands are explained in the description of pins 22, 23, 24 (UP/DOWN Manual) and of pins 20 and 21.

PIN 11. FINE TUNING OUT

Fine tuning information is available on this pin in the form of a square wave having a frequency of 15.625 Hz and duty cycle variable in 8 positions as indicated in fig. 8.

PIN 10. MEMORY TIMING OUTPUT

This output gives the timing for the pulses to be applied at pin 8 during the modify and read cycles. The output consists of an open drain transistor.

Figure 8.

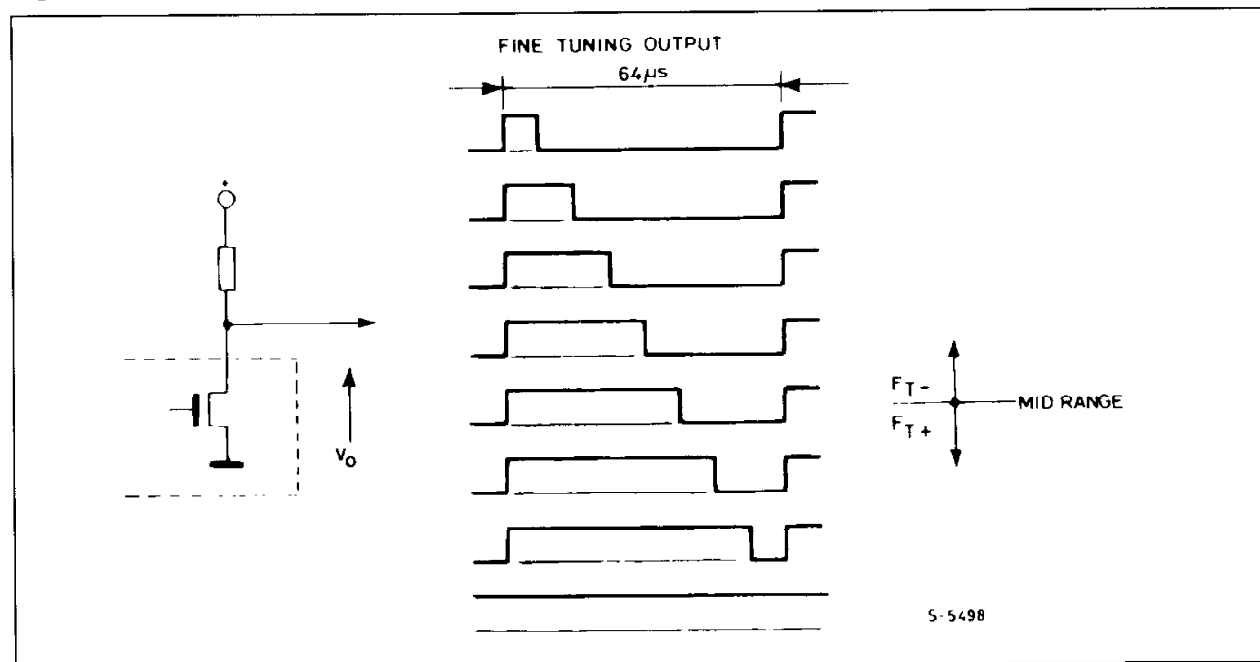



The voltage generated after filtering is fed to the AFC loop and detunes the receiver by a small  $\Delta f$  while maintaining the action of the AFC.

The Fine tuning function operates as follows :

- At the start of the search (Auto or Manual) the output is set at mid range (see fig. 8).
- When the search has been completed it is possible to operate on the FINE TUNING  $\pm$  commands.

The STORE command memorizes this information together with the 12 tuning voltage and 2 bit band information.

- When a memorized channel is recalled it is possible to act on the FINE TUNING  $\pm$  commands.

Any change in Fine tuning is memorized only by the STORE command. The output circuit consists of an open drain transistor.

Figure 9.

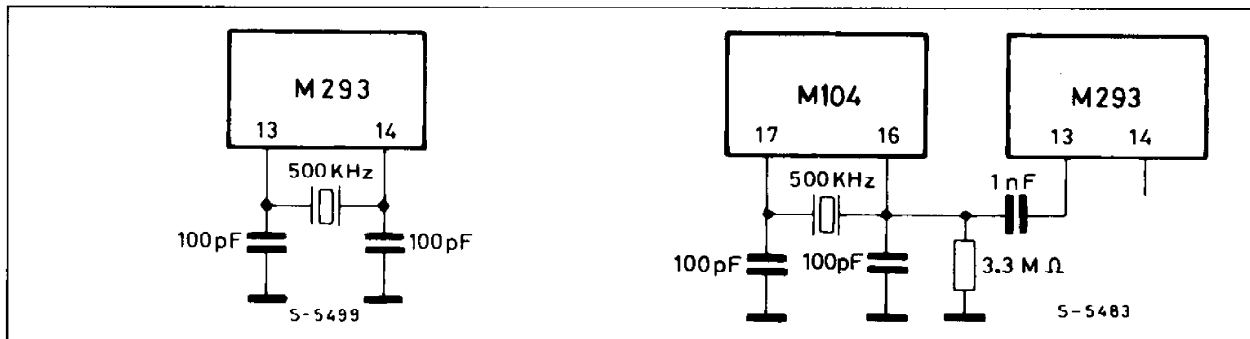

#### PIN 16. AUTOMATIC/MANUAL SEARCH MODE SELECTION

This pin is used to change the search mode. When it is connected to  $V_{DD}$  the system works in Automatic mode ; when it is connected to  $V_{SS}$  the system works manually.

The change Auto-Manual or viceversa can be made at any time without affecting other circuit functions.

The input has an integrated pull-up of 30 K $\Omega$  (typ.).

#### PIN 17. DATA OUTPUT FOR EXTERNAL DISPLAY (M191)

A 16 bit burst is available on this pin. It contains the 8 MSB of the digitized tuning voltage, 2 bits for band

#### PIN 12. $V_{DD}$

This pin has to be connected to a 5 V  $\pm$  0.25 V supply.

When the  $V_{DD}$  is applied to this pin an internal power on reset of 1 sec is generated : therefore, for a correct reading of the memory, the  $V_{PP}$  supply voltage must reach the value of 25 V within 1 sec after the presence of  $V_{DD}$ .

#### PIN 13-14. OSCILLATOR

The internal oscillator operates with a cheap 445 to 510 kHz ceramic resonator connected as shown in fig. 9.

If an external oscillator is used, the signal to be applied must be 0.5  $V_{PP}$  min.

information, 5 bits for program information and 1 bit which indicates that the system is in the search mode (both Automatic or Manual). The display is also enabled at the band change.

These outputs are active low and incorporate a 10 K $\Omega$  (typ) pull-up resistors.

#### PIN 18. CLOCK OUTPUT FOR EXTERNAL DISPLAY (M191)

A burst containing 16 clock pulses is available on this pin. This clock pulses are synchronized with Data Information as described in fig. 10.

A pull-up of 10 K $\Omega$  (typ) is integrated.

Figure 10.

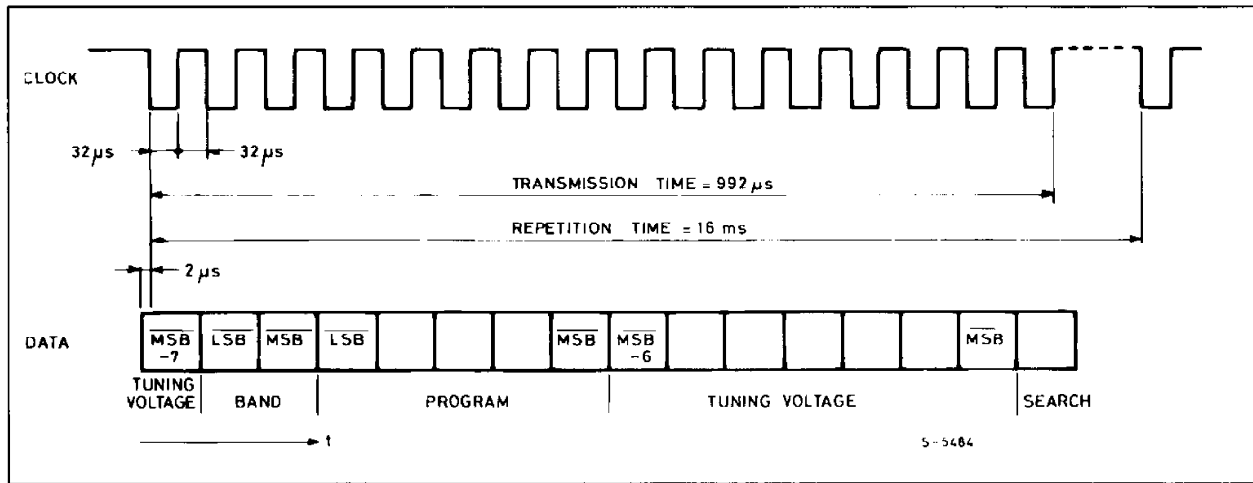

**PIN 19. TUNING VOLTAGE OUT**

A  $2^{13} = 8192$  step pulse modulated signal for the tuning voltage is available on this pin.

Pulse modulation is implemented by combination of a rate multiplier and pulse width principle.

With a tuning voltage increasing from zero, the number of pulses increases continuously up to  $2^8 = 256$  ;

starting from this point the number of pulses remains the same but the pulses get larger until they reach the maximum content of the internal counter. The output consists of an open drain transistor which offers a low impedance to ground when in the ON state.

Figure 11.

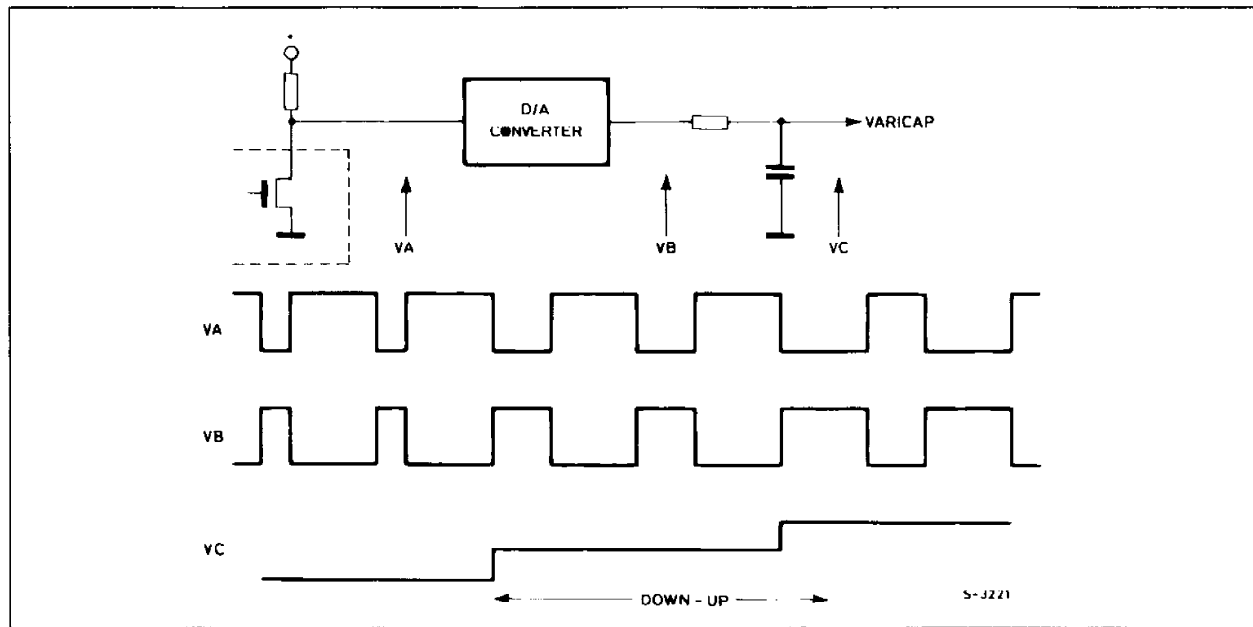

## PIN 20-21. STOP/AFC

These pins are used only in automatic search mode.

When the M293 is in manual operation these pins are disabled internally.

The STOP/AFC inputs are also disabled internally during any program or band change for the duration of the Mute signal.

These pins work according to the truth table given below :

M293 Pin 20 TDA4433 Pin 2	M293 Pin 21 TDA4433 Pin 6	Function (referred to tuning voltage)
H	L	Up
L	H	Down
L	L	Middle
H	H	No Operation

These inputs have two different functions depending on whether the system is in the search or in normal operation (AFC control).

The inputs have internal pull-up resistors of 30 K $\Omega$  typ. (10 K $\Omega$  min).

A) **Search mode** : after depressing the Search start key, the levels of the signals coming from the TDA4433, applied to these pins, control the search function and determine when the search must stop, i.e. a TV station has been recognized. The circuit operates in the following sequence (see fig. 12 for reference and explanation of pins 22, 23, 24 for definition) :

- 1 - after pressing the search start key the search occurs in the FAST UP mode.
- 2 - eventual transitions available on these inputs are ignored during the first 15 search steps if the system is in the UHF or CATV bands.

If the system operates in VHF I and III the first 60 search steps are ignored. The acceptance delay of 15 (60) search steps has been introduced to prevent the system from stopping at the previous station (for example if the search start command

has been given just before an AFC control command).

After this time the FAST UP speed is automatically reduced to half during each UP signal (MEDIUM UP = FAST UP/2).

A DOWN signal preceded by at least an UP signal will set the search to MEDIUM DOWN mode (FAST UP/4).

3 - the next UP signal will switch the search to SLOW UP speed (61 Hz).

At this point the system is in normal AFC operation.

B) **AFC operation** : when a station is perfectly tuned, the input signals coming from TDA4433 are at tuning condition.

If the tuning moves lower than the threshold below 38.9 MHz, the pin 20 is put H and pin 21 is put L ; the 13 bit internal counter is moved with SLOW UP speed to increase the varicap voltage. When a detuning occurs in the opposite direction the input 20 goes low and 21 goes high and the tuning voltage is decreased with VERY SLOW DOWN speed (7.6 Hz).

The increase or decrease of the tuning voltage is stopped as soon as the input returns to middle conditions.

Therefore during normal operation pins 20 and 21 act as the AFC control command.

C) **Recall from memory** : when the circuit is in automatic mode and a pre-memorized program is recalled from Memory, a fixed value of 8 steps (~ 31.2 mV) is subtracted from the tuning voltage. This corresponds to a detuning of 0.6 MHz (UHF) and of 0.3 MHz in VHF III into that part of the IF response curve which corresponds to the fully transmitted sideband.

At this point the AFC operation takes over as described in point B above and the exact tuning is achieved in about 0.2 sec.

This feature increases the AFC capture range and relaxes the stability requirements of the tuner, voltage references and the D/A converter.

Figure 12.

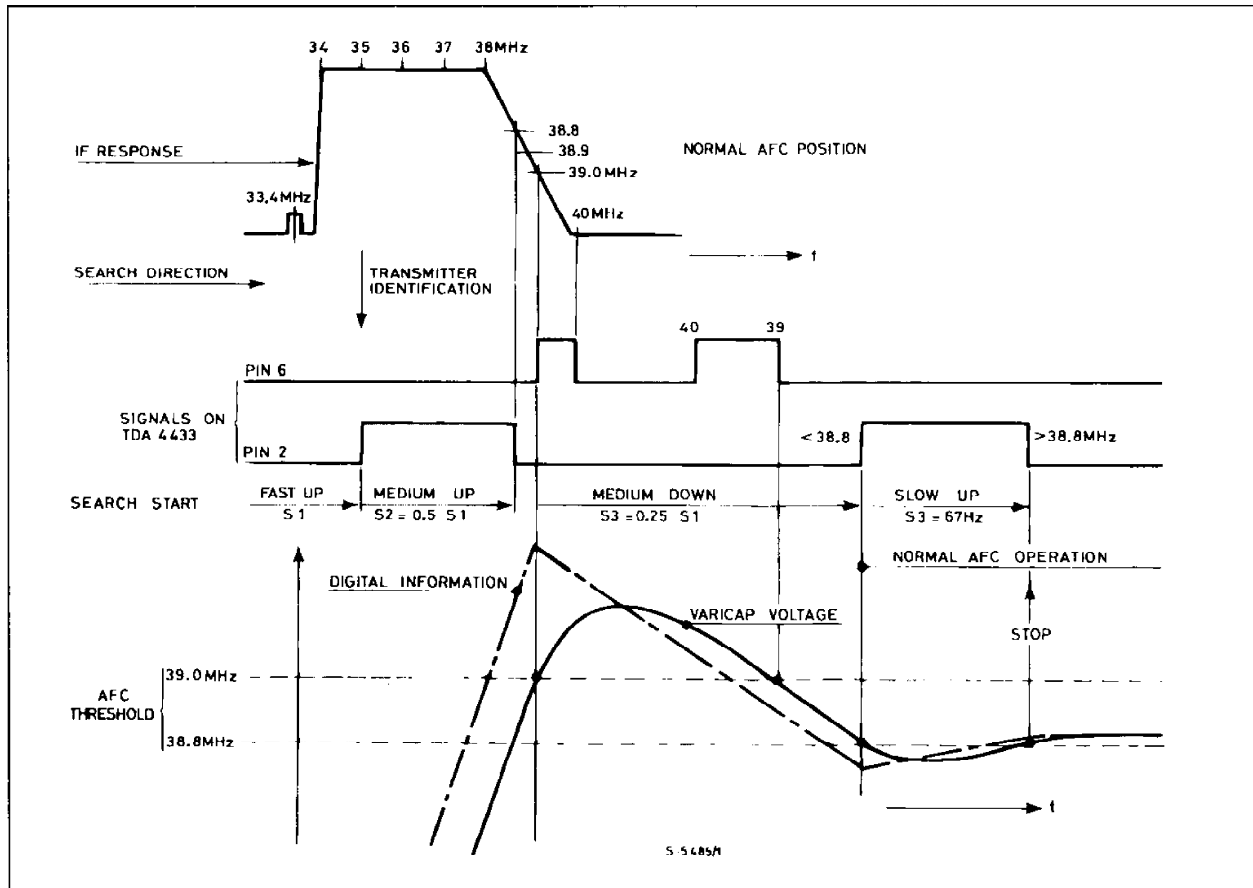

PINS 22-23-24 CONTROL INPUTS X - Y - Z

The M293 accepts binary coded commands as follows :

X	Y	Z	Function
H	H	H	-----
L	H	H	Memory Addressing/Store
H	L	H	Band Selection
H	H	L	Manual Mode (pin 16 L) { Up Down Automatic Mode (pin 16 H) { FT+ FT-
L	L	H	
H	L	L	Automatic Search Start (without band change)
L	H	L	Automatic Search Start (with band change)

The inputs have integrated pull-up resistors of 30 KΩ (typ). Commands are accepted after 30 ms of continuous presence. A new command is not accepted until the previous one has been released.

Figure 13.

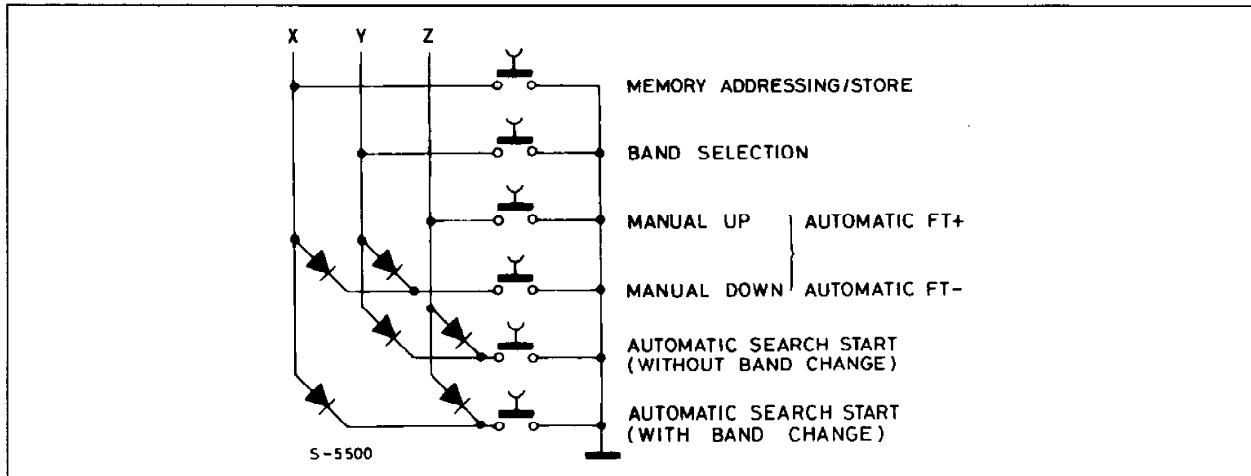

**MEMORY ADDRESSING/STORE.** The normal sequence of program storage (program selection, search, store, new program selection and so on) can be changed in order to have the possibility to select the memory position (program number) after the search.

In this way the search is faster and continuous through the bands.

When the key is pressed it is possible to select the memory position. When the key is released the store function is activated (with 30 ms of acceptance time).

The proposed sequence of tuning and storage is as described below :

Step	Operation
1	Tune in station (manually or automatically)
2	Press "Memory addressing/Store" key and hold it pressed
3	Select the program where the tuning is to be stored
4	Release the "Memory addressing/Store" key At this moment 12 bits of the digitized tuning voltage, 2 bits for band 3 bits relative to Fine Tuning are stored

If this solution for memory addressing/store is not used, memorization will occur at the release of the key in the memory position previously selected.

This command is disabled during the Automatic search, During the store cycle any other operation is blocked. Only the program change command is stored internally and executed when the store cycle is over.

In order to protect the memory the store function is disabled internally after one store cycle. It is enabled after a program change or a tuning operation (it is not disabled by the AFC control).

**BAND SELECTION.** The bands can be step-by-step selected with the following sequence :

Band	Data Bus	
	MSB	LSB
VHF III	L	L
UHF	L	H
VHF I	H	L
CATV	H	H

Only one band change is performed at each accepted command.

Disabled bands are automatically skipped. A band can be disabled by connecting the corresponding output to VSS.

**MANUAL MODE UP/DOWN, AUTOMATIC MODE FT+/FT-.** The function of this pin depends on the search mode that is determined by pin 11.

**Manual :** when a command is accepted the search begins at low speed. One second later, the search speed is increased and it reaches the maximum value after 3 seconds.

Search	speed Time
÷ 8	Command accepted
÷ 4	After 1 second
÷ 2	After 2 seconds
÷ 1	After 3 seconds

The search is correlated to the selected band as follows :

Max search speeds :

- Bands VHF I and VHF III : external rate divided by 3
- Bands UHF and CATV : external rate divided by 12

When the end of the band is reached the search restarts from the beginning of the same band after a delay of 480 ms.

Figure 14.

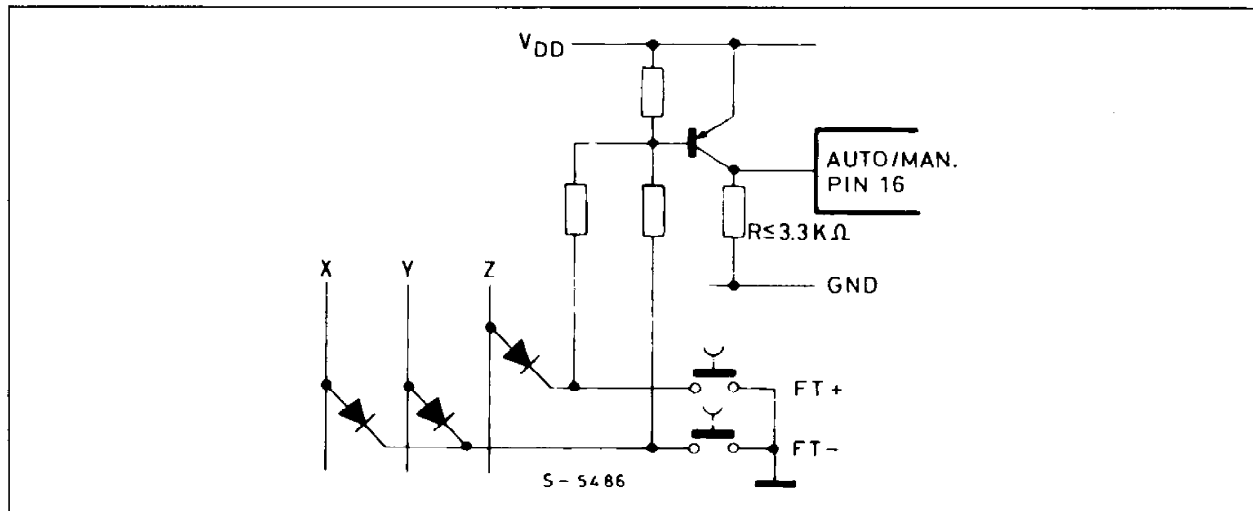

**Automatic fine tuning +/-** : when the command is accepted, the PWM signal present at the fine tuning output (pin 11) is changed at the rate of one step every 480 ms.

Fine tuning in manual mode is possible switching temporarily the system to automatic modes as shown in fig. 14.

**AUTOMATIC SEARCH (without band change).** When the command is accepted the search starts on the selected band. When the end of the band is reached the search restarts from the beginning of the same band after a delay of 480 ms.

If the key is held depressed another search can start only if the key is released and connected again to VSS.

During the search the tuning voltage is always changing from lower to higher voltage levels. The search is automatically stopped when the first station is found.

The search is also stopped whenever a program selection command is given.

The search speed is determined by the RC network connected to pin 17 and is correlated to the band. UHF and CATV bands are scanned with the rate fixed externally divided by 4.

VHF bands are scanned with the rate fixed externally.

During the STOP sequence the search speed is automatically reduced as defined in the explanation of pins 20 and 21.

**AUTOMATIC SEARCH (with band change).** The search is effected starting from the tuning position.

When the end of band is reached, the band is automatically changed in the sequence described at pins 22-23-24 (Band selection command). Disabled bands are automatically skipped.

#### PINS 25-26-27. BAND OUTPUTS/INPUTS

These outputs are provided to select up to 4 bands via external PNP's.

If one or more bands have to be skipped, the corresponding outputs have to be short-circuited to V<sub>SS</sub>.

Figure 15.

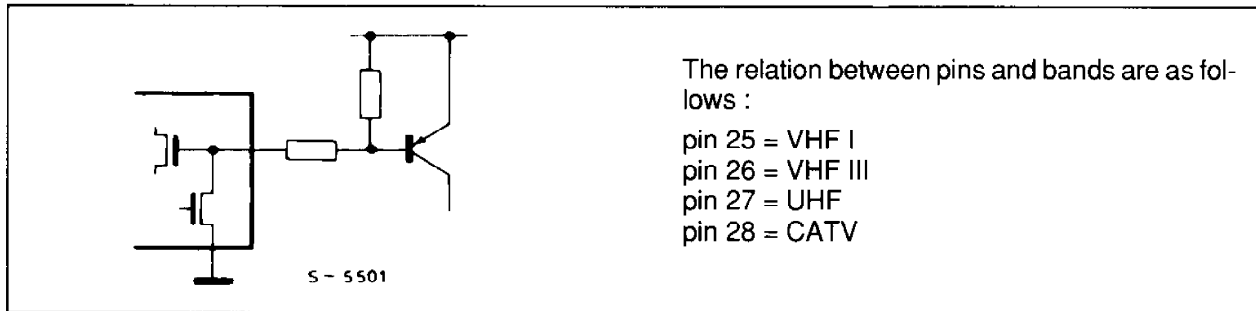

TYPICAL APPLICATIONS

Automatic Version.

