

XC6201

Series

Positive Voltage Regulators



- ◆ CMOS Low Power Consumption
- ◆ Dropout Voltage : 0.16V @ 100mA,
0.40V @ 200mA
- ◆ Maximum Output Current : 250mA (V_{OUT}=5.0V, TYP)
- ◆ Highly Accurate : ± 2%
- ◆ Output Voltage Range : 1.3V ~ 6.0V
- ◆ SOT-25 / SOT-89 / TO-92 Package
- ◆ Capacitors can be Tantalum or Ceramic

Applications

- Mobile phones
- Cordless phones
- Cameras, video recorders
- Portable games
- Portable AV equipment
- Reference voltage
- Battery powered equipment

3

General Description

The XC6201 series are highly precise, low power consumption, positive voltage regulators manufactured using CMOS and laser trimming technologies.

The series provides large currents with a significantly small dropout voltage.

The XC6201 consists of a current limiter circuit, a driver transistor, a precision reference voltage and an error amplifier. Output voltage is selectable in 0.1V steps between 1.3V ~ 6.0V.

SOT-25 (250mW), SOT-89 (500mW) and TO-92 (300mW) packages are available.

Features

- Maximum Output Current : 250mA (TYP.)
- Dropout Voltage : 0.16V @ 100mA
- Maximum Operating Voltage : 10V
- Output Voltage Range : 1.3V ~ 6.0V
(selectable in 0.1V steps)
- Highly Accurate : ± 2%
- Low Power Consumption : TYP 2.0 μA
- Operational Temperature Range : -40°C ~ 85°C
- Ultra Small Packages : SOT-25 (250mW),
SOT-89 (500mW),
TO-92 (300mW)

Capacitors can be Tantalum or Ceramic

Typical Application Circuit

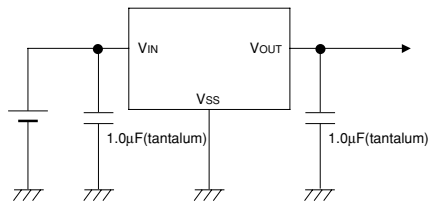

Typical Performance Characteristic

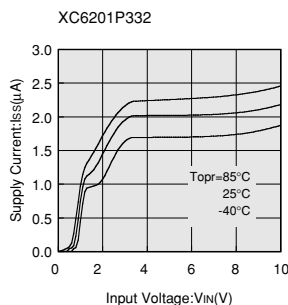

XC6201 Series

Pin Configuration

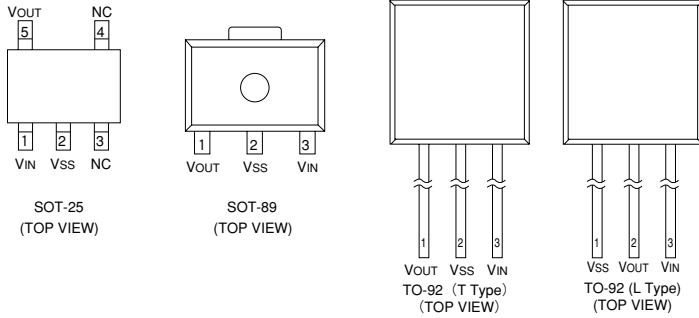

3

Pin Assignment

PIN NUMBER			PIN NAME	FUNCTION
SOT-25	SOT-89/TO-92 (T)	TO-92 (L)		
5	1	2	VOUT	Output
2	2	1	VSS	Ground
1	3	3	VIN	Power Input
3	—	—	(NC)	No Connection
4	—	—	(NC)	No Connection

Product Classification

Ordering Information

X C 6 2 0 1 P ③④⑤⑥
 ↑ ↑
 ① ②

DESIGNATOR	SYMBOL	DESCRIPTION	DESIGNATOR	SYMBOL	DESCRIPTION
①	01	Indicates the product number	④	1/2	Output Voltage Accuracy e.g.1 : $\pm 1.0\%$ 2 : $\pm 2.0\%$
②	P	Type of regulator 3-pin		⑤	M
③	13~60	Output Voltage e.g. 30 : 3.0V 50 : 5.0V	P		: SOT-89
			T		: TO-92 (Standard)
			L		: TO-92 (Custom pin configuration)
⑥	R	Embossed Tape:Standard Feed	⑥	L	Embossed Tape:Reverse Feed
	H	Paper Type (TO-92)		B	Bag (TO-92)
	B	Bag (TO-92)			

■ Packaging Information

● SOT-25

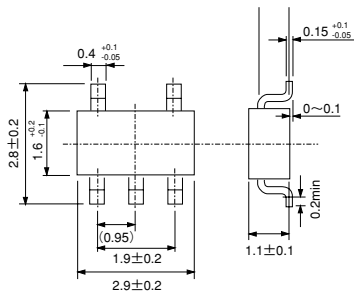

3

● SOT-89

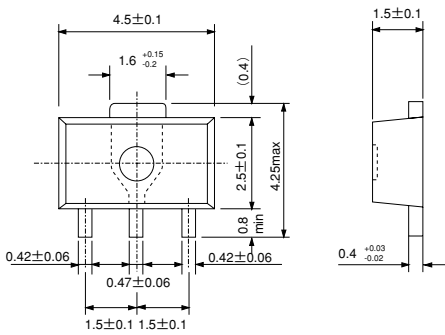

XC6201 Series

●TO-92

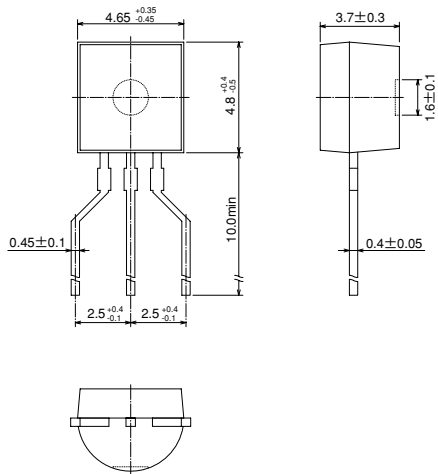

3

■ **Marking**

● SOT-89, SOT-25

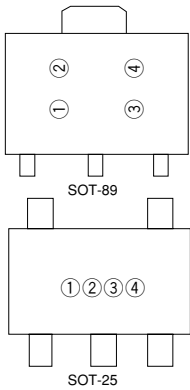

① Represents the product name

SYMBOL	PRODUCT NAME
1	XC6201PXXXXX

② Represents the type of regulator

VOLTAGE (V)	0.1~3.0	3.1~6.0	6.1~9.0
SYMBOL	5	6	7

③ Represents the Output Voltage

SYMBOL	OUTPUT VOLTAGE (V)			SYMBOL	OUTPUT VOLTAGE (V)		
0	—	3.1	—	F	1.6	4.6	—
1	—	3.2	—	H	1.7	4.7	—
2	—	3.3	—	K	1.8	4.8	—
3	—	3.4	—	L	1.9	4.9	—
4	—	3.5	—	M	2.0	5.0	—
5	—	3.6	—	N	2.1	5.1	—
6	—	3.7	—	P	2.2	5.2	—
7	—	3.8	—	R	2.3	5.3	—
8	—	3.9	—	S	2.4	5.4	—
9	—	4.0	—	T	2.5	5.5	—
A	—	4.1	—	U	2.6	5.6	—
B	—	4.2	—	V	2.7	5.7	—
C	1.3	4.3	—	X	2.8	5.8	—
D	1.4	4.4	—	Y	2.9	5.9	—
E	1.5	4.5	—	Z	3.0	6.0	—

④ Represents the assembly lot no.

0~9, A~Z repeated (G, I, J, O, Q, W excepted)

3

XC6201 Series

●TO-92

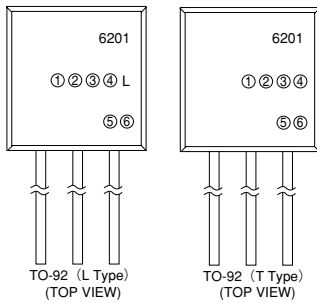

① Represents the type of regulator

DESIGNATOR	PRODUCT NAME
P	XC6201P*****
T	XC6201T*****

②③ Represents the Output Voltage

DESIGNATOR	DESIGNATOR	VOLTAGE (V)	PRODUCT NAME
②	③		
3	3	3.3	XC6201*33***
5	0	5.0	XC6201*50***

④ Represents the Detect Voltage Accuracy

DESIGNATOR	DETECT VOLTAGE ACCURACY	PRODUCT NAME
1	within $\pm 1\%$	XC6201P**1**
2	within $\pm 2\%$	XC6201P**2**

⑤ Represents a least significant digit of the produced year

DESIGNATOR	Produced year
0	2000
1	2001

⑥ Denotes the production lot number
0 to 9, A to Z repeated (G, I, J, O, Q, W excepted)

Note : Character inversion is not used

■Block Diagram

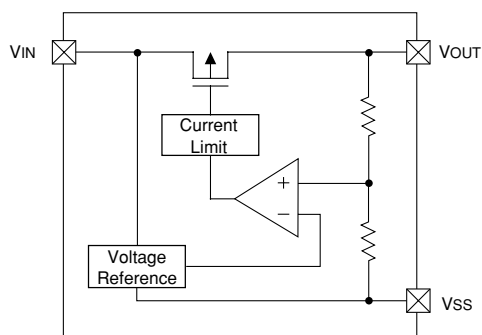

■ Absolute Maximum Ratings

Ta=25°C

PARAMETER	SYMBOL	RATINGS	UNITS
Input Voltage	VIN	12	V
Output Current	IOUT	500	mA
Output Voltage	VOUT	VSS-0.3~VIN+0.3	V
Power Dissipation	SOT-25	Pd	mW
	SOT-89		
	TO-92		
Operating Temp.	Topr	-40~+85	°C
Storage Temp.	Tstg	-55~+125	°C

3

■ Electrical Characteristics

XC6201P132 VOUT(T)=1.3V (Note 1)

Ta=25°C

PARAMETER	SYMBOL	CONDITIONS	MIN	TYP	MAX	UNITS	CIRCUIT
Output Voltage	VOUT(E) (Note 2)	VIN=2.3V IOUT=10mA	1.274	1.300	1.326	V	2
Maximum Output Current	IOUTmax	VIN=2.3V VOUT(E)≥1.17V	60			mA	2
Load Regulation	ΔVOUT	VIN=2.3V 1mA≤IOUT≤30mA		10	30	mV	2
Dropout Voltage (Note 3)	Vdif1	IOUT=30mA		200	600	mV	2
	Vdif2	IOUT=60mA		500	810		
Supply Current	ISS	VIN=2.3V		3.0	5.0	μA	1
Line Regulation	$\frac{\Delta VOUT}{\Delta VIN \cdot VOUT}$	IOUT=10mA 2.3V≤VIN≤10.0V		0.2	0.3	%/V	2
Input Voltage	VIN		1.8		10	V	—
Output Voltage Temperature Characteristics	$\frac{\Delta VOUT}{\Delta Topr \cdot VOUT}$	IOUT=40mA -40°C≤Topr≤85°C		±100		ppm/°C	2

XC6201 Series

XC6201P182 $V_{OUT}(T)=1.8V$ (Note 1) Ta=25°C

PARAMETER	SYMBOL	CONDITIONS	MIN	TYP	MAX	UNITS	CIRCUIT
Output Voltage	$V_{OUT}(E)$ (Note 2)	$V_{IN}=2.8V$ $I_{OUT}=40mA$	1.764	1.800	1.836	V	2
Maximum Output Current	I_{OUTmax}	$V_{IN}=2.8V$ $V_{OUT}(E) \geq 1.62V$	80			mA	2
Load Regulation	ΔV_{OUT}	$V_{IN}=2.8V$ $1mA \leq I_{OUT} \leq 40mA$		10	30	mV	2
Dropout Voltage (Note 3)	V_{dif1}	$I_{OUT}=40mA$		200	370	mV	2
	V_{dif2}	$I_{OUT}=80mA$		450	710		
Supply Current	I_{SS}	$V_{IN}=2.8V$		3.0	5.0	μA	1
Line Regulation	$\frac{\Delta V_{OUT}}{\Delta V_{IN} \cdot V_{OUT}}$	$I_{OUT}=40mA$ $2.8V \leq V_{IN} \leq 10.0V$		0.2	0.3	%/V	2
Input Voltage	V_{IN}		1.8		10	V	—
Output Voltage Temperature Characteristics	$\frac{\Delta V_{OUT}}{\Delta T_{opr} \cdot V_{OUT}}$	$I_{OUT}=40mA$ $-40^{\circ}C \leq T_{opr} \leq 85^{\circ}C$		± 100		ppm /°C	2

XC6201P272 $V_{OUT}(T)=2.7V$ (Note 1) Ta=25°C

PARAMETER	SYMBOL	CONDITIONS	MIN	TYP	MAX	UNITS	CIRCUIT
Output Voltage	$V_{OUT}(E)$ (Note 2)	$V_{IN}=3.7V$ $I_{OUT}=40mA$	2.646	2.700	2.754	V	2
Maximum Output Current	I_{OUTmax}	$V_{IN}=3.7V$ $V_{OUT}(E) \geq 2.43V$	100			mA	2
Load Regulation	ΔV_{OUT}	$V_{IN}=3.7V$ $1mA \leq I_{OUT} \leq 60mA$		15	40	mV	2
Dropout Voltage (Note 3)	V_{dif1}	$I_{OUT}=60mA$		200	370	mV	2
	V_{dif2}	$I_{OUT}=120mA$		450	710		
Supply Current	I_{SS}	$V_{IN}=3.7V$		2.0	5.0	μA	1
Line Regulation	$\frac{\Delta V_{OUT}}{\Delta V_{IN} \cdot V_{OUT}}$	$I_{OUT}=40mA$ $3.7V \leq V_{IN} \leq 10.0V$		0.2	0.3	%/V	2
Input Voltage	V_{IN}		1.8		10	V	—
Output Voltage Temperature Characteristics	$\frac{\Delta V_{OUT}}{\Delta T_{opr} \cdot V_{OUT}}$	$I_{OUT}=40mA$ $-40^{\circ}C \leq T_{opr} \leq 85^{\circ}C$		± 100		ppm /°C	2

XC6201
Series

XC6201P332 $V_{OUT}(T)=3.3V$ (Note 1) Ta=25°C

PARAMETER	SYMBOL	CONDITIONS	MIN	TYP	MAX	UNITS	CIRCUIT
Output Voltage	$V_{OUT}(E)$ (Note 2)	$V_{IN}=4.3V$ $I_{OUT}=40mA$	3.234	3.300	3.366	V	2
Maximum Output Current	I_{OUTmax}	$V_{IN}=4.3V$ $V_{OUT}(E) \geq 2.97V$	150			mA	2
Load Regulation	ΔV_{OUT}	$V_{IN}=4.3V$ $1mA \leq I_{OUT} \leq 80mA$		20	50	mV	2
Dropout Voltage (Note 3)	V_{dif1}	$I_{OUT}=80mA$		200	360	mV	2
	V_{dif2}	$I_{OUT}=160mA$		450	700		
Supply Current	ISS	$V_{IN}=4.3V$		2.0	5.0	μA	1
Line Regulation	$\frac{\Delta V_{OUT}}{\Delta V_{IN} \cdot V_{OUT}}$	$I_{OUT}=40mA$ $4.3V \leq V_{IN} \leq 10.0V$		0.2	0.3	%/V	2
Input Voltage	V_{IN}		1.8		10	V	—
Output Voltage Temperature Characteristics	$\frac{\Delta V_{OUT}}{\Delta T_{opr} \cdot V_{OUT}}$	$I_{OUT}=40mA$ $-40^\circ C \leq T_{opr} \leq 85^\circ C$		± 100		ppm /°C	2

3

XC6201P502 $V_{OUT}(T)=5.0V$ (Note 1) Ta=25°C

PARAMETER	SYMBOL	CONDITIONS	MIN	TYP	MAX	UNITS	CIRCUIT
Output Voltage	$V_{OUT}(E)$ (Note 2)	$V_{IN}=6.0V$ $I_{OUT}=40mA$	4.900	5.000	5.100	V	2
Maximum Output Current	I_{OUTmax}	$V_{IN}=6.0V$ $V_{OUT}(E) \geq 4.5V$	200			mA	2
Load Regulation	ΔV_{OUT}	$V_{IN}=6.0V$ $1mA \leq I_{OUT} \leq 100mA$		30	70	mV	2
Dropout Voltage (Note 3)	V_{dif1}	$I_{OUT}=100mA$		160	340	mV	2
	V_{dif2}	$I_{OUT}=200mA$		400	600		
Supply Current	ISS	$V_{IN}=6.0V$		2.0	6.0	μA	1
Line Regulation	$\frac{\Delta V_{OUT}}{\Delta V_{IN} \cdot V_{OUT}}$	$I_{OUT}=40mA$ $6.0V \leq V_{IN} \leq 10.0V$		0.2	0.3	%/V	2
Input Voltage	V_{IN}		1.8		10	V	—
Output Voltage Temperature Characteristics	$\frac{\Delta V_{OUT}}{\Delta T_{opr} \cdot V_{OUT}}$	$I_{OUT}=40mA$ $-40^\circ C \leq T_{opr} \leq 85^\circ C$		± 100		ppm /°C	2

- Note :
1. $V_{OUT}(T)$ = Specified Output Voltage.
 2. $V_{OUT}(E)$ = Effective Output Voltage (i.e. the output voltage when " $V_{OUT}(T)+1.0V$ " is provided while maintaining a certain I_{OUT} value).
 3. $V_{dif} = \{ V_{IN1} (Note5) - V_{OUT1} (Note4) \}$
 4. V_{OUT1} = A voltage equal to 98% of the output voltage when a stabilised ($V_{OUT}(T) + 1.0V$) is input.
 5. V_{IN1} = The input voltage at the time V_{OUT1} is output (input voltage has been gradually reduced).

XC6201 Series

■ Typical Application Circuit

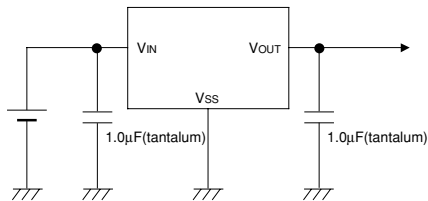

3

< External Capacitors >

The XC6201 requires an output capacitor between the V_{OUT} pin and the V_{SS} pin in order to obtain stable output voltages. Where output voltage is greater than 1.7V, the output capacitor (C_L) used should be more than 0.1µF whether using tantalum or low ESR (ceramic, for example) capacitors. Where output voltage is between 1.3V - 1.6V, it is recommended that only a tantalum capacitor of more than 2.2µF be used on the output in order to stabilize operations.

Output Voltage	C _{IN}	C _L (tantalum)	C _L (low ESR)
1.3V~1.6V	greater than 0.1µF	greater than 2.2µF	-
1.7V~6.0V	greater than 0.1µF	greater than 0.1µF	greater than 0.1µF

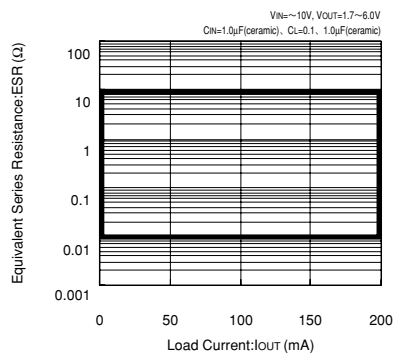

Directions for use

Notes on Use

1. Please use this IC within the stipulated absolute maximum ratings as the IC is liable to malfunction outside of such parameters. When the voltage on V_{OUT} is larger than that of V_{IN} , for example, when there are two power supply, please insert schottky diode between V_{OUT} and V_{IN} not to exceed the rating of V_{OUT} .
2. There is a possibility that oscillation may occur as a result of the impedance present between the power supply and the IC's input. Where impedance is 10Ω or more, please use a capacitor (C_{IN}) of at least $1\mu F$.
With a large output current, operations can be stabilised by increasing capacitor size (C_{IN}). If C_{IN} is small and capacitor size (C_L) is increased, there is a possibility of oscillation due to input impedance.
In such cases, operations can be stabilised by either increasing the size of C_{IN} or decreasing the size of C_L .
3. Please ensure that output current (I_{OUT}) is less than $P_d + (V_{IN} - V_{OUT})$ and does not exceed the stipulated Continuous Total Power Dissipation value (P_d) for the package.

3

Test Circuits

Measuring Circuit 1 : Supply Current

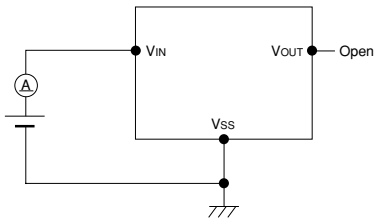

Measuring Circuit 2 : Output Voltage, Oscillation Check, Line Regulation, Dropout Voltage, Load Regulation

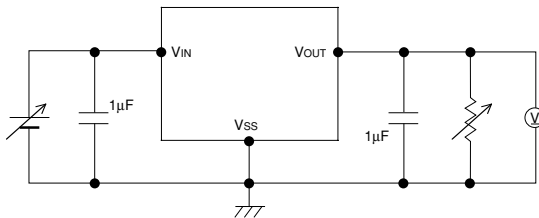

XC6201 Series

Typical Performance Characteristics

(1) OUTPUT VOLTAGE vs. OUTPUT CURRENT

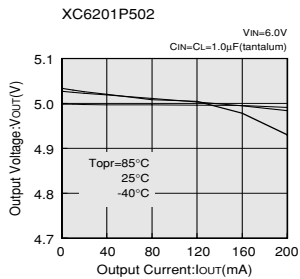
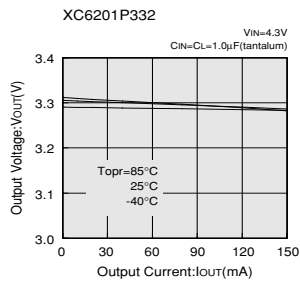
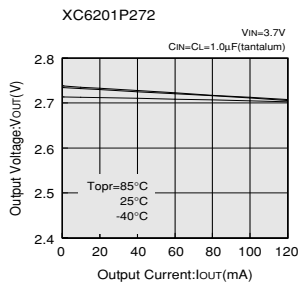
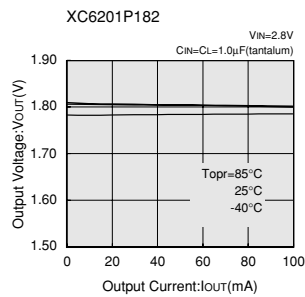
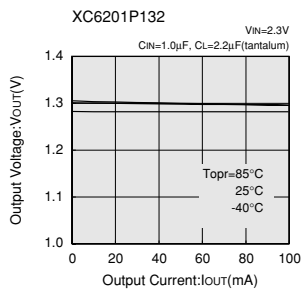

(2) OUTPUT VOLTAGE vs. INPUT VOLTAGE

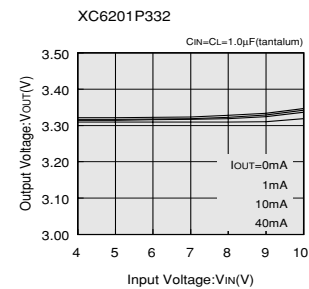
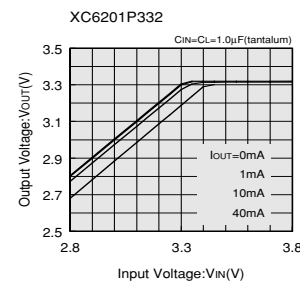
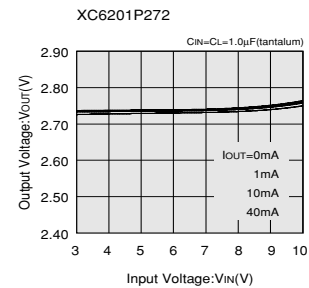
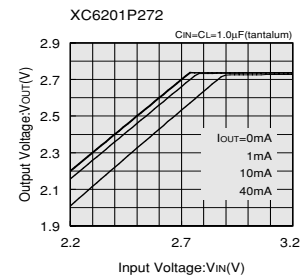
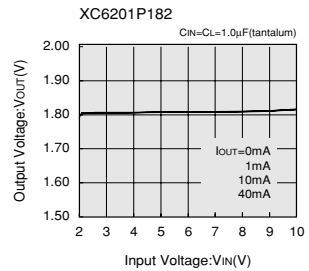
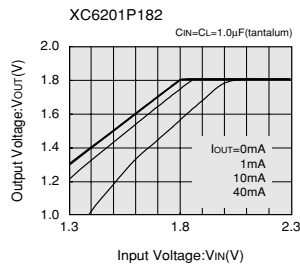
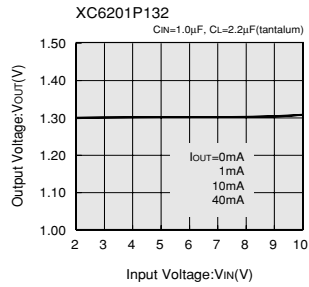
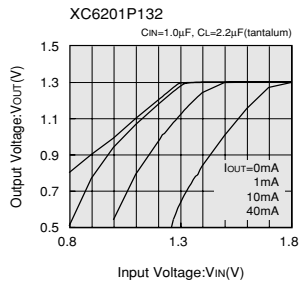

XC6201 Series

(2) OUTPUT VOLTAGE vs. INPUT VOLTAGE

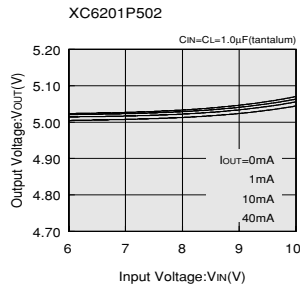
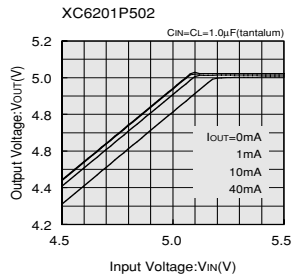

(3) DROPOUT VOLTAGE vs. OUTPUT CURRENT

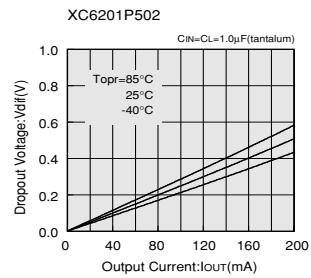
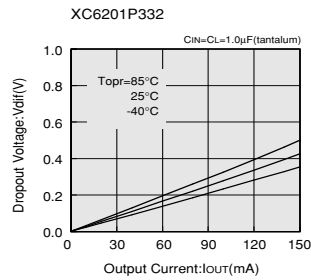
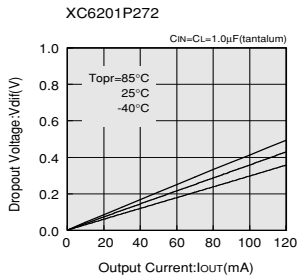
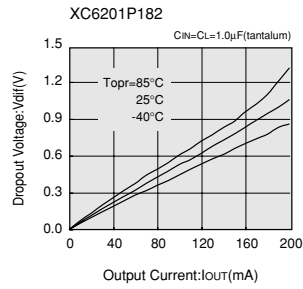
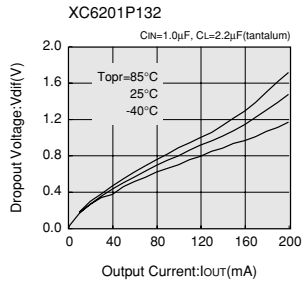

3

XC6201 Series

(4) SUPPLY CURRENT vs. INPUT VOLTAGE

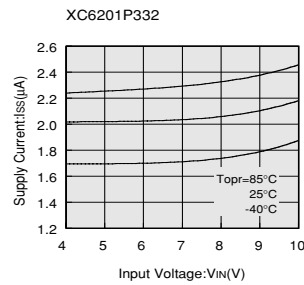
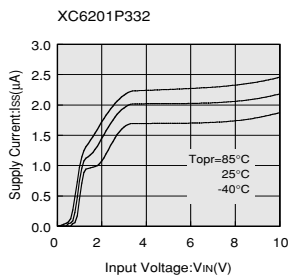
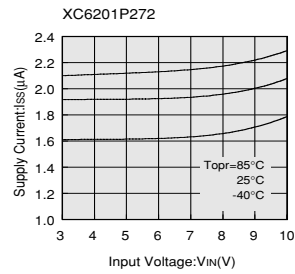
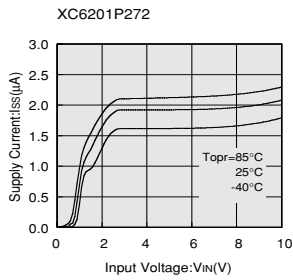
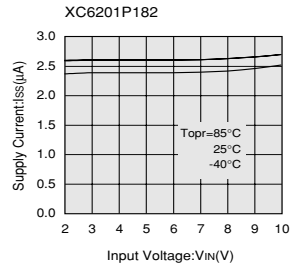
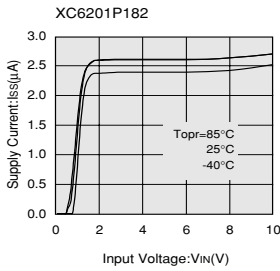
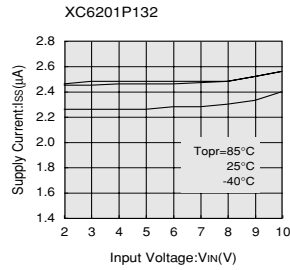
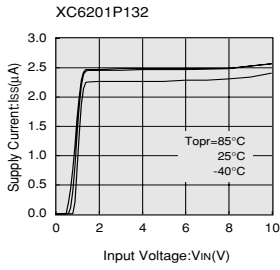

(4) SUPPLY CURRENT vs. INPUT VOLTAGE

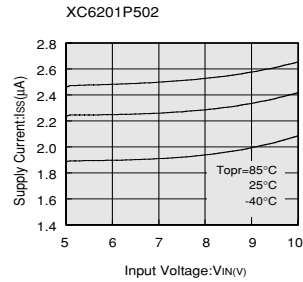
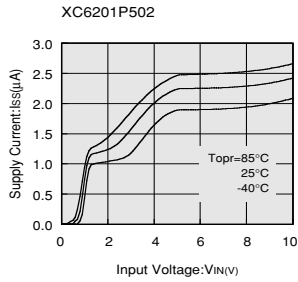

3

XC6201 Series

(5) OUTPUT VOLTAGE vs. AMBIENT TEMPERATURE

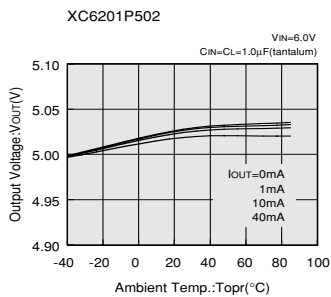
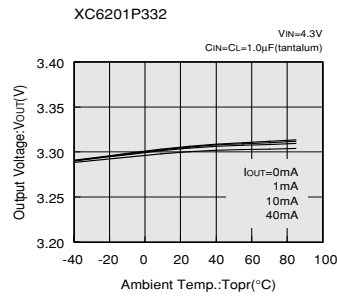
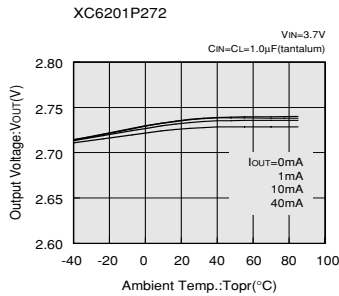
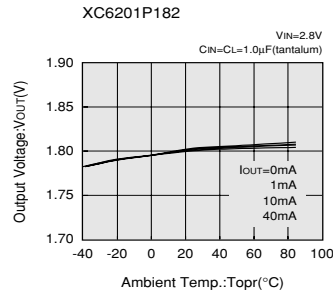
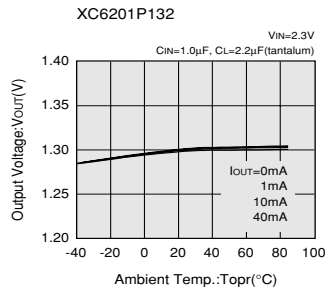

(6) SUPPLY CURRENT vs. AMBIENT TEMPERATURE

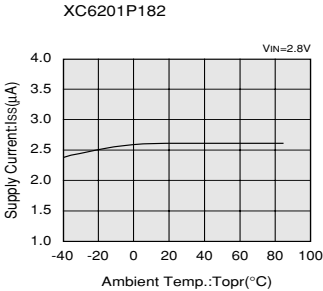
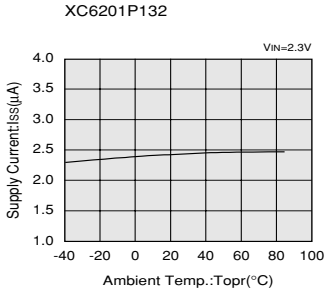

3

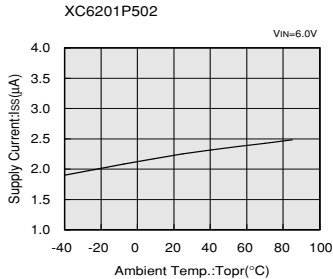
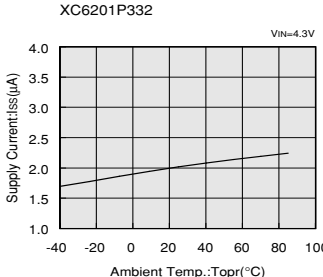
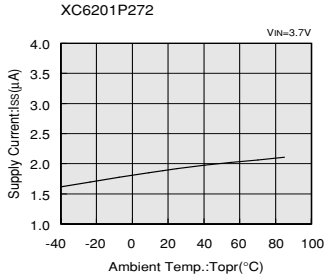

XC6201 Series

(7) INPUT TRANSIENT RESPONSE

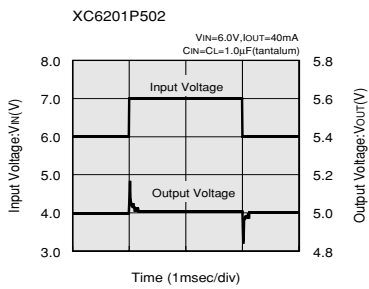
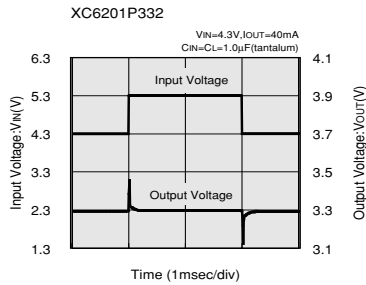
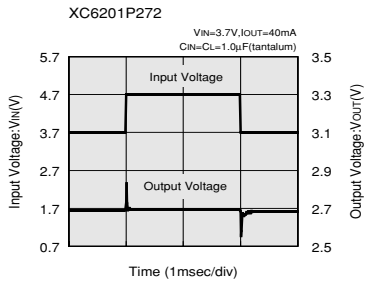
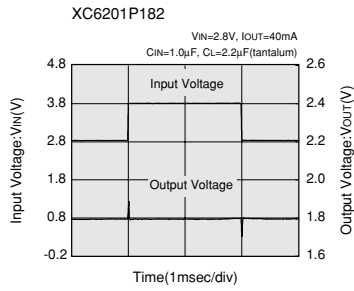
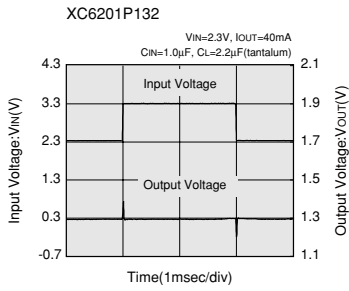

(8) LOAD TRANSIENT RESPONSE

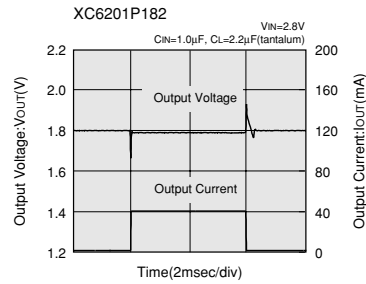
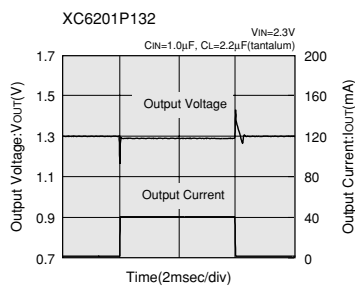

3

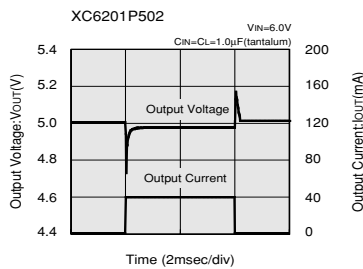
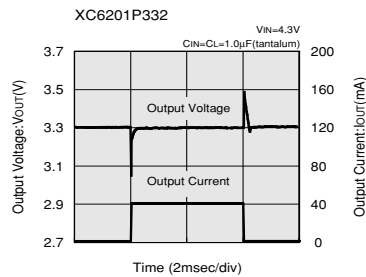
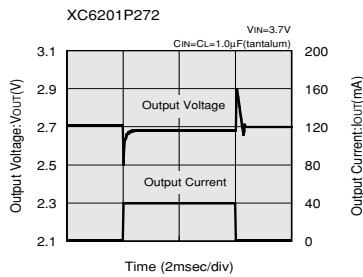

XC6201 Series

(9) RIPPLE REJECTION RATE

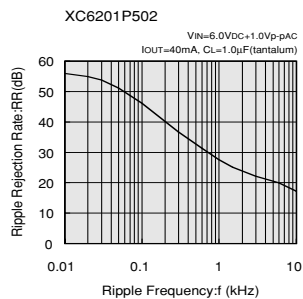
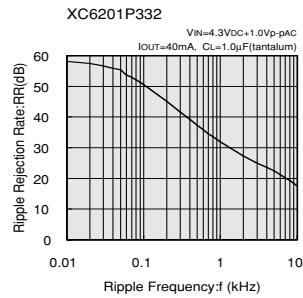
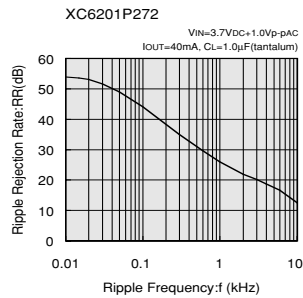
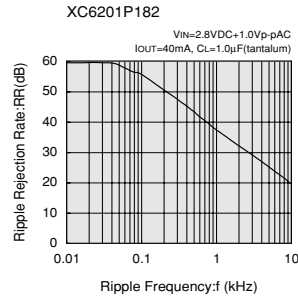
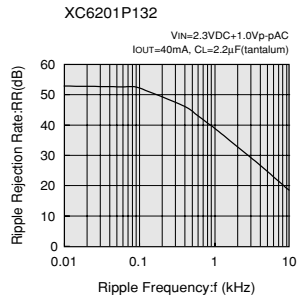

(10) OUTPUT NOISE DENSITY

