

XC62FP Series

Positive Voltage Regulators



- ◆ CMOS Low Power Consumption
- ◆ Small Input-Output Voltage Differential
 - : 0.12V @ 100mA,
 - 0.38V @ 200mA
- ◆ Maximum Output Current : 250mA (V_{OUT}=5.0V)
- ◆ Output Voltage Range : 2.0V~6.0V
- ◆ Highly Accurate : ±2% (±1%)

Applications

- Battery Powered Equipment
- Palmtops
- Portable Cameras and Video Recorders
- Reference Voltage Sources

3

General Description

The XC62FP series is a group of positive voltage output, three-pin regulators, that provide a high current even when the input/output voltage differential is small. Low power consumption and high accuracy is achieved through CMOS and laser trimming technologies.

The XC62FP consists of a high-precision voltage reference, an error amplification circuit, and a current limited output driver. Transient response to load variations have improved in comparison to the existing series.

SOT-23 (150mW), SOT-89 (500mW) and TO-92 (300mW) packages are available.

Features

- Maximum Output Current**
 - : 250mA
 - (within max. power dissipation, V_{OUT} = 5.0V)
- Output Voltage Range**
 - : 2.0V ~ 6.0V in 0.1V increments
 - (1.5V ~ 1.9V for custom products)
- Highly Accurate**: Output voltage ±2%
(±1% for semi-custom products)
- Low Power Consumption**
 - : Typ. 2.0µA @ V_{OUT}=5.0V
- Output Voltage Temperature Characteristics**
 - : Typ. ±100ppm/°C
- Input Stability** : Typ. 0.2%/V
- Small Input-Output Differential**
 - : I_{OUT} = 100mA @ V_{OUT} = 5.0V with a 0.12V differential.
- Ultra Small Packages**
 - : SOT-23 (150mW) mini-mold,
 - SOT-89 (500mW) mini-power mold
 - TO-92 (300mW)

Typical Application Circuit

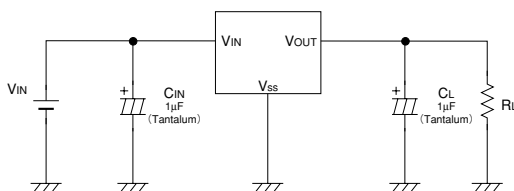

Typical Performance Characteristic

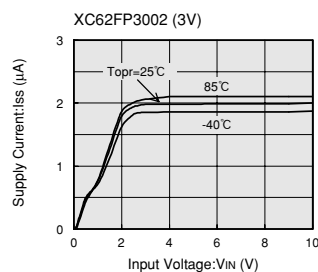

XC62FP Series

Pin Configuration

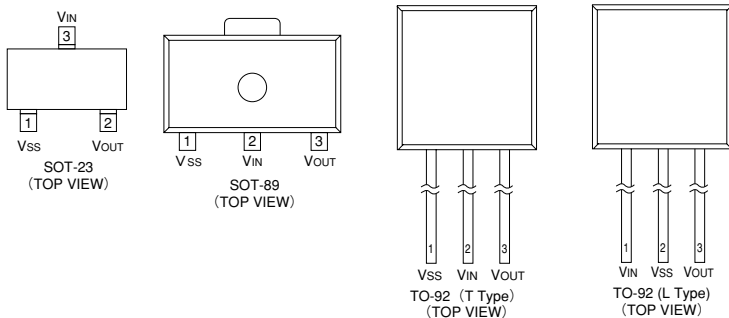

3

Pin Assignment

PIN NUMBER				PIN NAME	FUNCTION
SOT-23	SOT-89	TO-92 (T)	TO-92 (L)		
1	1	1	2	V _{SS}	Ground
3	2	2	1	V _{IN}	Supply voltage input
2	3	3	3	V _{OUT}	Regulated voltage output

Product Classification

Ordering Information

XC62FXXXXXX
 ↑ ↑ ↑ ↑ ↑ ↑
 a b c d e f

DESIGNATOR	DESCRIPTION	DESIGNATOR	DESCRIPTION
a	Polarity of Output Voltage: P: + (Positive)	e	Package Type M=SOT-23 P=SOT-89 T=TO-92 (Standard) L=TO-92 (Custom pin configuration)
b	Output Voltage 30=3.0V 50=5.0V		
c	Temperature Coefficients: 0=±100ppm (typical)	f	Device Orientation R=Embossed Tape (Standard Feed) L=Embossed Tape (Reverse Feed) H=Paper Tape (TO-92) B=Bag (TO-92)
d	Output Voltage Accuracy: 1=±1.0% (Semi-custom) 2=±2.0%		

■ Packaging Information

● SOT-23

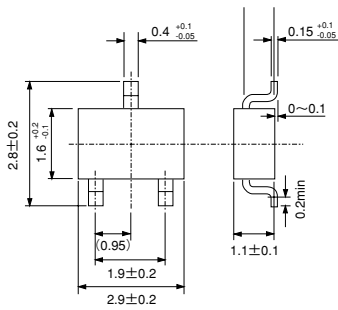

3

● SOT-89

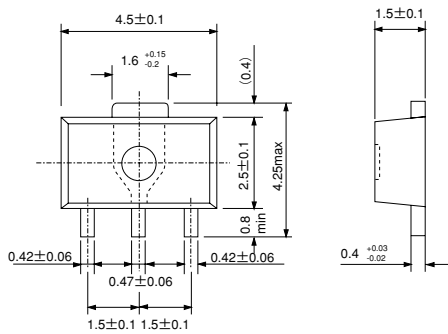

XC62FP Series

●TO-92

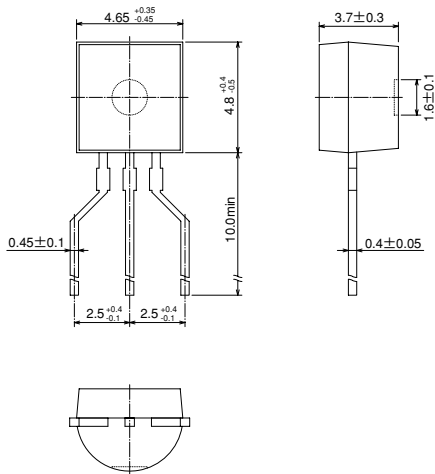

3

■Marking

●SOT-23, SOT-89

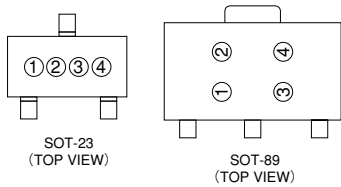

① Represents the integer of the Output Voltage

SYMBOL	VOLTAGE(V)	SYMBOL	VOLTAGE(V)
1	1.②	5	5.②
2	2.②	6	6.②
3	3.②		
4	4.②		

② Represents the decimal number of the Output Voltage

SYMBOL	VOLTAGE(V)	SYMBOL	VOLTAGE(V)
A	①.0	F	①.5
B	①.1	H	①.6
C	①.2	K	①.7
D	①.3	L	①.8
E	①.4	M	①.9

③ Based on internal standards

SYMBOL
0

④ Represents the assembly lot no.
Based on internal standards

●TO-92

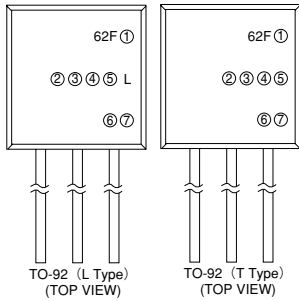

① Represents the polarity of Output Voltage

DESIGNATOR	CONFIGURATION
P	CMOS

④ Represents the temperature characteristics

DESIGNATOR	TEMPERATURE CHARACTERISTICS
0	TPY±100ppm

⑥ Represents a least significant digit of the produced year

DESIGNATOR	PRODUCED YEAR
0	2000
1	2001

⑦ Denotes the production lot number
0 to 9, A to Z repeated (G,I,J,O,Q,W excepted)

②③ Represents the Detect Voltage

DESIGNATOR		VOLTAGE (V)
②	③	
3	3	3.3
5	0	5.0

⑤ Represents the Detect Voltage Accuracy

DESIGNATOR	DETECT VOLTAGE ACCURACY
1	within ±1% (semi-custom)
2	within ±2%

3

■Block Diagram

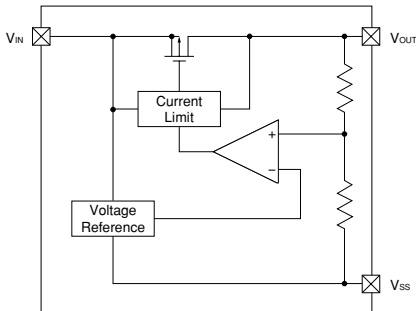

■Absolute Maximum Ratings

Ta=25°C

PARAMETER	SYMBOL	RATINGS	UNITS
Input Voltage	V _{IN}	12	V
Output Current	I _{OUT}	500	mA
Output Voltage	V _{OUT}	V _{SS} +0.3 ~ V _{IN} +0.3	V
Continuous Total Power Dissipation	SOT-23	P _d	150
	SOT-89		500
	TO-92		300
Operating Ambient Temperature	T _{opr}	-40 ~ +85	°C
Storage Temperature	T _{stg}	-40 ~ +125	°C

XC62FP Series

Electrical Characteristics

XC62FP5002 $V_{OUT}(T)=5.0V$ (Note1)

$T_a=25^\circ C$

PARAMETER	SYMBOL	CONDITIONS	MIN	TYP	MAX	UNITS	CIRCUIT
Output Voltage	$V_{OUT}(E)$ (Note2)	$I_{OUT}=40mA$ $V_{IN}=6.0V$	4.900	5.000	5.100	V	1
Maximum Output Current	$I_{OUT\ max}$	$V_{IN}=6.0V, V_{OUT}(E) \geq 4.5V$	250			mA	1
Load Stability	ΔV_{OUT}	$V_{IN}=6.0V$ $1mA \leq I_{OUT} \leq 100mA$		40	80	mV	1
Input -Output Voltage Differential (Note3)	V_{dif1}	$I_{OUT}=100mA$		120	300	mV	1
	V_{dif2}	$I_{OUT}=200mA$		380	600	mV	1
Supply Current	I_{SS}	$V_{IN}=6.0V$		2.0	4.5	μA	2
Input Stability	$\frac{\Delta V_{OUT}}{\Delta V_{IN} \cdot V_{OUT}}$	$I_{OUT}=40mA$ $6.0V \leq V_{IN} \leq 10.0V$		0.2	0.3	%/V	1
Input Voltage	V_{IN}				10	V	—
Output Voltage Temperature Characteristics	$\frac{\Delta V_{OUT}}{\Delta T_{opr} \cdot V_{OUT}}$	$I_{OUT}=40mA$ $-40^\circ C \leq T_{opr} \leq 85^\circ C$		± 100		ppm/ $^\circ C$	1

XC62FP4002 $V_{OUT}(T)=4.0V$ (Note1)

$T_a=25^\circ C$

PARAMETER	SYMBOL	CONDITIONS	MIN	TYP	MAX	UNITS	CIRCUIT
Output Voltage	$V_{OUT}(E)$ (Note2)	$I_{OUT}=40mA$ $V_{IN}=5.0V$	3.920	4.000	4.080	V	1
Maximum Output Current	$I_{OUT\ max}$	$V_{IN}=5.0V, V_{OUT}(E) \geq 3.6V$	200			mA	1
Load Stability	ΔV_{OUT}	$V_{IN}=5.0V$ $1mA \leq I_{OUT} \leq 100mA$		45	90	mV	1
Input -Output Voltage Differential (Note3)	V_{dif1}	$I_{OUT}=100mA$		170	330	mV	1
	V_{dif2}	$I_{OUT}=200mA$		400	630	mV	1
Supply Current	I_{SS}	$V_{IN}=5.0V$		2.0	4.5	μA	2
Input Stability	$\frac{\Delta V_{OUT}}{\Delta V_{IN} \cdot V_{OUT}}$	$I_{OUT}=40mA$ $5.0V \leq V_{IN} \leq 10.0V$		0.2	0.3	%/V	1
Input Voltage	V_{IN}				10	V	—
Output Voltage Temperature Characteristics	$\frac{\Delta V_{OUT}}{\Delta T_{opr} \cdot V_{OUT}}$	$I_{OUT}=40mA$ $-40^\circ C \leq T_{opr} \leq 85^\circ C$		± 100		ppm/ $^\circ C$	1

3

XC62FP
Series

XC62FP3002 $V_{OUT}(T)=3.0V$ (Note1)

$T_a=25^{\circ}C$

PARAMETER	SYMBOL	CONDITIONS	MIN	TYP	MAX	UNITS	CIRCUIT
Output Voltage	$V_{OUT}(E)$ (Note2)	$I_{OUT}=40mA$ $V_{IN}=4.0V$	2.940	3.000	3.060	V	1
Maximum Output Current	$I_{OUT\ max}$	$V_{IN}=4.0V, V_{OUT}(E) \geq 2.7V$	150			mA	1
Load Stability	ΔV_{OUT}	$V_{IN}=4.0V$ $1mA \leq I_{OUT} \leq 80mA$		45	90	mV	1
Input -Output Voltage Differential (Note3)	Vdif1	$I_{OUT}=80mA$		180	360	mV	1
	Vdif2	$I_{OUT}=160mA$		400	700	mV	1
Supply Current	I_{SS}	$V_{IN}=4.0V$		2.0	4.5	μA	2
Input Stability	$\frac{\Delta V_{OUT}}{\Delta V_{IN} \cdot V_{OUT}}$	$I_{OUT}=40mA$ $4.0V \leq V_{IN} \leq 10.0V$		0.2	0.3	%/V	1
Input Voltage	V_{IN}				10	V	—
Output Voltage Temperature Characteristics	$\frac{\Delta V_{OUT}}{\Delta T_{opr} \cdot V_{OUT}}$	$I_{OUT}=40mA$ $-40^{\circ}C \leq T_{opr} \leq 85^{\circ}C$		± 100		ppm/ $^{\circ}C$	1

3

XC62FP2002 $V_{OUT}(T)=2.0V$ (Note1)

$T_a=25^{\circ}C$

PARAMETER	SYMBOL	CONDITIONS	MIN	TYP	MAX	UNITS	CIRCUIT
Output Voltage	$V_{OUT}(E)$ (Note2)	$I_{OUT}=40mA$ $V_{IN}=3.0V$	1.960	2.000	2.040	V	1
Maximum Output Current	$I_{OUT\ max}$	$V_{IN}=3.0V, V_{OUT}(E) \geq 1.8V$	100			mA	1
Load Stability	ΔV_{OUT}	$V_{IN}=3.0V$ $1mA \leq I_{OUT} \leq 60mA$		45	90	mV	1
Input -Output Voltage Differential (Note3)	Vdif1	$I_{OUT}=60mA$		180	360	mV	1
	Vdif2	$I_{OUT}=120mA$		400	700	mV	1
Supply Current	I_{SS}	$V_{IN}=3.0V$		2.0	4.5	μA	2
Input Stability	$\frac{\Delta V_{OUT}}{\Delta V_{IN} \cdot V_{OUT}}$	$I_{OUT}=40mA$ $3.0V \leq V_{IN} \leq 10.0V$		0.2	0.3	%/V	1
Input Voltage	V_{IN}				10	V	—
Output Voltage Temperature Characteristics	$\frac{\Delta V_{OUT}}{\Delta T_{opr} \cdot V_{OUT}}$	$I_{OUT}=40mA$ $-40^{\circ}C \leq T_{opr} \leq 85^{\circ}C$		± 100		ppm/ $^{\circ}C$	1

- Note:
1. $V_{OUT}(T)$ =Specified Output Voltage .
 2. $V_{OUT}(E)$ =Effective Output Voltage (i.e. the output voltage when " $V_{OUT}(T)+1.0V$ " is provided at the V_{IN} pin while maintaining a certain I_{OUT} value).
 3. $V_{dif} = (V_{IN1} - V_{OUT}(E))$.
 4. V_{IN1} = The input voltage at the time 98% of $V_{OUT}(E)$ is output (input voltage has been gradually reduced).

XC62FP Series

Typical Application Circuit

Standard Circuit

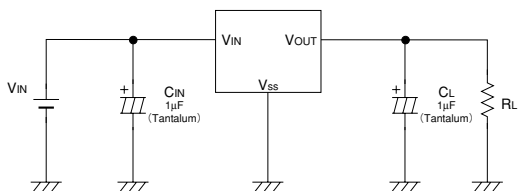

3

Directions for use

Notes on Use

1. Please use this IC within the stipulated absolute maximum ratings as the IC is liable to malfunction outside of such parameters.
2. There is a possibility that oscillation may occur as a result of the impedance present between the power supply and the IC's input. Where impedance is 10Ω or more, please use a capacitor (C_{IN}) of at least $1\mu F$.
With a large output current, operations can be stabilised by increasing capacitor size (C_{IN}). If C_{IN} is small and capacitor size (C_L) is increased, there is a possibility of oscillation due to input impedance.
In such cases, operations can be stabilised by either increasing the size of C_{IN} or decreasing the size of C_L .
3. Please ensure that output current (I_{OUT}) is less than $P_d \div (V_{IN} - V_{OUT})$ and does not exceed the stipulated Continuous Total Power Dissipation value (P_d) for the package.
4. Should you wish to increase output current (I_{OUT}) and/or have the capability to exceed the stipulated P_d value, using a current boost circuit (similar to the one shown below) is likely to lead to oscillation.
With such applications, we recommend use of a boost type voltage regulator, such as the Torex XC62EP series.

Current Boost Circuit : Poor Example

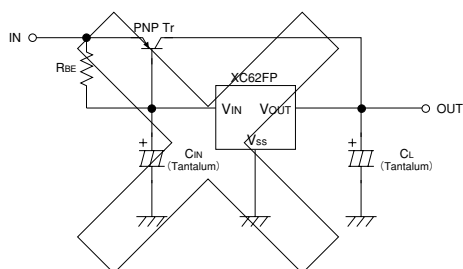

■ Test Circuits

Circuit 1

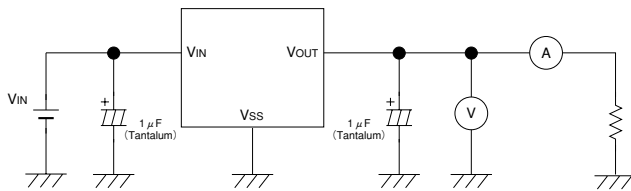

3

Circuit 2

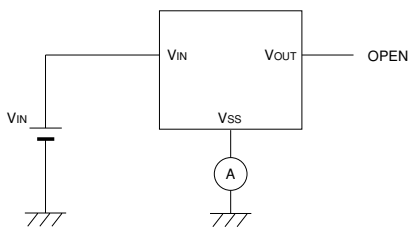

XC62FP Series

Typical Performance Characteristics

(1) OUTPUT VOLTAGE vs. OUTPUT CURRENT

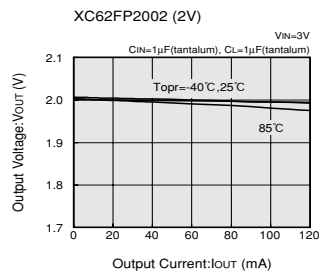
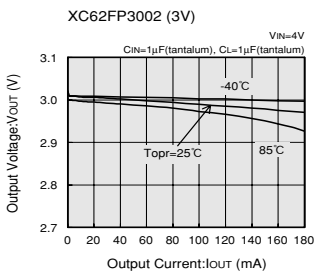
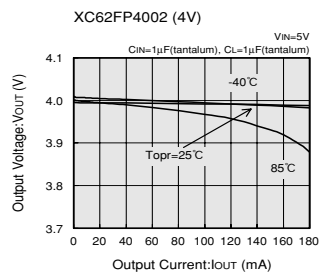
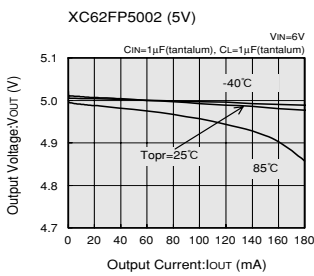

(2) OUTPUT VOLTAGE vs. INPUT VOLTAGE

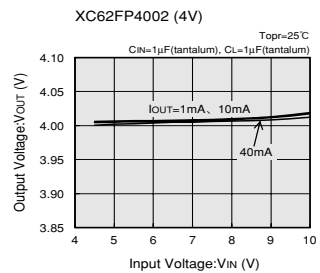
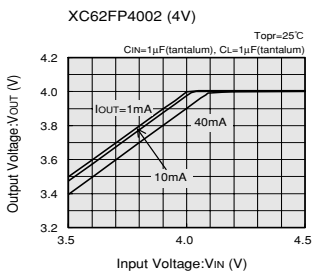
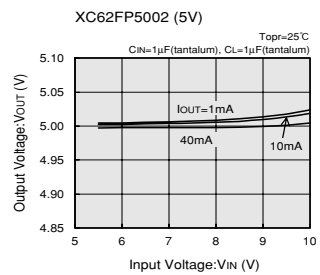
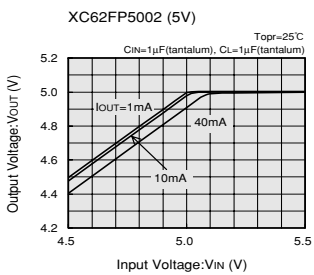

(2) OUTPUT VOLTAGE vs. INPUT VOLTAGE

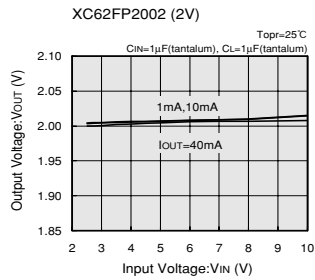
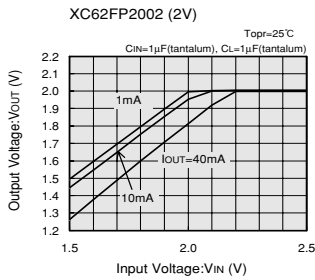
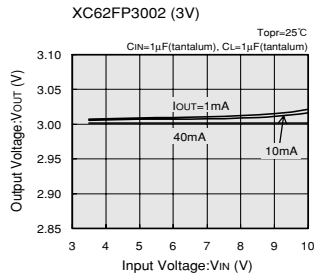
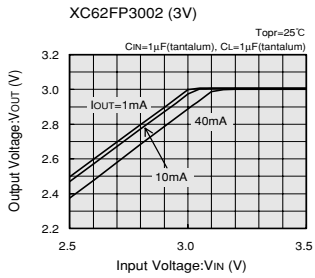

3

(3) INPUT/OUTPUT VOLTAGE DIFFERENTIAL vs. OUTPUT CURRENT

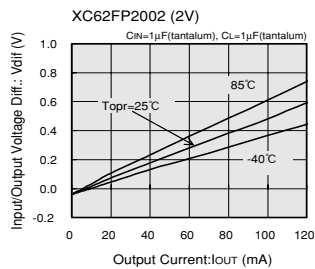
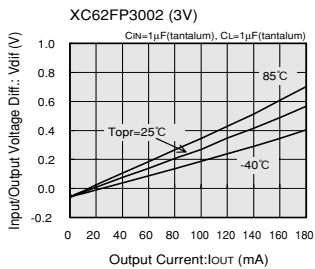
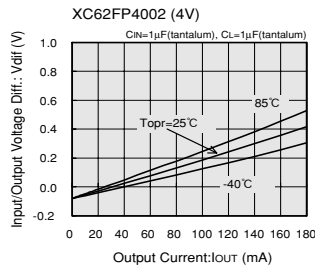
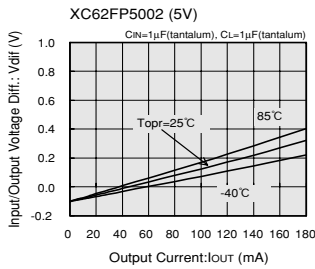

XC62FP Series

(4) SUPPLY CURRENT vs. INPUT VOLTAGE

3

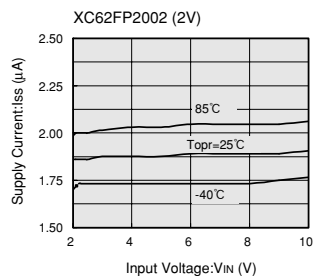
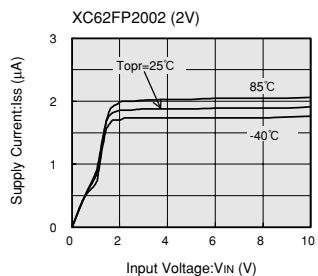
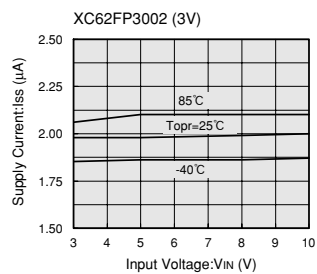
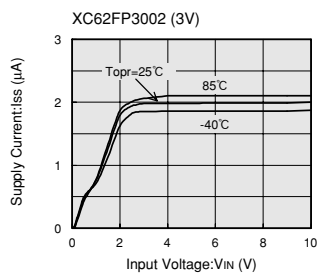
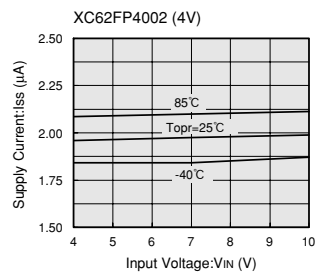
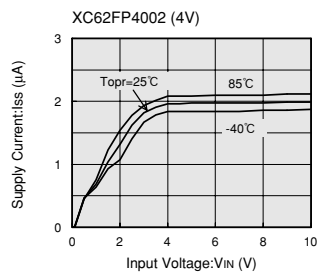
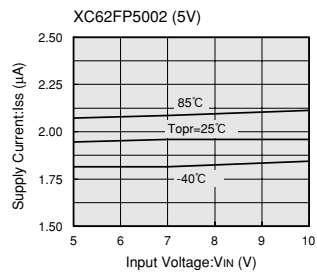
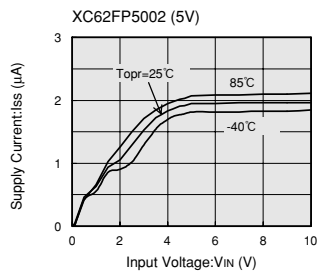

(5) OUTPUT VOLTAGE vs. AMBIENT TEMPERATURE

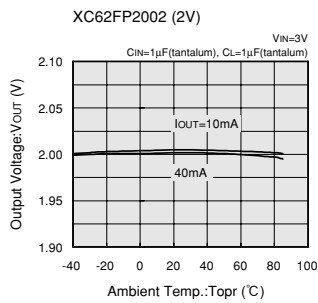
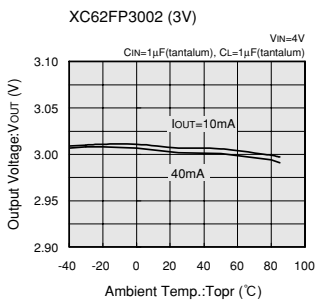
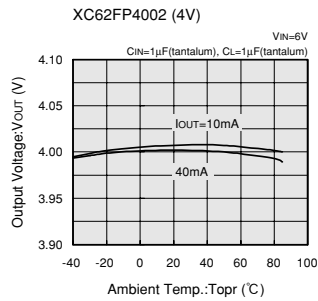
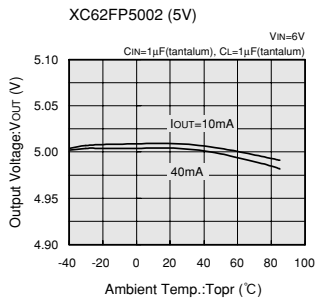

3

(6) SUPPLY CURRENT vs. AMBIENT TEMPERATURE

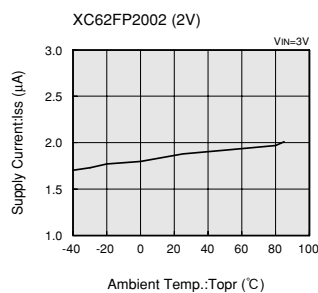
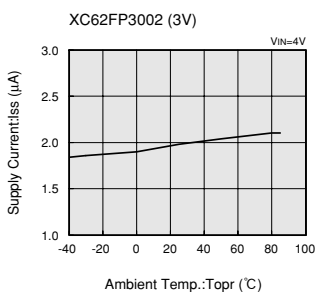
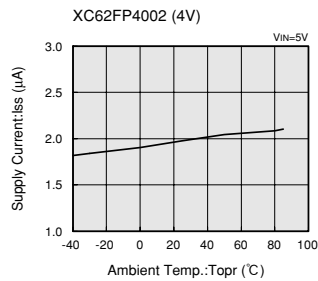
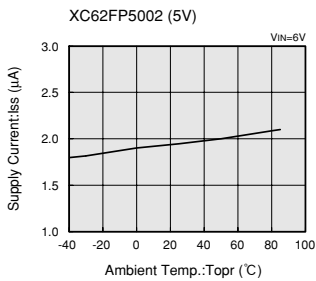

XC62FP Series

(7) INPUT TRANSIENT RESPONSE 1

3

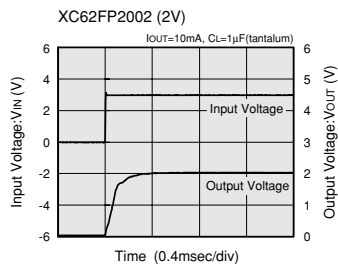
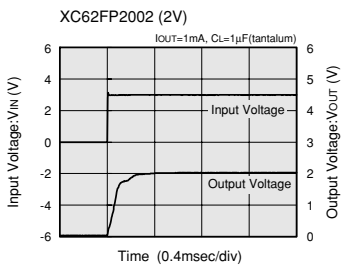
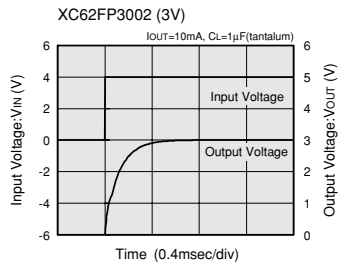
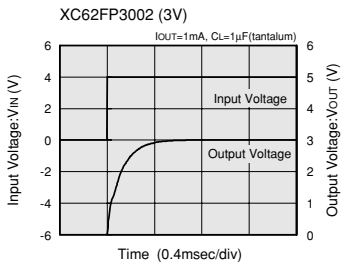
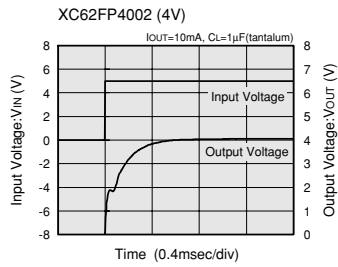
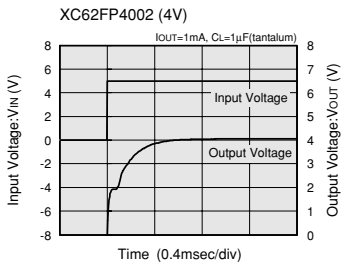
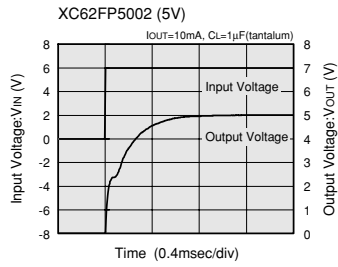
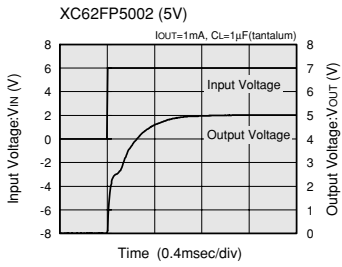

(8) INPUT TRANSIENT RESPONSE 2

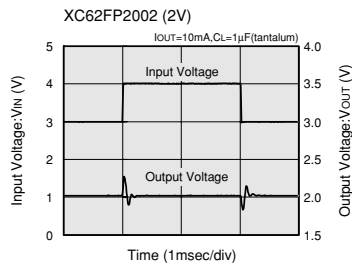
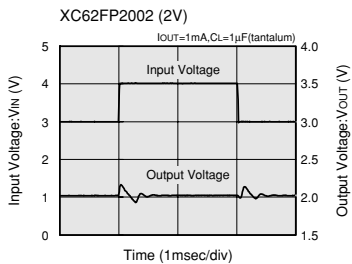
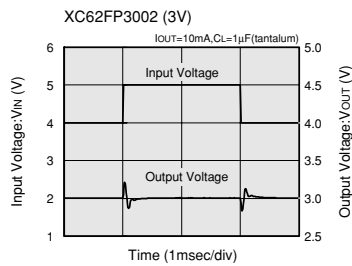
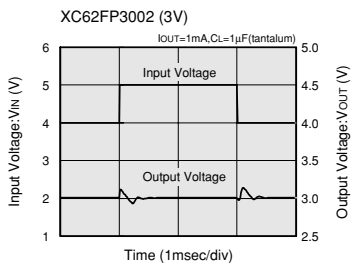
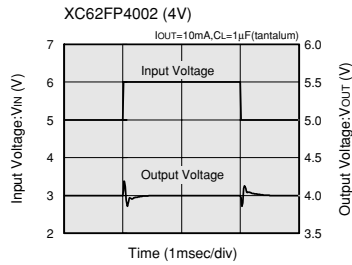
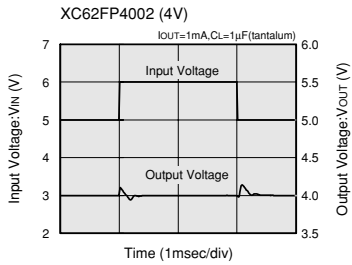
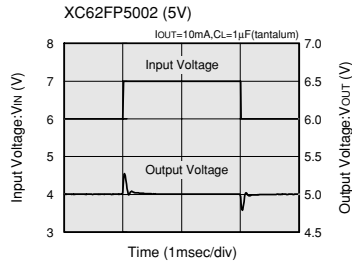
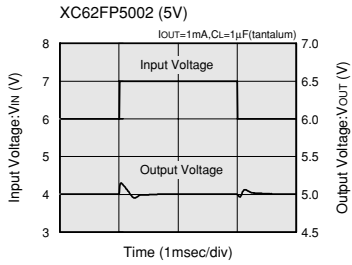

XC62FP Series

(9) LOAD TRANSIENT RESPONSE

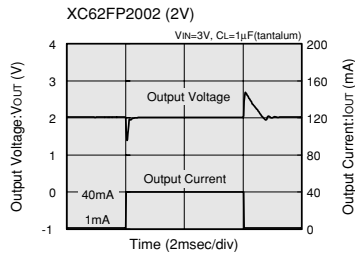
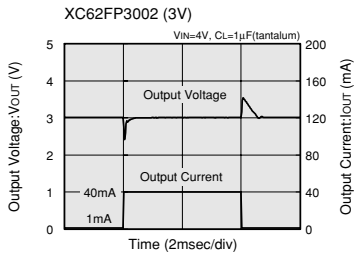
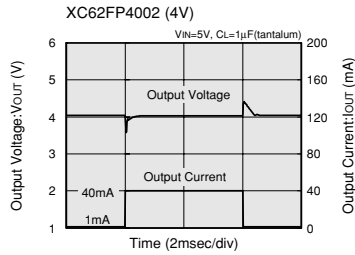
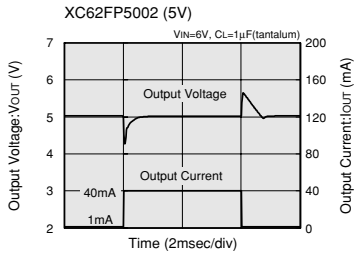

(10) RIPPLE REJECTION RATE

