

FEATURES

Laser-trimmed to high accuracy: 2.500 V \pm 0.4%
3-terminal device: voltage in/voltage out
Excellent temperature stability: 10 ppm/ $^{\circ}$ C (AD580M, U)
Excellent long-term stability: 250 μ V (25 μ V/month)
Low quiescent current: 1.5 mA maximum
Small, hermetic IC package: TO-52 can
MIL-STD-883 compliant versions available

GENERAL DESCRIPTION

The AD580¹ is a 3-terminal, low cost, temperature-compensated, bandgap voltage reference, which provides a fixed 2.5 V output for inputs between 4.5 V and 30 V. A unique combination of advanced circuit design and laser-wafer trimmed thin film resistors provide the AD580 with an initial tolerance of \pm 0.4%, a temperature stability of better than 10 ppm/ $^{\circ}$ C, and long-term stability of better than 250 μ V. In addition, the low quiescent current drain of 1.5 mA maximum offers a clear advantage over classical Zener techniques.

The AD580 is recommended as a stable reference for all 8-, 10-, and 12-bit D/A converters that require an external reference. In addition, the wide input range of the AD580 allows operation with 5 volt logic supplies, making the AD580 ideal for digital panel meter applications or whenever only a single logic power supply is available.

The AD580J, K, L, and M are specified for operation over the 0 $^{\circ}$ C to +70 $^{\circ}$ C temperature range; the AD580S, T, and U are specified for operation over the extended temperature range of -55 $^{\circ}$ C to +125 $^{\circ}$ C.

FUNCTIONAL BLOCK DIAGRAM

Figure 1.

PRODUCT HIGHLIGHTS

1. Laser-trimming of the thin film resistors minimizes the AD580 output error. For example, the AD580L output tolerance is \pm 10 mV.
2. The three-terminal voltage in/voltage out operation of the AD580 provides regulated output voltage without any external components.
3. The AD580 provides a stable 2.5 V output voltage for input voltages between 4.5 V and 30 V. The capability to provide a stable output voltage using a 5 V input makes the AD580 an ideal choice for systems that contain a single logic power supply.
4. Thin film resistor technology and tightly controlled bipolar processing provide the AD580 with temperature stabilities to 10 ppm/ $^{\circ}$ C and long-term stability better than 250 μ V.
5. The low quiescent current drain of the AD580 makes it ideal for CMOS and other low power applications.
6. The AD580 is available in versions compliant with MIL-STD-883. Refer to the Analog Devices Military Products Data Book or the current AD580/AD883B data sheet for detailed specifications.

¹ Protected by U.S. Patent Numbers 3,887,863; RE30,586.

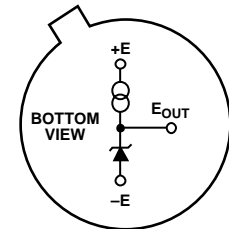
Rev. B

Information furnished by Analog Devices is believed to be accurate and reliable. However, no responsibility is assumed by Analog Devices for its use, nor for any infringements of patents or other rights of third parties that may result from its use. Specifications subject to change without notice. No license is granted by implication or otherwise under any patent or patent rights of Analog Devices. Trademarks and registered trademarks are the property of their respective owners.

TABLE OF CONTENTS

Specifications.....	3	The AD580 as a Current Limiter.....	6
Absolute Maximum Ratings.....	4	The AD580 as a Low Power, Low Voltage, Precision Reference for Data Converters.....	7
AD580 Chip Dimensions And Pad Layout.....	4	Outline Dimensions	8
ESD Caution.....	4	Ordering Guide	8
Theory of Operation	5		
Voltage Variation versus Temperature	5		
Noise Performance	6		

REVISION HISTORY

8/04—Changed from Rev. A to Rev. B

Updated Format..... Universal

SPECIFICATIONS

Table 1. $V_{IN} = 15\text{ V}$ and 25°C

Model	AD580J			AD580K			AD580L			AD580M			Units
	Min	Typ	Max	Min	Typ	Max	Min	Typ	Max	Min	Typ	Max	
OUTPUT VOLTAGE TOLERANCE Error from Nominal 2.500 V Output			±75			±25			±10			±10	mV
OUTPUT VOLTAGE CHANGE T_{MIN} to T_{MAX}			15 85			7 40			4.3 25			1.75 10	mV ppm/°C
LINE REGULATION $7\text{ V} \leq V_{IN} \leq 30\text{ V}$ $4.5\text{ V} \leq V_{IN} \leq 7\text{ V}$		1.5 0.3	6 ¹ 3		1.5 0.3	4 2		2 1			2 1		mV mV
LOAD REGULATION $\Delta I = 10\text{ mA}$			10			10			10			10	mV
QUIESCENT CURRENT		1.0	1.5		1.0	1.5		1.0	1.5		1.0	1.5	mA
NOISE (0.1 Hz to 10 Hz)		8			8			8			8		μV p-p
STABILITY Long Term Per Month		250 25			250 25			250 25			250 25		μV μV
TEMPERATURE PERFORMANCE Specified Operating Storage	0 -55 -65		+70 +125 +175	0 -55 -65		+70 +125 +175	0 -55 -65		+70 +125 +175	0 -55 -65		+70 +125 +175	°C °C °C
PACKAGE OPTION ² TO-52 (H-03A)		AD580JH			AD580KH			AD580LH			AD580MH		

Table 2.

Model	AD580S			AD580T			AD580U			Units
	Min	Typ	Max	Min	Typ	Max	Min	Typ	Max	
OUTPUT VOLTAGE TOLERANCE Error from Nominal 2.500 V Output			±25 ¹			±10			±10	mV
OUTPUT VOLTAGE CHANGE T_{MIN} to T_{MAX}			25 55			11 25			4.5 10	mV ppm/°C
LINE REGULATION $7\text{ V} \leq V_{IN} \leq 30\text{ V}$ $4.5\text{ V} \leq V_{IN} \leq 7\text{ V}$		1.5 0.3	6 3			2 1			2 1	mV mV
LOAD REGULATION $\Delta I = 10\text{ mA}$			10			10			10	mV
QUIESCENT CURRENT		1.0	1.5		1.0	1.5		1.0	1.5	mA
NOISE (0.1 Hz to 10 Hz)		8			8			8		μV p-p
STABILITY Long Term Per Month		250 25			250 25			250 25		μV μV
TEMPERATURE PERFORMANCE Specified Operating Storage	-55 -55 -65		+125 +150 +175	-55 -55 -65		+125 +150 +175	-55 -55 -65		+125 +150 +175	°C °C °C
PACKAGE OPTION ² TO-52 (H-03A)		AD580SH			AD580TH			AD580UH		

¹ Specifications shown in **boldface** are tested on all production units at final electrical test. Results from those tests are used to calculate outgoing quality levels. All min and max specifications are guaranteed, although only those shown in **boldface** are tested on all production units.

² H = Metal Can.

AD580

ABSOLUTE MAXIMUM RATINGS

Table 3.

Parameter	Rating
Input Voltage	40 V
Power Dissipation @ 25°C Ambient Temperature	350 mW
Derate above 25°C	2.8 mW/°C
Lead Temperature (Soldering 10 sec)	300°C
Thermal Resistance Junction-to-Case	100°C
Junction-to-Ambient	360°C/W

Stresses above those listed under Absolute Maximum Ratings may cause permanent damage to the device. This is a stress rating only; functional operation of the device at these or any other conditions above those listed in the operational sections of this specification is not implied. Exposure to absolute maximum rating conditions for extended periods may affect device reliability.

ESD CAUTION

ESD (electrostatic discharge) sensitive device. Electrostatic charges as high as 4000 V readily accumulate on the human body and test equipment and can discharge without detection. Although this product features proprietary ESD protection circuitry, permanent damage may occur on devices subjected to high energy electrostatic discharges. Therefore, proper ESD precautions are recommended to avoid performance degradation or loss of functionality.

AD580 CHIP DIMENSIONS AND PAD LAYOUT

Dimensions shown in inches and (millimeters).

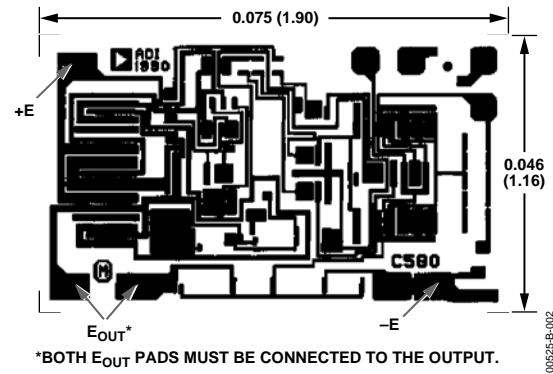

The AD580 is also available in chip form. Consult the factory for specifications and applications information.



THEORY OF OPERATION

The AD580 family (AD580, AD581, AD584, AD589) uses the bandgap concept to produce a stable, low temperature coefficient voltage reference suitable for high accuracy data acquisition components and systems. The device makes use of the underlying physical nature of a silicon transistor base-emitter voltage in the forward-biased operating region. All such transistors have approximately a $-2 \text{ mV}/^\circ\text{C}$ temperature coefficient, unsuitable for use directly as a low TC reference. Extrapolation of the temperature characteristic of any one of these devices to absolute zero (with an emitter current proportional to the absolute temperature), however, reveals that it will go to a V_{BE} of 1.205 V at 0 K , as shown in Figure 3. Thus, if a voltage could be developed with an opposing temperature coefficient to sum with V_{BE} to total 1.205 V , a 0 TC reference would result and operation from a single, low voltage supply would be possible. The AD580 circuit provides such a compensating voltage, V_1 in Figure 4, by driving two transistors at different current densities and amplifying the resulting V_{BE} difference (ΔV_{BE} —which now has a positive TC). The sum, V_Z , is then buffered and amplified up to 2.5 V to provide a usable reference-voltage output. Figure 5 shows the schematic diagram of the AD580.

The AD580 operates as a 3-terminal reference, meaning that no additional components are required for biasing or current setting. The connection diagram, Figure 6, is quite simple.

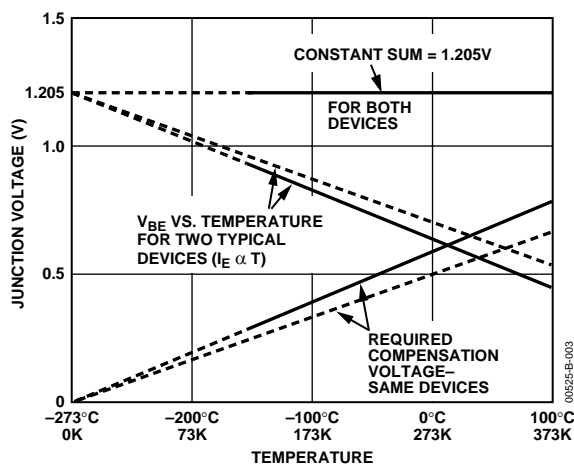

Figure 3. Extrapolated Variation of Base-Emitter Voltage with Temperature ($I_E \propto T$), and Required Compensation, Shown for Two Different Devices

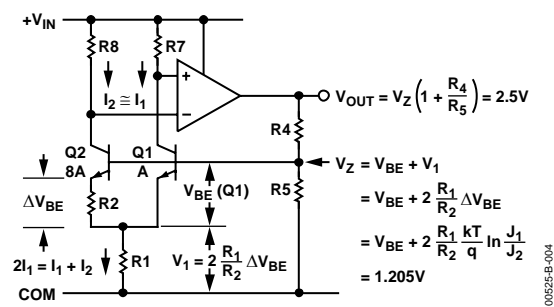

Figure 4. Basic Bandgap-Reference Regulator Circuit

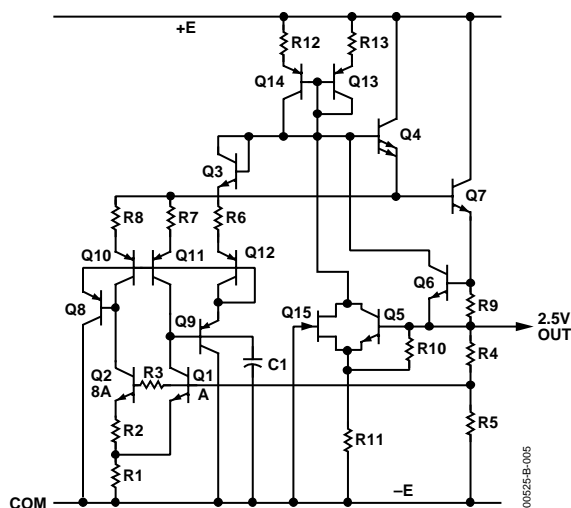

Figure 5. Schematic Diagram

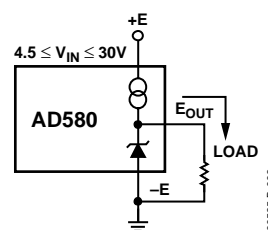

Figure 6. Connection Diagram

VOLTAGE VARIATION VERSUS TEMPERATURE

Some confusion exists in the area of defining and specifying reference voltage error over temperature. Historically, references are characterized using a maximum deviation per degree Centigrade; i.e., $10 \text{ ppm}/^\circ\text{C}$. However, because of the inconsistent nonlinearities in Zener references (butterfly or S type characteristics), most manufacturers use a maximum limit error band approach to characterize their references. This technique measures the output voltage at 3 to 5 different temperatures and guarantees that the output voltage deviation will fall within the guaranteed error band at these discrete temperatures. This approach, of course, makes no mention or guarantee of performance at any other temperature within the operating temperature range of the device.

AD580

The consistent voltage versus temperature performance of a typical AD580 is shown in Figure 7. Note that the characteristic is quasi-parabolic, not the possible S type characteristics of classical Zener references. This parabolic characteristic permits a maximum output deviation specification over the device's full operating temperature range, rather than just at 3 to 5 discrete temperatures.

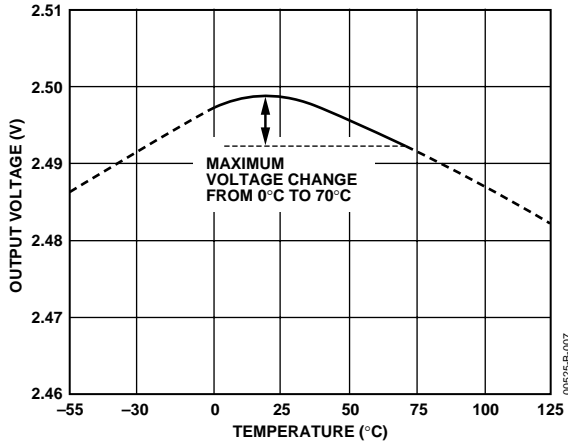

Figure 7. Typical AD580K Output Voltage vs. Temperature

The AD580M guarantees a maximum deviation of 1.75 mV over the 0°C to 70°C temperature range. This can be shown to be equivalent to 10 ppm/°C average maximum; i.e.,

$$\frac{1.75 \text{ mV max}}{70^\circ\text{C}} \times \frac{1}{2.5\text{V}} = 10 \text{ ppm}/^\circ\text{C max average}$$

The AD580 typically exhibits a variation of 1.5 mV over the power supply range of 7 V to 30 V. Figure 8 is a plot of AD580 line rejection versus frequency.

NOISE PERFORMANCE

Figure 9 represents the peak-to-peak noise of the AD580 from 1 Hz (3 dB point) to a 3 dB high end shown on the horizontal axis. Peak-to-peak noise from 1 Hz to 1 MHz is approximately 600 μV.

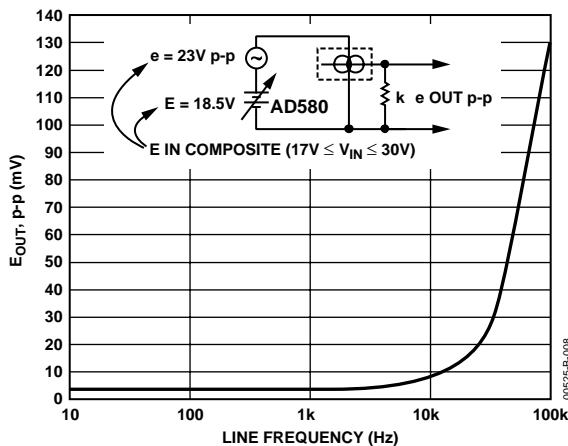

Figure 8. AD580 Line Rejection Plot

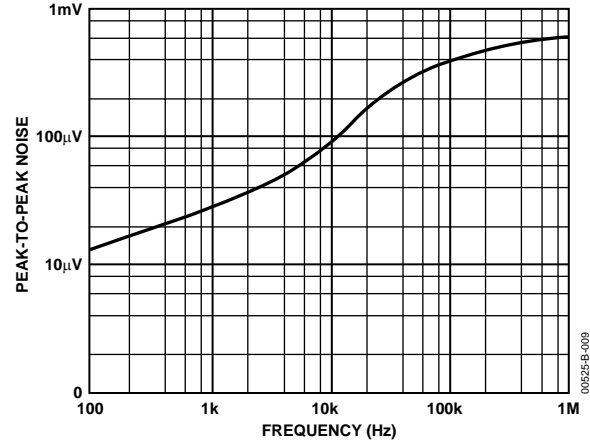

Figure 9. Peak-to-Peak Output Noise vs. Frequency

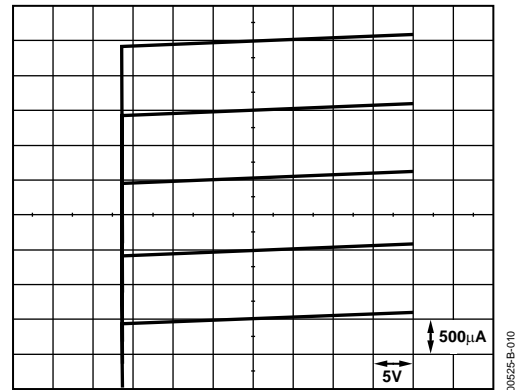

Figure 10. Input Current vs. Input Voltage (Integral Loads)

THE AD580 AS A CURRENT LIMITER

The AD580 represents an excellent alternative to current limiter diodes that require factory selection to achieve a desired current. This approach often results in temperature coefficients of 1%/C. The AD580 approach is not limited to a specially selected factory set current limit; it can be programmed from 1 mA to 10 mA with the insertion of a single external resistor. The approximate temperature coefficient of current limit for the AD580 used in this mode is 0.13%/°C for $I_{LIM} = 1 \text{ mA}$ and 0.01%/°C for $I_{LIM} = 13 \text{ mA}$ (see Figure 11). Figure 10 displays the high output impedance of the AD580 used as a current limiter for $I_{LIM} = 1, 2, 3, 4,$ and 5 mA .

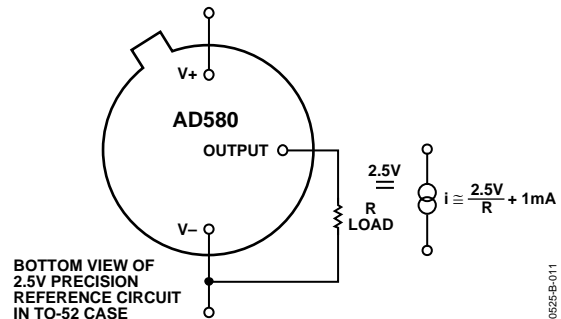

Figure 11. A Two-Component Precision Current Limiter

THE AD580 AS A LOW POWER, LOW VOLTAGE, PRECISION REFERENCE FOR DATA CONVERTERS

The AD580 has a number of features that make it ideally suited for use with A/D and D/A data converters used in complex microprocessor-based systems. The calibrated 2.500 V output minimizes user trim requirements and allows operation from a single, low voltage supply. Low power consumption (1 mA quiescent current) is commensurate with that of CMOS-type devices, while the low cost and small package complements the decreasing cost and size of the latest converters.

Figure 12 shows the AD580 used as a reference for the AD7542 12-bit CMOS DAC with complete microprocessor interface. The AD580 and the AD7542 are specified to operate from a single 5 V supply, thus eliminating the need to provide a 15 V power supply for the sole purpose of operating a reference. The AD7542 includes three 4-bit data registers, a 12-bit DAC register, and address decoding logic. It may thus be interfaced directly to a 4-, 8- or 16-bit data bus. Only 8 mA of quiescent current from the single 5 volt supply is required to operate the AD7542 which is packaged in a small, 16-pin DIP. The AD580

output amplifier is also low power, requiring only 2.5 mA quiescent current. Its laser-trimmed offset voltage preserves the $\pm 1/2$ LSB linearity of the AD7542KN without user trims, and it typically settles to $\pm 1/2$ LSB in less than 3 μ s. It will provide the 0 V to -2.5 V output swing from ± 5 V supplies.

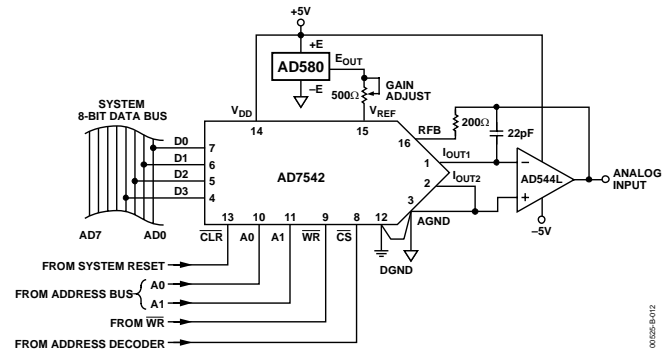
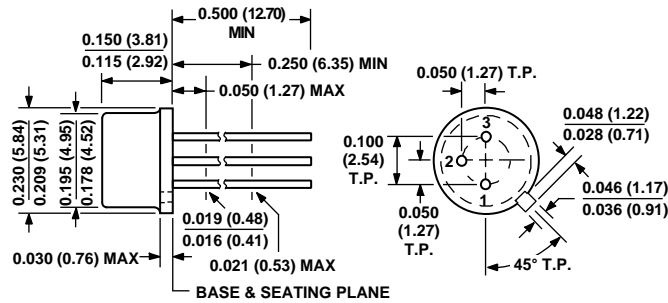

Figure 12. Low Power, Low Voltage Reference for the AD7542 Microprocessor-Compatible, 12-Bit DAC

OUTLINE DIMENSIONS



CONTROLLING DIMENSIONS ARE IN INCHES; MILLIMETERS DIMENSIONS (IN PARENTHESES) ARE ROUNDED-OFF INCH EQUIVALENTS FOR REFERENCE ONLY AND ARE NOT APPROPRIATE FOR USE IN DESIGN

Figure 13. TO-52 Package
Dimensions shown in inches and (millimeters)

ORDERING GUIDE

Model	Output Voltage Tolerance	Temperature Coefficient	Operating Temperature Range	Package Option	Package Description
AD580JH	±75 mV	85 ppm/°C	-55°C to +125°C	TO-52	H (Metal Can)
AD580KH	±25 mV	40 ppm/°C	-55°C to +125°C	TO-52	H (Metal Can)
AD580LH	±10 mV	25 ppm/°C	-55°C to +125°C	TO-52	H (Metal Can)
AD580LMH	±10 mV	10 ppm/°C	-55°C to +125°C	TO-52	H (Metal Can)
AD580SH	±25 mV	55 ppm/°C	-55°C to +125°C	TO-52	H (Metal Can)
AD580SH/883B	±25 mV	55 ppm/°C	-55°C to +125°C	TO-52	H (Metal Can)
AD580TH	±10 mV	25 ppm/°C	-55°C to +125°C	TO-52	H (Metal Can)
AD580UH	±10 mV	10 ppm/°C	-55°C to +125°C	TO-52	H (Metal Can)
AD580UH/883B	±10 mV	10 ppm/°C	-55°C to +125°C	TO-52	H (Metal Can)
AD580TCHIPS	±10 mV			DIE	