

128Mbit GDDR SDRAM

*2M x 16Bit x 4 Banks
Graphic Double Data Rate
Synchronous DRAM*

Revision 1.2

January 2004

Samsung Electronics reserves the right to change products or specification without notice.

Revision History**Revision 1.2 (January 30, 2004)**

- Changed tWR & tWR_A of K4D261638F-TC25/2A/33/36 from 3tCK to 4tCK
- Changed tRC of K4D261638F-TC25 from 17tCK to 18tCK
- Changed tRC of K4D261638F-TC2A/33/36 from 15tCK to 16tCK
- Changed tRAS of K4D261638F-TC25 from 12tCK to 13tCK.
- Changed tRAS of K4D261638F-TC2A/33/36 from 10tCK to 11tCK.
- Changed tDAL of K4D261638F-TC25/2A/33/36 from 8tCK to 9tCK

Revision 1.1 (January 7, 2004)

- Added K4D261638F-TC25 in the spec.

Revision 1.0 (December 5, 2003)**Revision 0.9 (October 14, 2003) - *Preliminary Spec***

- Defined DC spec

Revision 0.1 (October 2, 2003) - *Target Spec*

- Added Lead free package part number in the datasheet

Revision 0.0 (August 6, 2003) - *Target Spec*

- Defined Target Specification

2M x 16Bit x 4 Banks Graphic Double Data Rate Synchronous DRAM with Bi-directional Data Strobe and DLL

FEATURES

- 2.5V \pm 5% power supply for device operation
- 2.5V \pm 5% power supply for I/O interface
- SSTL_2 compatible inputs/outputs
- 4 banks operation
- MRS cycle with address key programs
 - . Read latency 3, 4 and 5(clock)
 - . Burst length (2, 4 and 8)
 - . Burst type (sequential & interleave)
- All inputs except data & DM are sampled at the positive going edge of the system clock
- Differential clock input
- No Write-Interrupted by Read Function
- 2 DQS's (1DQS / Byte)
- Data I/O transactions on both edges of Data strobe
- DLL aligns DQ and DQS transitions with Clock transition
- Edge aligned data & data strobe output
- Center aligned data & data strobe input
- DM for write masking only
- Auto & Self refresh
- 32ms refresh period (4K cycle)
- 66pin TSOP-II
- Maximum clock frequency up to 400MHz
- Maximum data rate up to 800Mbps/pin

ORDERING INFORMATION

Part NO.	Max Freq.	Max Data Rate	Interface	Package
K4D261638F-TC25	400MHz	800Mbps/pin	SSTL_2	66pin TSOP-II
K4D261638F-TC2A	350MHz	700Mbps/pin		
K4D261638F-TC33	300MHz	600Mbps/pin		
K4D261638F-TC36	275MHz	550Mbps/pin		
K4D261638F-TC40	250MHz	500Mbps/pin		
K4D261638F-TC50	200MHz	400Mbps/pin		

K4D261638F-LC is the Lead Free package part number.
For the K4D261638F-TC25/2A, VDD & VDDQ = 2.8V \pm 0.1V

GENERAL DESCRIPTION

FOR 2M x 16Bit x 4 Bank DDR SDRAM

The K4D261638F is 134,217,728 bits of hyper synchronous data rate Dynamic RAM organized as 4 x 2,097,152 words by 16 bits, fabricated with SAMSUNG's high performance CMOS technology. Synchronous features with Data Strobe allow extremely high performance up to 1.6GB/s/chip. I/O transactions are possible on both edges of the clock cycle. Range of operating frequencies, programmable burst length and programmable latencies allow the device to be useful for a variety of high performance memory system applications.

PIN CONFIGURATION (Top View)

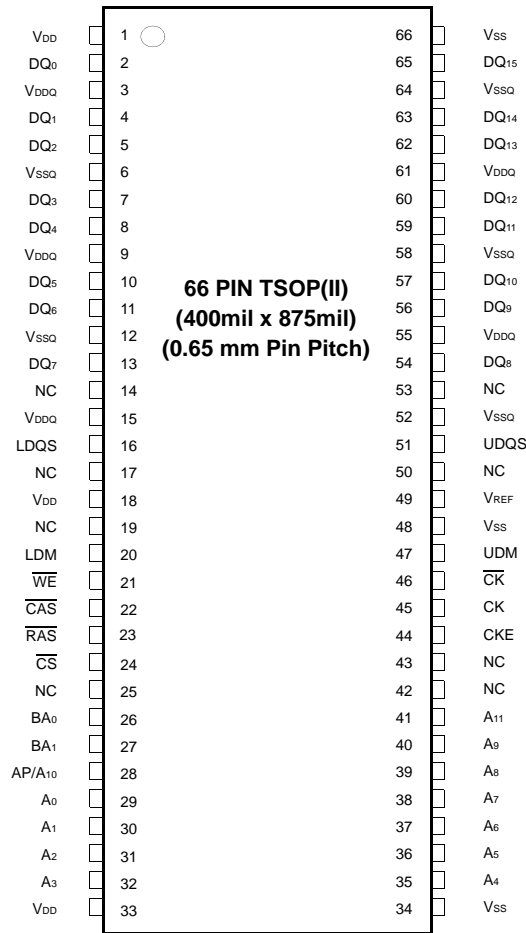

PIN DESCRIPTION

CK, \overline{CK}	Differential Clock Input	BA0, BA1	Bank Select Address
CKE	Clock Enable	A0 ~A11	Address Input
\overline{CS}	Chip Select	DQ0 ~ DQ15	Data Input/Output
\overline{RAS}	Row Address Strobe	VDD	Power
\overline{CAS}	Column Address Strobe	VSS	Ground
WE	Write Enable	VDDQ	Power for DQ's
L(U)DQS	Data Strobe	VSSQ	Ground for DQ's
L(U)DM	Data Mask	NC	No Connection
RFU	Reserved for Future Use		

INPUT/OUTPUT FUNCTIONAL DESCRIPTION

Symbol	Type	Function
CK, \overline{CK}^*1	Input	The differential system clock Input. All of the inputs are sampled on the rising edge of the clock except DQ's and DM's that are sampled on both edges of the DQS.
CKE	Input	Activates the CK signal when high and deactivates the \overline{CK} signal when low. By deactivating the clock, CKE low indicates the Power down mode or Self refresh mode.
\overline{CS}	Input	\overline{CS} enables the command decoder when low and disabled the command decoder when high. When the command decoder is disabled, new commands are ignored but previous operations continue.
\overline{RAS}	Input	Latches row addresses on the positive going edge of the CK with \overline{RAS} low. Enables row access & precharge.
\overline{CAS}	Input	Latches column addresses on the positive going edge of the CK with \overline{CAS} low. Enables column access.
\overline{WE}	Input	Enables write operation and row precharge. Latches data in starting from \overline{CAS} , \overline{WE} active.
LDQS, UDQS	Input/Output	Data input and output are synchronized with both edge of DQS. For the x16, LDQS corresponds to the data on DQ0-DQ7 ; UDQS corresponds to the data on DQ8-DQ15.
LDM, UDM	Input	Data in Mask. Data In is masked by DM Latency=0 when DM is high in burst write. For the x16, LDM corresponds to the data on DQ0-DQ7 ; UDM corresponds to the data on DQ8-DQ15.
DQ0 ~ DQ15	Input/Output	Data inputs/Outputs are multiplexed on the same pins.
BA0, BA1	Input	Selects which bank is to be active.
A0 ~ A11	Input	Row/Column addresses are multiplexed on the same pins. Row addresses : RA0 ~ RA11, Column addresses : CA0 ~ CA8.
VDD/VSS	Power Supply	Power and ground for the input buffers and core logic.
VDDQ/VSSQ	Power Supply	Isolated power supply and ground for the output buffers to provide improved noise immunity.
VREF	Power Supply	Reference voltage for inputs, used for SSTL interface.
NC/RFU	No connection/ Reserved for future use	This pin is recommended to be left "No connection" on the device

*1 : The timing reference point for the differential clocking is the cross point of CK and \overline{CK} .

For any applications using the single ended clocking, apply VREF to \overline{CK} pin.

BLOCK DIAGRAM (2Mbit x 16I/O x 4 Bank)

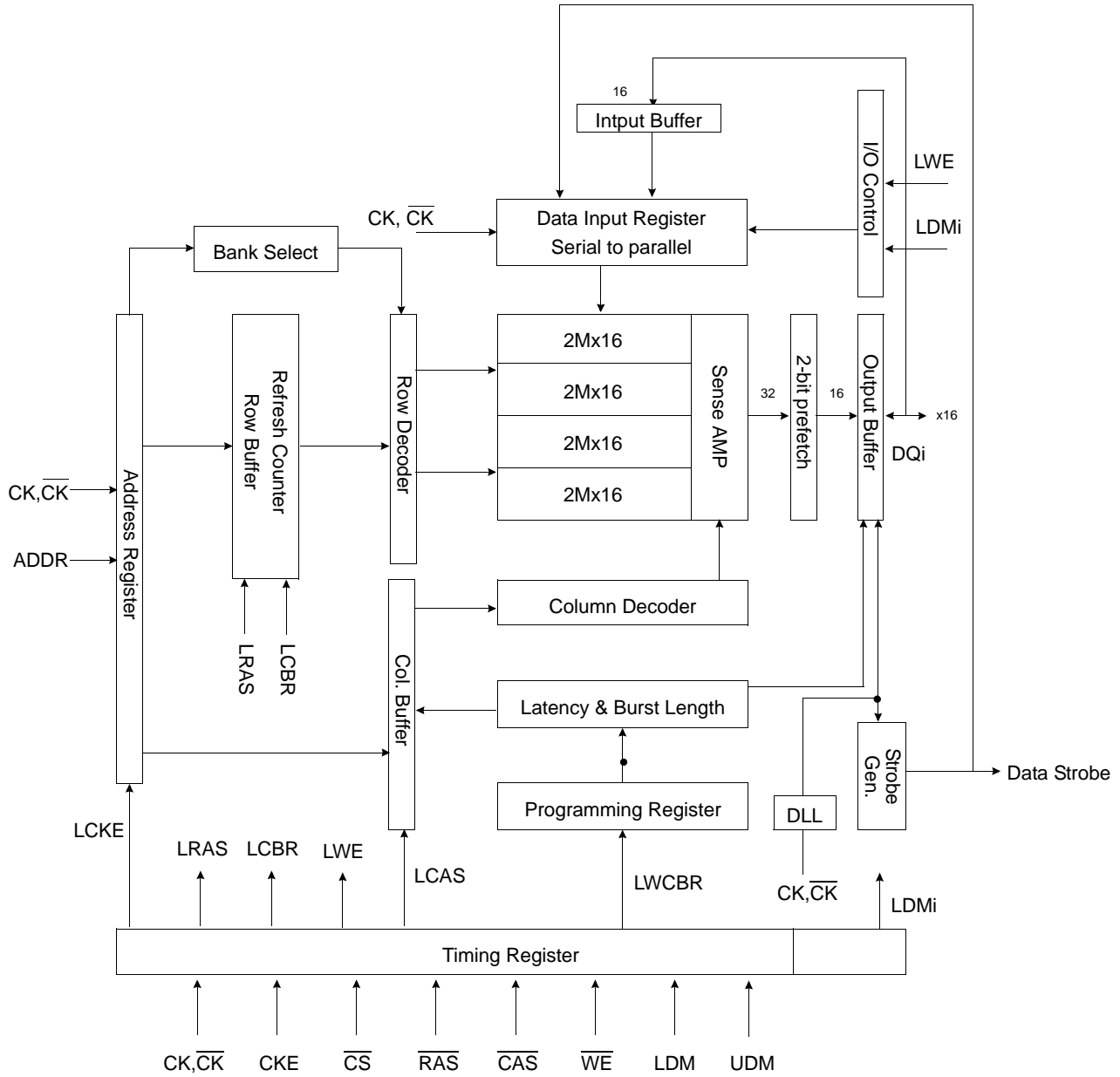

FUNCTIONAL DESCRIPTION

• **Power-Up Sequence**

DDR SDRAMs must be powered up and initialized in a predefined manner to prevent undefined operations.

1. Apply power and keep CKE at low state (All other inputs may be undefined)
 - Apply VDD before VDDQ .
 - Apply VDDQ before VREF & VTT
2. Start clock and maintain stable condition for minimum 200us.
3. The minimum of 200us after stable power and clock(CK,CK⁻), apply NOP and take CKE to be high .
4. Issue precharge command for all banks of the device.
5. Issue a EMRS command to enable DLL
- *1 6. Issue a MRS command to reset DLL. The additional 200 clock cycles are required to lock the DLL.
- *1,2 7. Issue precharge command for all banks of the device.
8. Issue at least 2 or more auto-refresh commands.
9. Issue a mode register set command with A8 to low to initialize the mode register.

*1 The additional 200cycles of clock input is required to lock the DLL after enabling DLL.
 *2 Sequence of 6&7 is regardless of the order.

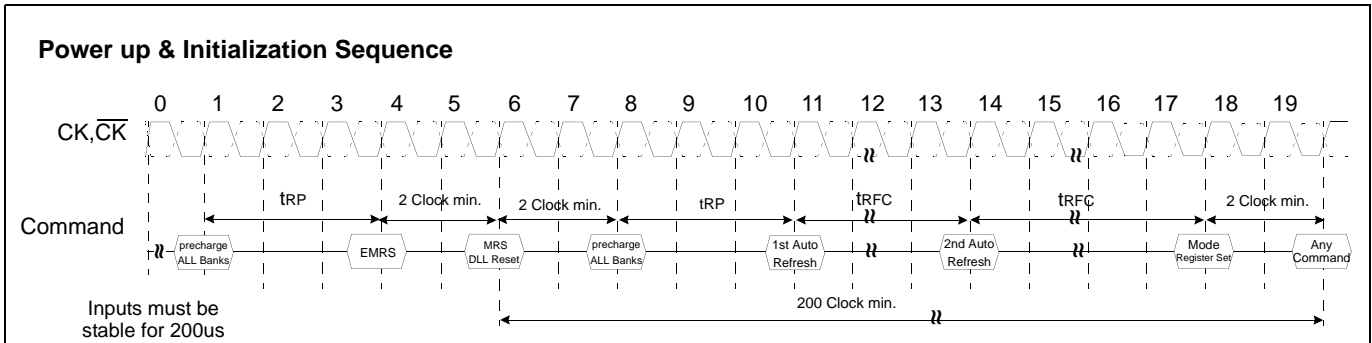

* When the operating frequency is changed, DLL reset should be required again.
 After DLL reset again, the minimum 200 cycles of clock input is needed to lock the DLL.

MODE REGISTER SET(MRS)

The mode register stores the data for controlling the various operating modes of DDR SDRAM. It programs CAS latency, addressing mode, burst length, test mode, DLL reset and various vendor specific options to make DDR SDRAM useful for variety of different applications. The default value of the mode register is not defined, therefore the mode register must be written after EMRS setting for proper operation. The mode register is written by asserting low on CS, RAS, CAS and WE(The DDR SDRAM should be in active mode with CKE already high prior to writing into the mode register). The state of address pins A0 ~ A11 and BA0, BA1 in the same cycle as CS, RAS, CAS and WE going low is written in the mode register. Minimum two clock cycles are requested to complete the write operation in the mode register. The mode register contents can be changed using the same command and clock cycle requirements during operation as long as all banks are in the idle state. The mode register is divided into various fields depending on functionality. The burst length uses A0 ~ A2, addressing mode uses A3, CAS latency(read latency from column address) uses A4 ~ A6. A7 is used for test mode. A8 is used for DLL reset. A7,A8, BA0 and BA1 must be set to low for normal MRS operation. Refer to the table for specific codes for various burst length, addressing modes and CAS latencies.

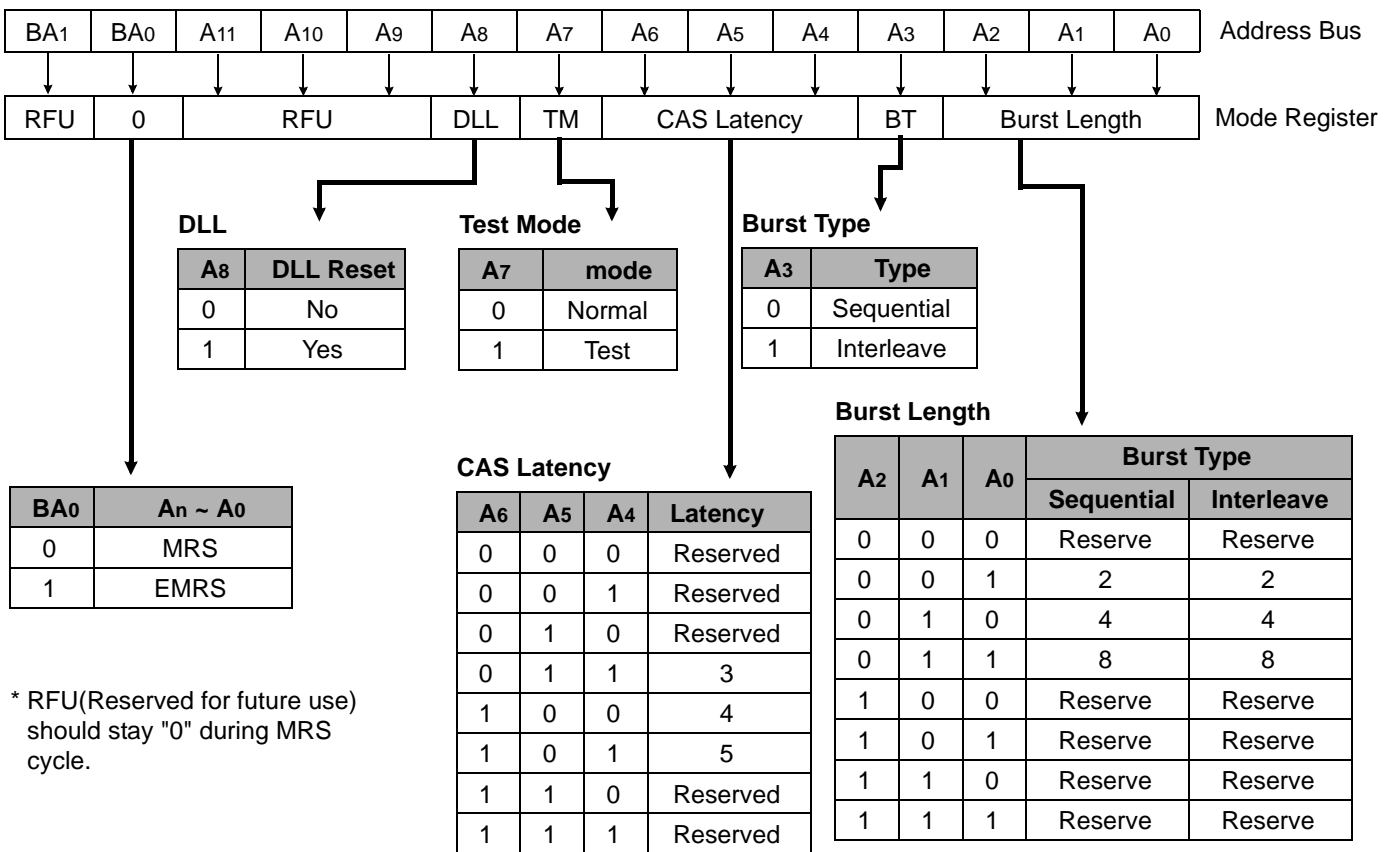

* RFU(Reserved for future use) should stay "0" during MRS cycle.

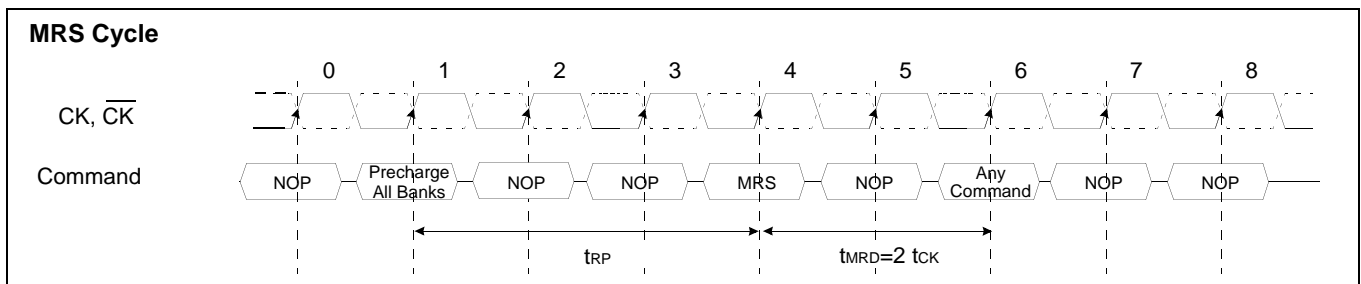

*1 : MRS can be issued only at all banks precharge state.
 *2 : Minimum tRP is required to issue MRS command.

EXTENDED MODE REGISTER SET(EMRS)

The extended mode register stores the data for enabling or disabling DLL and selecting output driver strength. The default value of the extended mode register is not defined, therefore the extended mode register must be written after power up for enabling or disabling DLL. The extended mode register is written by asserting low on \overline{CS} , \overline{RAS} , \overline{CAS} , \overline{WE} and high on BA0(The DDR SDRAM should be in all bank precharge with CKE already high prior to writing into the extended mode register). The state of address pins A0, A2 ~ A5, A7 ~ A11 and BA1 in the same cycle as \overline{CS} , \overline{RAS} , \overline{CAS} and \overline{WE} going low are written in the extended mode register. A1 and A6 are used for setting driver strength to normal, weak or matched impedance. Two clock cycles are required to complete the write operation in the extended mode register. The mode register contents can be changed using the same command and clock cycle requirements during operation as long as all banks are in the idle state. A0 is used for DLL enable or disable. "High" on BA0 is used for EMRS. All the other address pins except A0,A1,A6 and BA0 must be set to low for proper EMRS operation. Refer to the table for specific codes.

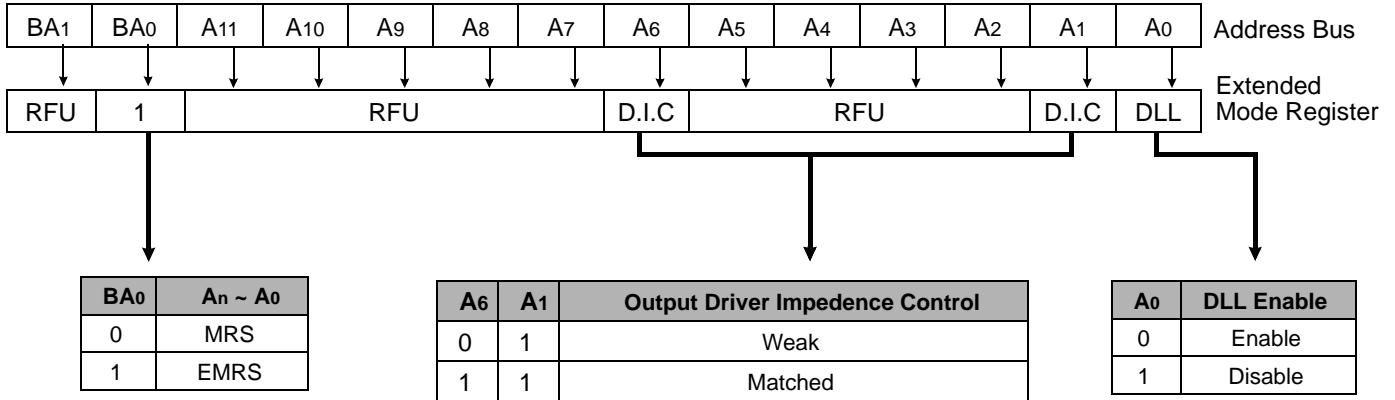

*1 : RFU(Reserved for future use) should stay "0" during EMRS cycle.

ABSOLUTE MAXIMUM RATINGS

Parameter	Symbol	Value	Unit
Voltage on any pin relative to Vss	V _{IN} , V _{OUT}	-0.5 ~ 3.6	V
Voltage on VDD supply relative to Vss	VDD	-1.0 ~ 3.6	V
Voltage on VDDQ supply relative to Vss	VDDQ	-0.5 ~ 3.6	V
Storage temperature	T _{STG}	-55 ~ +150	°C
Power dissipation	PD	2.0	W
Short circuit current	I _{OS}	50	mA

Note : Permanent device damage may occur if ABSOLUTE MAXIMUM RATINGS are exceeded.
Functional operation should be restricted to recommended operating condition.
Exposure to higher than recommended voltage for extended periods of time could affect device reliability.

POWER & DC OPERATING CONDITIONS(SSTL_2 In/Out)

Recommended operating conditions(Voltage referenced to Vss=0V, T_A=0 to 65°C)

Parameter	Symbol	Min	Typ	Max	Unit	Note
Device Supply voltage	VDD	2.375	2.50	2.625	V	1, 7
Output Supply voltage	VDDQ	2.375	2.50	2.625	V	1, 7
Reference voltage	VREF	0.49*VDDQ	-	0.51*VDDQ	V	2
Termination voltage	V _{tt}	VREF-0.04	VREF	VREF+0.04	V	3
Input logic high voltage	V _{IH} (DC)	VREF+0.15	-	VDDQ+0.30	V	4
Input logic low voltage	V _{IL} (DC)	-0.30	-	VREF-0.15	V	5
Output logic high voltage	V _{OH}	V _{tt} +0.76	-	-	V	I _{OH} =-15.2mA
Output logic low voltage	V _{OL}	-	-	V _{tt} -0.76	V	I _{OL} =+15.2mA
Input leakage current	I _{IL}	-5	-	5	uA	6
Output leakage current	I _{OL}	-5	-	5	uA	6

- Note :**
- Under all conditions VDDQ must be less than or equal to VDD.
 - VREF is expected to equal 0.50*VDDQ of the transmitting device and to track variations in the DC level of the same. Peak to peak noise on the VREF may not exceed + 2% of the DC value. Thus, from 0.50*VDDQ, VREF is allowed + 25mV for DC error and an additional + 25mV for AC noise.
 - V_{tt} of the transmitting device must track VREF of the receiving device.
 - V_{IH}(max.)= VDDQ +1.5V for a pulse width and it can not be greater than 1/3 of the cycle rate.
 - V_{IL}(min.)= -1.5V for a pulse width and it can not be greater than 1/3 of the cycle rate.
 - For any pin under test input of 0V ≤ V_{IN} ≤ VDD is acceptable. For all other pins that are not under test V_{IN}=0V.
 - For the K4D261638F-TC25/2A, VDD & VDDQ = 2.8V±0.1V**

DC CHARACTERISTICS

Recommended operating conditions Unless Otherwise Noted, TA=0 to 65°C)

Parameter	Symbol	Test Condition	Version						Unit	Note
			-25	-2A	-33	-36	-40	-50		
Operating Current (One Bank Active)	I _{CC1}	Burst Lenth=2 trc ≥ trc(min) IoL=0mA, tcc= tcc(min)	TBD	210	190	180	170	150	mA	1
Precharge Standby Current in Power-down mode	I _{CC2P}	CKE ≤ V _{IL} (max), tcc= tcc(min)	TBD	60	45				mA	
Precharge Standby Current in Non Power-down mode	I _{CC2N}	CKE ≥ V _{IH} (min), CS ≥ V _{IH} (min), tcc= tcc(min)	TBD	90	75	70	65	60	mA	
Active Standby Current power-down mode	I _{CC3P}	CKE ≤ V _{IL} (max), tcc= tcc(min)	TBD	75	65	60	55	50	mA	
Active Standby Current in in Non Power-down mode	I _{CC3N}	CKE ≥ V _{IH} (min), CS ≥ V _{IH} (min), tcc= tcc(min)	TBD	135	100	100	95	90	mA	
Operating Current (Burst Mode)	I _{CC4}	trc ≥ trFC(min)trc ≥ trFC(min) Page Burst, All Banks activated.	TBD	400	290	275	260	245	mA	
Refresh Current	I _{CC5}	trc ≥ trFC(min)	TBD	245	210	200	195	190	mA	2
Self Refresh Current	I _{CC6}	CKE ≤ 0.2V	4						mA	

- Note** : 1. Measured with outputs open.
2. Refresh period is 32ms.

AC INPUT OPERATING CONDITIONS

Recommended operating conditions(Voltage referenced to V_{SS}=0V, V_{DD}=2.5V±5%, V_{DDQ}=2.5V±5%,TA=0 to 65°C)

Parameter	Symbol	Min	Typ	Max	Unit	Note
Input High (Logic 1) Voltage; DQ	V _{IH}	V _{REF} +0.35	-	-	V	
Input Low (Logic 0) Voltage; DQ	V _{IL}	-	-	V _{REF} -0.35	V	
Clock Input Differential Voltage; CK and $\overline{\text{CK}}$	V _{ID}	0.7	-	V _{DDQ} +0.6	V	1
Clock Input Crossing Point Voltage; CK and $\overline{\text{CK}}$	V _{IX}	0.5*V _{DDQ} -0.2	-	0.5*V _{DDQ} +0.2	V	2

- Note** : 1. V_{ID} is the magnitude of the difference between the input level on CK and the input level on $\overline{\text{CK}}$
2. The value of V_{IX} is expected to equal 0.5*V_{DDQ} of the transmitting device and must track variations in the DC level of the same
3. For the K4D261638F-TC25/2A, V_{DD} & V_{DDQ} = 2.8V±0.1V.

AC OPERATING TEST CONDITIONS ($V_{DD}=2.5V\pm 5\%$, $T_A= 0$ to $65^\circ C$)

Parameter	Value	Unit	Note
Input reference voltage for CK(for single ended)	$0.50 \cdot V_{DDQ}$	V	
CK and \overline{CK} signal maximum peak swing	1.5	V	
CK signal minimum slew rate	1.0	V/ns	
Input Levels(V_{IH}/V_{IL})	$V_{REF}+0.35/V_{REF}-0.35$	V	
Input timing measurement reference level	V_{REF}	V	
Output timing measurement reference level	V_{tt}	V	
Output load condition	See Fig.1		

1.For the K4D261638F-TC25/2A, V_{DD} & $V_{DDQ} = 2.8V\pm 0.1V$.

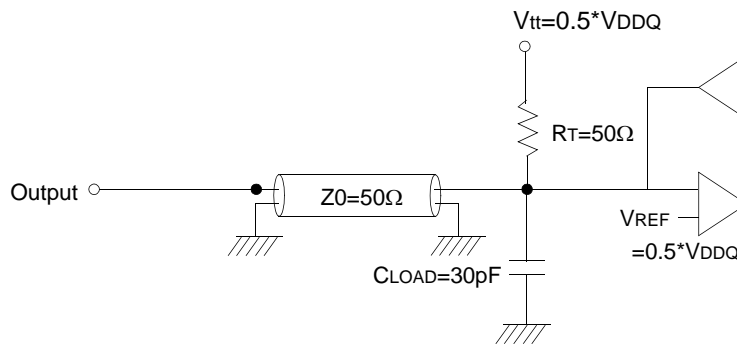

(Fig. 1) Output Load Circuit

CAPACITANCE ($V_{DD}=2.5V$, $T_A= 25^\circ C$, $f=1MHz$)

Parameter	Symbol	Min	Max	Unit
Input capacitance(CK, \overline{CK})	C_{IN1}	1.0	5.0	pF
Input capacitance($A_0\sim A_{11}$, $BA_0\sim BA_1$)	C_{IN2}	1.0	4.0	pF
Input capacitance (CKE, \overline{CS} , RAS, \overline{CAS} , WE)	C_{IN3}	1.0	4.0	pF
Data & DQS input/output capacitance(DQ0~DQ15)	C_{OUT}	1.0	6.5	pF
Input capacitance(DM0 ~ DM3)	C_{IN4}	1.0	6.5	pF

DECOUPLING CAPACITANCE GUIDE LINE

Recommended decoupling capacitance added to power line at board.

Parameter	Symbol	Value	Unit
Decoupling Capacitance between V_{DD} and V_{SS}	C_{DC1}	$0.1 + 0.01$	μF
Decoupling Capacitance between V_{DDQ} and V_{SSQ}	C_{DC2}	$0.1 + 0.01$	μF

- Note :**
- V_{DD} and V_{DDQ} pins are separated each other.
All V_{DD} pins are connected in chip. All V_{DDQ} pins are connected in chip.
 - V_{SS} and V_{SSQ} pins are separated each other
All V_{SS} pins are connected in chip. All V_{SSQ} pins are connected in chip.

AC CHARACTERISTICS - 1

Parameter	Symbol	-25		-2A		-33		Unit	Note
		Min	Max	Min	Max	Min	Max		
CK cycle time	CL=3	-	4	-	10	-	10	ns	
	CL=4	-		2.86		3.3		ns	
	CL=5	2.5						ns	
CK high level width	tCH	0.45	0.55	0.45	0.55	0.45	0.55	tCK	
CK low level width	tCL	0.45	0.55	0.45	0.55	0.45	0.55	tCK	
DQS out access time from CK	tDQSCK	-0.55	0.55	-0.6	0.6	-0.6	0.6	ns	
Output access time from CK	tAC	-0.55	0.55	-0.6	0.6	-0.6	0.6	ns	
Data strobe edge to Dout edge	tDQSQ	-	0.35	-	0.35	-	0.35	ns	1
Read preamble	tRPRE	0.9	1.1	0.9	1.1	0.9	1.1	tCK	
Read postamble	tRPST	0.4	0.6	0.4	0.6	0.4	0.6	tCK	
CK to valid DQS-in	tDQSS	0.85	1.15	0.85	1.15	0.85	1.15	tCK	
DQS-In setup time	tWPRES	0	-	0	-	0	-	ns	
DQS-in hold time	tWPREH	0.35	-	0.35	-	0.35	-	tCK	
DQS write postamble	tWPST	0.4	0.6	0.4	0.6	0.4	0.6	tCK	
DQS-In high level width	tDQSH	0.45	0.55	0.4	0.6	0.4	0.6	tCK	
DQS-In low level width	tDQSL	0.45	0.55	0.4	0.6	0.4	0.6	tCK	
Address and Control input setup	tIS	0.8	-	0.9	-	0.9	-	ns	
Address and Control input hold	tIH	0.8	-	0.9	-	0.9	-	ns	
DQ and DM setup time to DQS	tDS	0.35	-	0.35	-	0.35	-	ns	
DQ and DM hold time to DQS	tDH	0.35	-	0.35	-	0.35	-	ns	
Clock half period	tHP	tCLmin or tCHmin	-	tCLmin or tCHmin	-	tCLmin or tCHmin	-	ns	1
Data output hold time from DQS	tQH	tHP-0.4	-	tHP-0.35	-	tHP-0.35	-	ns	1

Note 1 :

- The JEDEC DDR specification currently defines the output data valid window(tDV) as the time period when the data strobe and all data associated with that data strobe are coincidentally valid.
- The previously used definition of tDV(=0.35tCK) artificially penalizes system timing budgets by assuming the worst case output valid window even then the clock duty cycle applied to the device is better than 45/55%
- A new AC timing term, tQH which stands for data output hold time from DQS is defined to account for clock duty cycle variation and replaces tDV
- tQHmin = tHP-X where
 - . tHP=Minimum half clock period for any given cycle and is defined by clock high or clock low time(tCH,tCL)
 - . X=A frequency dependent timing allowance account for tDQSQmax

AC CHARACTERISTICS - 2

Parameter	Symbol	-36		-40		-50		Unit	Note
		Min	Max	Min	Max	Min	Max		
CK cycle time	tCK	-	10	4.0	10	5.0	10	ns	
		3.6		-		-		ns	
		-		-		-		ns	
CK high level width	tCH	0.45	0.55	0.45	0.55	0.45	0.55	tCK	
CK low level width	tCL	0.45	0.55	0.45	0.55	0.45	0.55	tCK	
DQS out access time from CK	tDQSCK	-0.6	0.6	-0.6	0.6	-0.7	0.7	ns	
Output access time from CK	tAC	-0.6	0.6	-0.6	0.6	-0.7	0.7	ns	
Data strobe edge to Dout edge	tDQSQ	-	0.40	-	0.4	-	0.45	ns	1
Read preamble	tRPRE	0.9	1.1	0.9	1.1	0.9	1.1	tCK	
Read postamble	tRPST	0.4	0.6	0.4	0.6	0.4	0.6	tCK	
CK to valid DQS-in	tDQSS	0.85	1.15	0.85	1.15	0.8	1.2	tCK	
DQS-In setup time	tWPRES	0	-	0	-	0	-	ns	
DQS-in hold time	tWPREH	0.35	-	0.35	-	0.3	-	tCK	
DQS write postamble	tWPST	0.4	0.6	0.4	0.6	0.4	0.6	tCK	
DQS-In high level width	tDQSH	0.4	0.6	0.4	0.6	0.4	0.6	tCK	
DQS-In low level width	tDQSL	0.4	0.6	0.4	0.6	0.4	0.6	tCK	
Address and Control input setup	tIS	0.9	-	0.9	-	1.0	-	ns	
Address and Control input hold	tIH	0.9	-	0.9	-	1.0	-	ns	
DQ and DM setup time to DQS	tDS	0.40	-	0.4	-	0.45	-	ns	
DQ and DM hold time to DQS	tDH	0.40	-	0.4	-	0.45	-	ns	
Clock half period	tHP	tCLmin or tCHmin	-	tCLmin or tCHmin	-	tCLmin or tCHmin	-	ns	1
Data output hold time from DQS	tQH	tHP-0.4	-	tHP-0.4	-	tHP-0.45	-	ns	1

Note 1 :

- The JEDEC DDR specification currently defines the output data valid window(tDV) as the time period when the data strobe and all data associated with that data strobe are coincidentally valid.
- The previously used definition of tDV(=0.35tCK) artificially penalizes system timing budgets by assuming the worst case output valid window even then the clock duty cycle applied to the device is better than 45/55%
- A new AC timing term, tQH which stands for data output hold time from DQS is defined to account for clock duty cycle variation and replaces tDV
- tQHmin = tHP-X where
 - . tHP=Minimum half clock period for any given cycle and is defined by clock high or clock low time(tCH,tCL)
 - . X=A frequency dependent timing allowance account for tDQSQmax

AC CHARACTERISTICS (I - 1)

Parameter	Symbol	-25		-2A		-33		Unit	Note
		Min	Max	Min	Max	Min	Max		
Row cycle time	tRC	18	-	16	-	16	-	tCK	
Refresh row cycle time	tRFC	19	-	17	-	17	-	tCK	
Row active time	tRAS	13	100K	11	100K	11	100K	tCK	
RAS to CAS delay for Read	tRCDRD	6	-	5	-	5	-	tCK	
RAS to CAS delay for Write	tRCDWR	4	-	3	-	3	-	tCK	
Row precharge time	tRP	5	-	5	-	5	-	tCK	
Row active to Row active	tRRD	4	-	3	-	3	-	tCK	
Last data in to Row precharge @Normal Pre-charge	tWR	4	-	4	-	4	-	tCK	1
Last data in to Row precharge @Auto Pre-charge	tWR_A	4	-	4	-	4	-	tCK	1
Last data in to Read command	tCDLR	3	-	3	-	3	-	tCK	1
Col. address to Col. address	tCCD	1	-	1	-	1	-	tCK	
Mode register set cycle time	tMRD	2	-	2	-	2	-	tCK	
Auto precharge write recovery + Precharge	tDAL	9	-	9	-	9	-	tCK	
Exit self refresh to read command	tXSR	200	-	200	-	200	-	tCK	
Power down exit time	tPDEX	3tCK +tIS	-	3tCK +tIS	-	3tCK +tIS	-	ns	
Refresh interval time	tREF	7.8	-	7.8	-	7.8	-	us	

Note : 1. For normal write operation, even numbers of Din are to be written inside DRAM

AC CHARACTERISTICS (II - 1)

(Unit : Number of Clock)

K4D261638F-TC25

Frequency	Cas Latency	tRC	tRFC	tRAS	tRCDRD	tRCDWR	tRP	tRRD	tDAL	Unit
400MHz (2.5ns)	5	18	19	13	6	4	5	4	9	tCK
350MHz (2.8ns)	4	16	17	11	5	3	5	3	9	tCK
300MHz (3.3ns)	4	16	17	11	5	3	5	3	9	tCK
275MHz (3.6ns)	4	16	17	11	4	2	5	3	9	tCK
250MHz (4.0ns)	3	13	15	9	4	2	4	3	7	tCK
200MHz (5.0ns)	3	12	14	8	4	2	4	3	7	tCK

K4D261638F-TC2A

Frequency	Cas Latency	tRC	tRFC	tRAS	tRCDRD	tRCDWR	tRP	tRRD	tDAL	Unit
350MHz (2.8ns)	4	16	17	11	5	3	5	3	9	tCK
300MHz (3.3ns)	4	16	17	11	5	3	5	3	9	tCK
275MHz (3.6ns)	4	16	17	11	4	2	5	3	9	tCK
250MHz (4.0ns)	3	13	15	9	4	2	4	3	7	tCK
200MHz (5.0ns)	3	12	14	8	4	2	4	3	7	tCK

K4D261638F-TC33

Frequency	Cas Latency	tRC	tRFC	tRAS	tRCDRD	tRCDWR	tRP	tRRD	tDAL	Unit
300MHz (3.3ns)	4	16	17	11	5	3	5	3	9	tCK
275MHz (3.6ns)	4	16	17	11	4	2	5	3	9	tCK
250MHz (4.0ns)	3	13	15	9	4	2	4	3	7	tCK
200MHz (5.0ns)	3	12	14	8	4	2	4	3	7	tCK

AC CHARACTERISTICS (I - 2)

Parameter	Symbol	-36		-40		-50		Unit	Note
		Min	Max	Min	Max	Min	Max		
Row cycle time	tRC	16	-	13	-	12	-	tCK	
Refresh row cycle time	tRFC	17	-	15	-	14	-	tCK	
Row active time	tRAS	11	100K	9	100K	8	100K	tCK	
RAS to CAS delay for Read	tRCDRD	4	-	4	-	4	-	tCK	
RAS to CAS delay for Write	tRCDWR	2	-	2	-	2	-	tCK	
Row precharge time	tRP	5	-	4	-	4	-	tCK	
Row active to Row active	tRRD	3	-	3	-	3	-	tCK	
Last data in to Row precharge @Normal Pre-charge	tWR	4	-	3	-	3	-	tCK	1
Last data in to Row precharge @Auto Pre-charge	tWR_A	4	-	3	-	3	-	tCK	1
Last data in to Read command	tCDLR	2	-	2	-	2	-	tCK	1
Col. address to Col. address	tCCD	1	-	1	-	1	-	tCK	
Mode register set cycle time	tMRD	2	-	2	-	2	-	tCK	
Auto precharge write recovery + Precharge	tDAL	9	-	7	-	7	-	tCK	
Exit self refresh to read command	tXSR	200	-	200	-	200	-	tCK	
Power down exit time	tPDEX	3tCK +tIS	-	3tCK +tIS	-	3tCK +tIS	-	ns	
Refresh interval time	tREF	7.8	-	7.8	-	7.8	-	us	

Note : 1. For normal write operation, even numbers of Din are to be written inside DRAM

AC CHARACTERISTICS (II - 2)

(Unit : Number of Clock)

K4D261638F-TC36

Frequency	Cas Latency	tRC	tRFC	tRAS	tRCDRD	tRCDWR	tRP	tRRD	tDAL	Unit
275MHz (3.6ns)	4	16	17	11	4	2	5	3	9	tCK
250MHz (4.0ns)	3	13	15	9	4	2	4	3	7	tCK
200MHz (5.0ns)	3	12	14	8	4	2	4	3	7	tCK

K4D261638F-TC40

Frequency	Cas Latency	tRC	tRFC	tRAS	tRCDRD	tRCDWR	tRP	tRRD	tDAL	Unit
250MHz (4.0ns)	3	13	15	9	4	2	4	3	7	tCK
200MHz (5.0ns)	3	12	14	8	4	2	4	3	7	tCK

K4D261638F-TC50

Frequency	Cas Latency	tRC	tRFC	tRAS	tRCDRD	tRCDWR	tRP	tRRD	tDAL	Unit
200MHz (5.0ns)	3	12	14	8	4	2	4	3	7	tCK

Simplified Timing @ BL=4

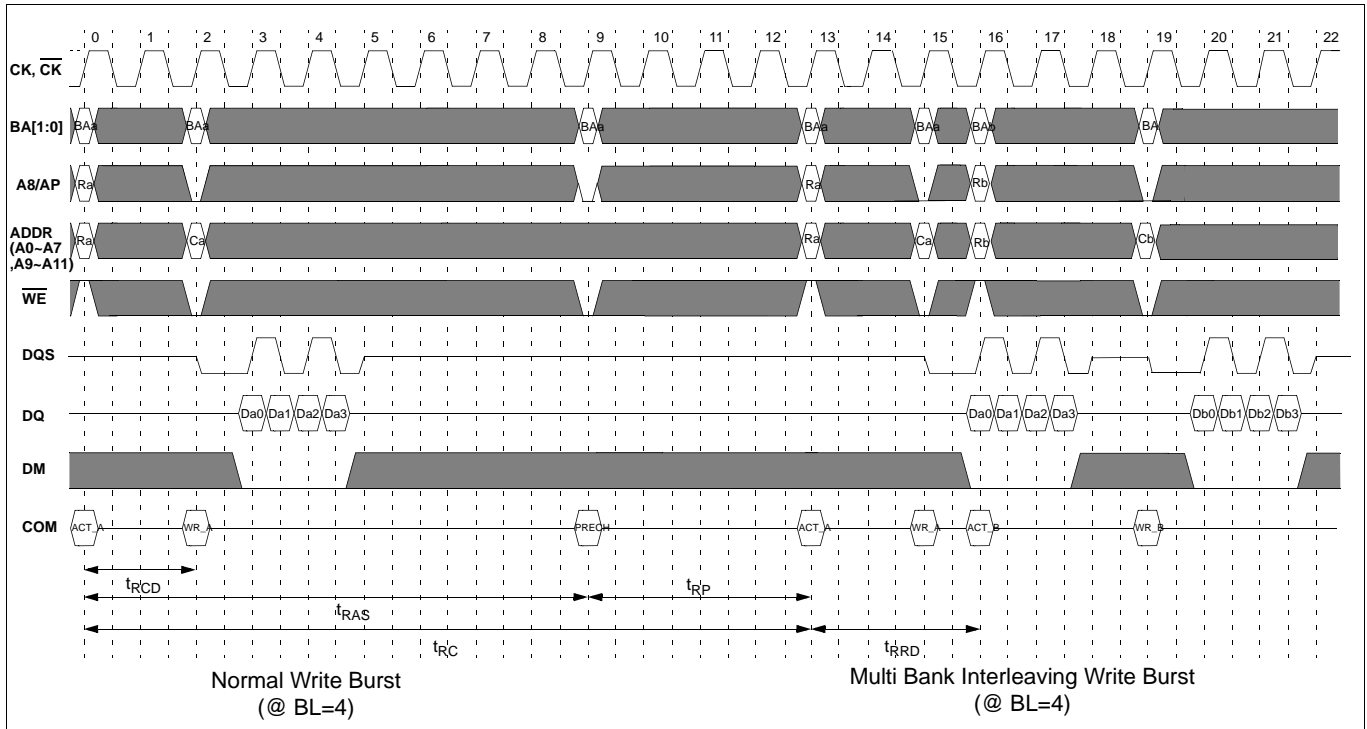

PACKAGE DIMENSIONS (66pin TSOP-II)

