

# 32K x 8 Static RAM

## Features

- **High speed**  
— 12 ns
- **Fast t<sub>DOE</sub>**
- **CMOS for optimum speed/power**
- **Low active power**  
— 495 mW (Max, "L" version)
- **Low standby power**  
— 0.275 mW (Max, "L" version)
- **2V data retention ("L" version only)**
- **Easy memory expansion with  $\overline{CE}$  and  $\overline{OE}$  features**
- **TTL-compatible inputs and outputs**
- **Automatic power-down when deselected**
- **Available in pb-free 28-pin TSOP I and 28-pin (300-Mil) Molded DIP**

## Functional Description

The CY7C199 is a high-performance CMOS static RAM organized as 32,768 words by 8 bits. Easy memory expansion is provided by an active LOW Chip Enable ( $\overline{CE}$ ) and active LOW Output Enable ( $\overline{OE}$ ) and tri-state drivers. This device has an automatic power-down feature, reducing the power consumption by 81% when deselected. The CY7C199 is in the standard 300-mil-wide DIP, SOJ, and LCC packages.

An active LOW Write Enable signal ( $\overline{WE}$ ) controls the writing/reading operation of the memory. When  $\overline{CE}$  and  $\overline{WE}$  inputs are both LOW, data on the eight data input/output pins (I/O<sub>0</sub> through I/O<sub>7</sub>) is written into the memory location addressed by the address present on the address pins (A<sub>0</sub> through A<sub>14</sub>). Reading the device is accomplished by selecting the device and enabling the outputs,  $\overline{CE}$  and  $\overline{OE}$  active LOW, while  $\overline{WE}$  remains inactive or HIGH. Under these conditions, the contents of the location addressed by the information on address pins are present on the eight data input/output pins.

The input/output pins remain in a high-impedance state unless the chip is selected, outputs are enabled, and Write Enable ( $\overline{WE}$ ) is HIGH. A die coat is used to improve alpha immunity.

## Logic Block Diagram

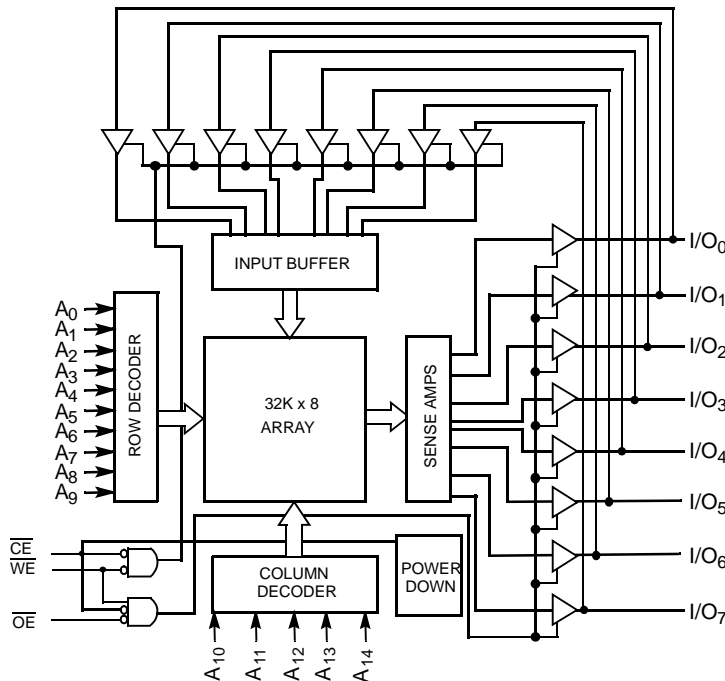

## Pin Configurations

### DIP Top View

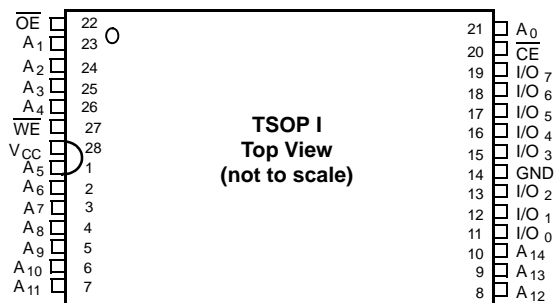
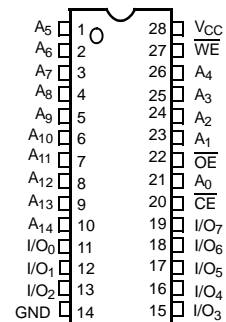

## Selection Guide

	-12	-15	-20	Unit
Maximum Access Time	12	15	20	ns
Maximum Operating Current	160	155	150	mA
L		90		
Maximum CMOS Standby Current	10	10	10	mA
L		0.05		

**Maximum Ratings**

(Above which the useful life may be impaired. For user guidelines, not tested.)

Storage Temperature .....	-65°C to +150°C
Ambient Temperature with Power Applied .....	-55°C to +125°C
Supply Voltage to Ground Potential (Pin 28 to Pin 14) .....	-0.5V to +7.0V
DC Voltage Applied to Outputs in High-Z State <sup>[1]</sup> .....	-0.5V to $V_{CC} + 0.5V$

DC Input Voltage <sup>[1]</sup> .....	-0.5V to $V_{CC} + 0.5V$
Output Current into Outputs (LOW) .....	20 mA
Static Discharge Voltage .....	> 2001V (per MIL-STD-883, Method 3015)
Latch-up Current .....	> 200 mA

**Operating Range**

Range	Ambient Temperature <sup>[2]</sup>	$V_{CC}$
Commercial	0°C to +70°C	5V ± 10%

**Electrical Characteristics** Over the Operating Range <sup>[3]</sup>

Parameter	Description	Test Conditions	-12		-15		-20		Unit	
			Min.	Max.	Min.	Max.	Min.	Max.		
$V_{OH}$	Output HIGH Voltage	$V_{CC} = \text{Min.}, I_{OH} = -4.0 \text{ mA}$	2.4		2.4		2.4		V	
$V_{OL}$	Output LOW Voltage	$V_{CC} = \text{Min.}, I_{OL} = 8.0 \text{ mA}$		0.4		0.4		0.4	V	
$V_{IH}$	Input HIGH Voltage		2.2	$V_{CC} + 0.3V$	2.2	$V_{CC} + 0.3V$	2.2	$V_{CC} + 0.3V$	V	
$V_{IL}$	Input LOW Voltage		-0.5	0.8	-0.5	0.8	-0.5	0.8	V	
$I_{IX}$	Input Leakage Current	$GND \leq V_I \leq V_{CC}$	-5	+5	-5	+5	-5	+5	µA	
$I_{OZ}$	Output Leakage Current	$GND \leq V_O \leq V_{CC}$ , Output Disabled	-5	+5	-5	+5	-5	+5	µA	
$I_{CC}$	$V_{CC}$ Operating Supply Current	$V_{CC} = \text{Max.}, I_{OUT} = 0 \text{ mA}, f = f_{MAX} = 1/t_{RC}$	Com'l		160		155		150	mA
			L				90			mA
$I_{SB1}$	Automatic CE Power-down Current—TTL Inputs	Max. $V_{CC}$ , $\overline{CE} \geq V_{IH}$ , $V_{IN} \geq V_{IH}$ or $V_{IN} \leq V_{IL}$ , $f = f_{MAX}$	Com'l		30		30		30	mA
			L				5			mA
$I_{SB2}$	Automatic CE Power-down Current—CMOS Inputs	Max. $V_{CC}$ , $\overline{CE} \geq V_{CC} - 0.3V$ , $V_{IN} \geq V_{CC} - 0.3V$ or $V_{IN} \leq 0.3V$ , $f = 0$	Com'l		10		10		10	mA
			L				0.05			mA

**Notes:**

- $V_{IL}(\text{min.}) = -2.0V$  for pulse durations of less than 20 ns.
- $T_A$  is the "instant on" case temperature.
- See the last page of this specification for Group A subgroup testing information.

Capacitance<sup>[4]</sup>

Parameter	Description	Test Conditions	Max.	Unit
C <sub>IN</sub>	Input Capacitance	T <sub>A</sub> = 25°C, f = 1 MHz, V <sub>CC</sub> = 5.0V	8	pF
C <sub>OUT</sub>	Output Capacitance		8	pF

AC Test Loads and Waveforms<sup>[5]</sup>

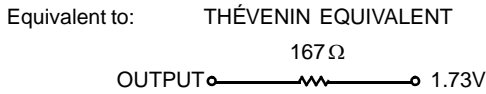
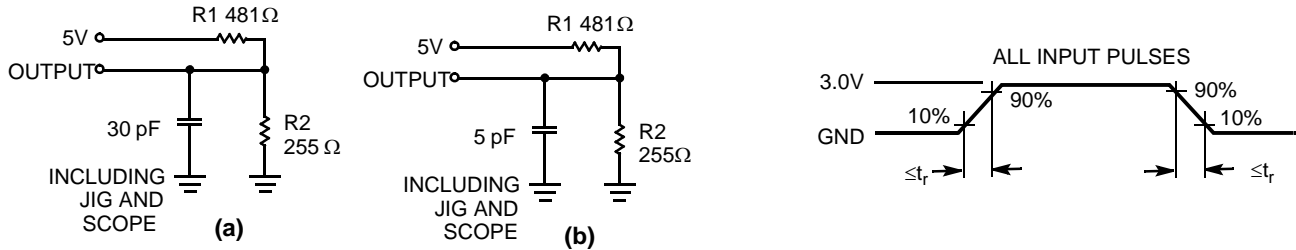

Data Retention Characteristics Over the Operating Range (L-version only)

Parameter	Description	Conditions <sup>[6]</sup>	Min.	Max.	Unit
V <sub>DR</sub>	V <sub>CC</sub> for Data Retention		2.0		V
I <sub>CCDR</sub>	Data Retention Current	V <sub>CC</sub> = V <sub>DR</sub> = 2.0V, CE ≥ V <sub>CC</sub> - 0.3V, V <sub>IN</sub> ≥ V <sub>CC</sub> - 0.3V or V <sub>IN</sub> ≤ 0.3V		10	μA
t <sub>CDR</sub> <sup>[4]</sup>	Chip Deselect to Data Retention Time		0		ns
t <sub>R</sub> <sup>[5]</sup>	Operation Recovery Time		200		μs

Data Retention Waveform

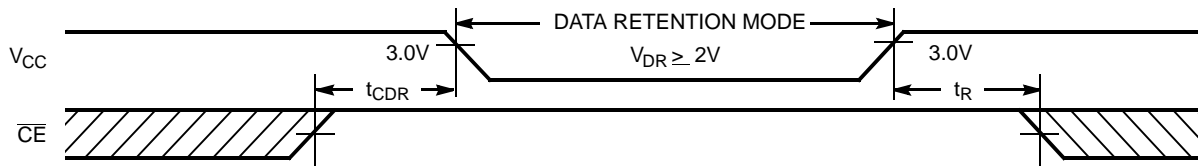

Notes:

- 4. Tested initially and after any design or process changes that may affect these parameters.
- 5. t<sub>R</sub> ≤ 3 ns for the -12 and the -15 speeds. t<sub>R</sub> ≤ 5 ns for the -20 and slower speeds.
- 6. No input may exceed V<sub>CC</sub> + 0.5V.

**Switching Characteristics** Over the Operating Range <sup>[3,7]</sup>

Parameter	Description	-12		-15		-20		Unit
		Min.	Max.	Min.	Max.	Min.	Max.	
<b>Read Cycle</b>								
$t_{RC}$	Read Cycle Time	12		15		20		ns
$t_{AA}$	Address to Data Valid		12		15		20	ns
$t_{OHA}$	Data Hold from Address Change	3		3		3		ns
$t_{ACE}$	$\overline{CE}$ LOW to Data Valid		12		15		20	ns
$t_{DOE}$	$\overline{OE}$ LOW to Data Valid		5		7		9	ns
$t_{LZOE}$	$\overline{OE}$ LOW to Low-Z <sup>[8]</sup>	0		0		0		ns
$t_{HZOE}$	$\overline{OE}$ HIGH to High-Z <sup>[8, 9]</sup>		5		7		9	ns
$t_{LZCE}$	$\overline{CE}$ LOW to Low-Z <sup>[8]</sup>	3		3		3		ns
$t_{HZCE}$	$\overline{CE}$ HIGH to High-Z <sup>[8, 9]</sup>		5		7		9	ns
$t_{PU}$	$\overline{CE}$ LOW to Power-up	0		0		0		ns
$t_{PD}$	$\overline{CE}$ HIGH to Power-down		12		15		20	ns
<b>Write Cycle<sup>[10, 11]</sup></b>								
$t_{WC}$	Write Cycle Time	12		15		20		ns
$t_{SCE}$	$\overline{CE}$ LOW to Write End	9		10		15		ns
$t_{AW}$	Address Set-up to Write End	9		10		15		ns
$t_{HA}$	Address Hold from Write End	0		0		0		ns
$t_{SA}$	Address Set-up to Write Start	0		0		0		ns
$t_{PWE}$	$\overline{WE}$ Pulse Width	8		9		15		ns
$t_{SD}$	Data Set-up to Write End	8		9		10		ns
$t_{HD}$	Data Hold from Write End	0		0		0		ns
$t_{HZWE}$	$\overline{WE}$ LOW to High-Z <sup>[9]</sup>		7		7		10	ns
$t_{LZWE}$	$\overline{WE}$ HIGH to Low-Z <sup>[8]</sup>	3		3		3		ns

**Notes:**

7. Test conditions assume signal transition time of 3 ns or less for -12 and -15 speeds and 5 ns or less for -20 and slower speeds, timing reference levels of 1.5V, input pulse levels of 0 to 3.0V, and output loading of the specified  $I_{OL}/I_{OH}$  and 30-pF load capacitance.
8. At any given temperature and voltage condition,  $t_{HZCE}$  is less than  $t_{LZCE}$ ,  $t_{HZOE}$  is less than  $t_{LZOE}$ , and  $t_{HZWE}$  is less than  $t_{LZWE}$  for any given device.
9.  $t_{HZOE}$ ,  $t_{HZCE}$ , and  $t_{HZWE}$  are specified with  $C_L = 5$  pF as in part (b) of AC Test Loads. Transition is measured  $\pm 500$  mV from steady-state voltage.
10. The internal write time of the memory is defined by the overlap of  $\overline{CE}$  LOW and  $\overline{WE}$  LOW. Both signals must be LOW to initiate a write and either signal can terminate a write by going HIGH. The data input set-up and hold timing should be referenced to the rising edge of the signal that terminates the write.
11. The minimum write cycle time for write cycle #3 ( $\overline{WE}$  controlled,  $\overline{OE}$  LOW) is the sum of  $t_{HZWE}$  and  $t_{SD}$ .

### Switching Waveforms

#### Read Cycle No. 1 [12, 13]

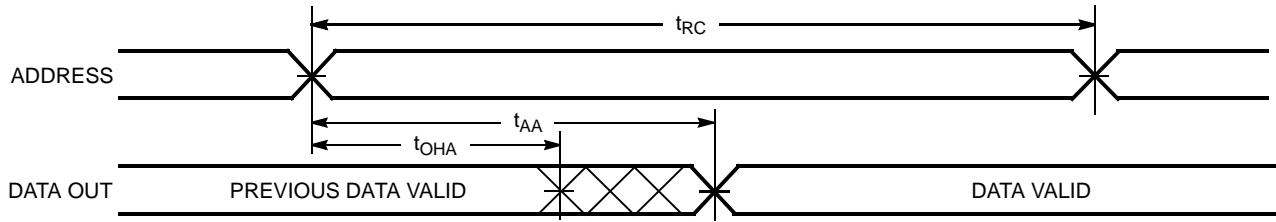

#### Read Cycle No. 2 [13, 14]

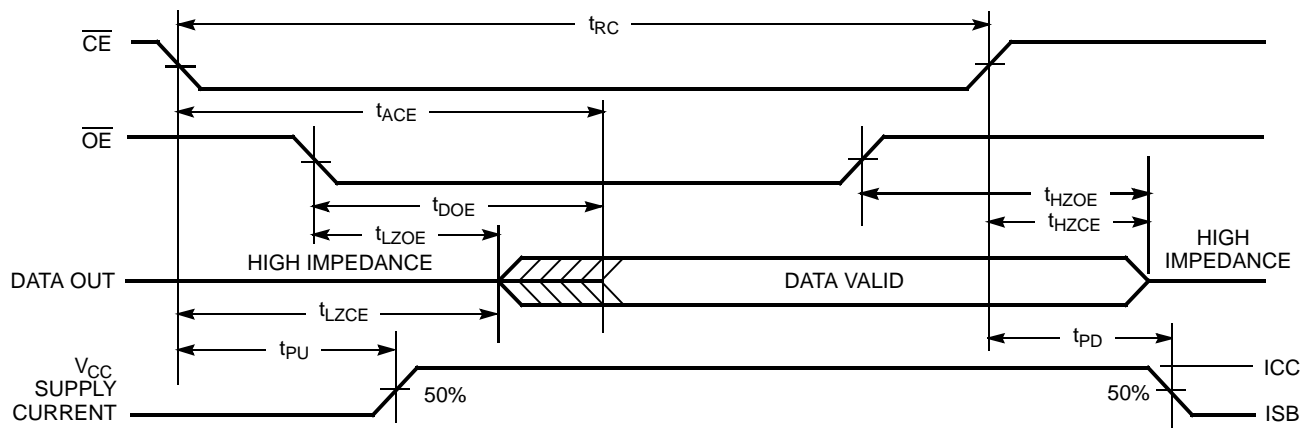

**Notes:**

- 12. Device is continuously selected.  $\overline{OE}, \overline{CE} = V_{IL}$ .
- 13.  $\overline{WE}$  is HIGH for read cycle.
- 14. Address valid prior to or coincident with  $\overline{CE}$  transition LOW.

Switching Waveforms (continued)

Write Cycle No. 1 ( $\overline{WE}$  Controlled)<sup>[10, 15, 16]</sup>

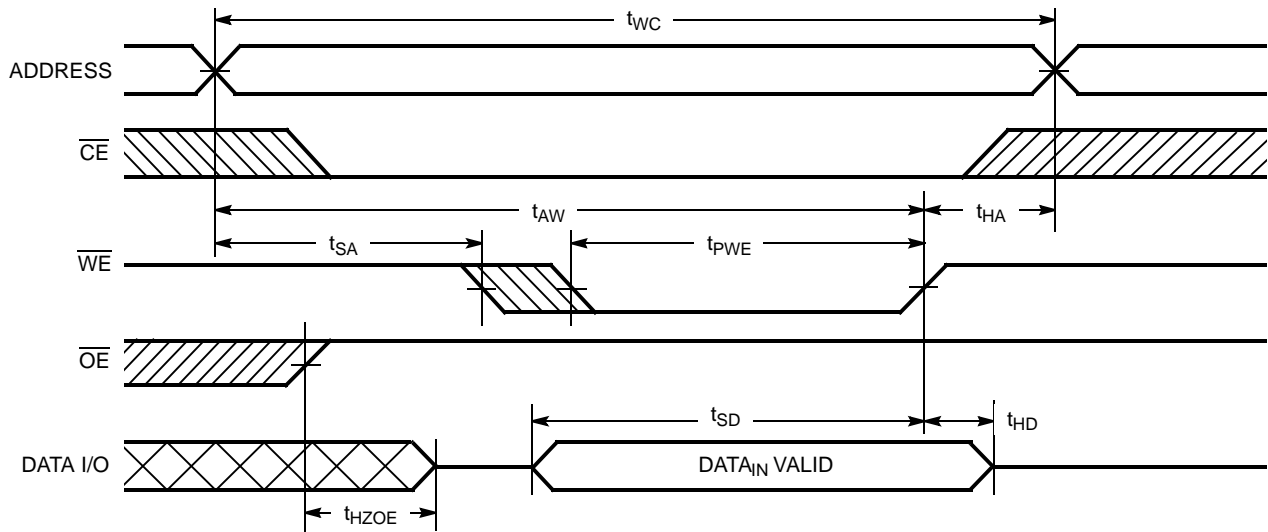

Write Cycle No. 2 ( $\overline{CE}$  Controlled)<sup>[10, 15, 16]</sup>

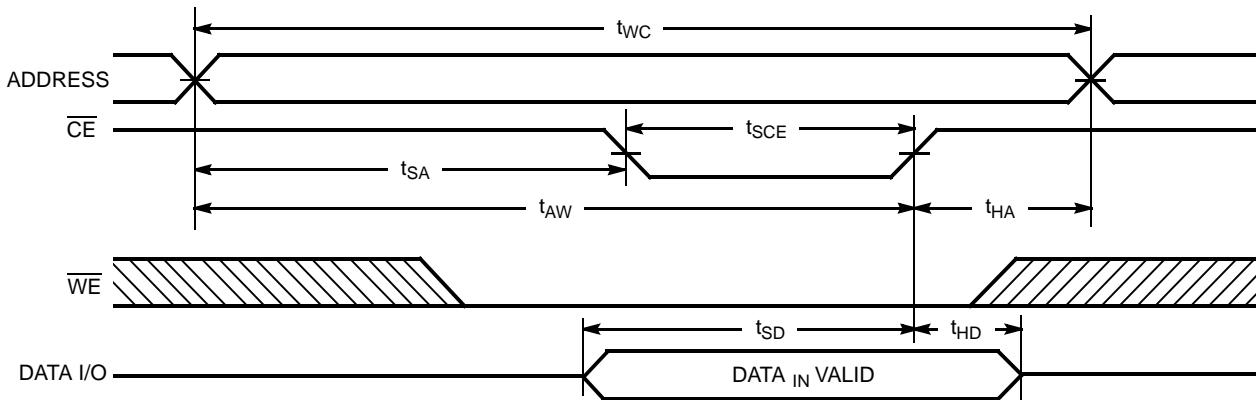

Notes:

- 15. Data I/O is high impedance if  $\overline{OE} = V_{IH}$ .
- 16. If  $\overline{CE}$  goes HIGH simultaneously with  $\overline{WE}$  HIGH, the output remains in a high-impedance state.

Switching Waveforms (continued)

Write Cycle No. 3 ( $\overline{WE}$  Controlled  $\overline{OE}$  LOW)<sup>[11, 16]</sup>

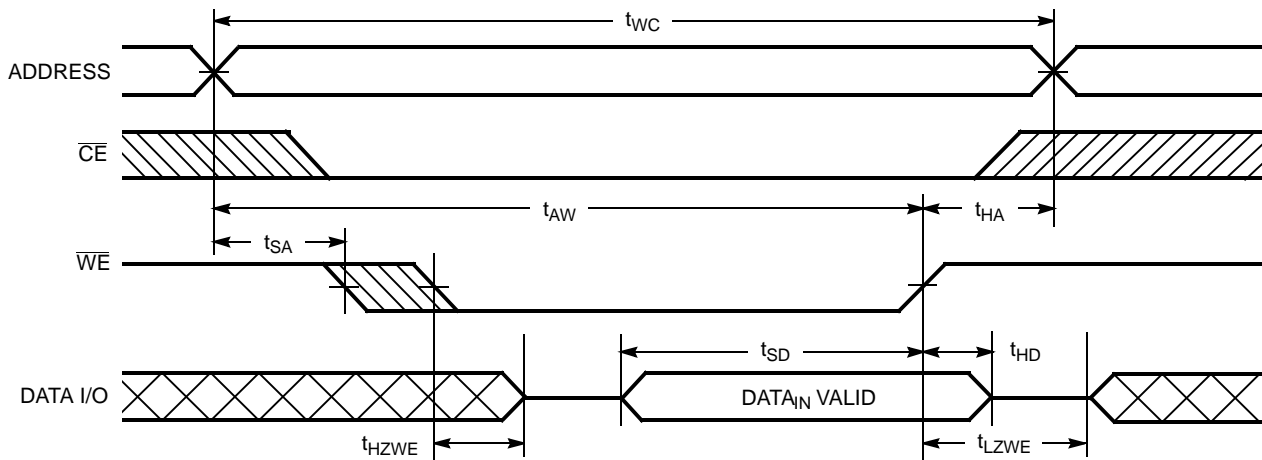

Typical DC and AC Characteristics

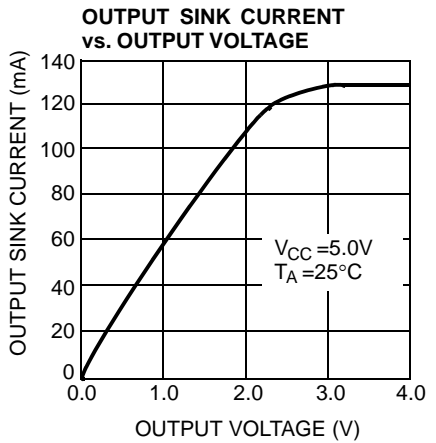
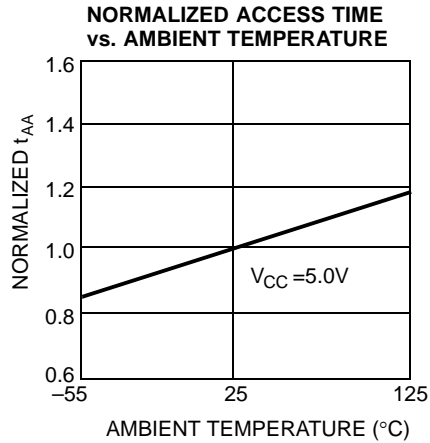
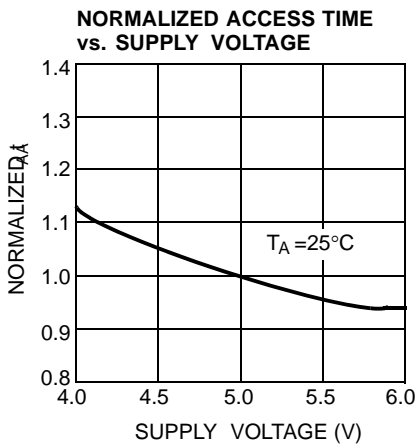
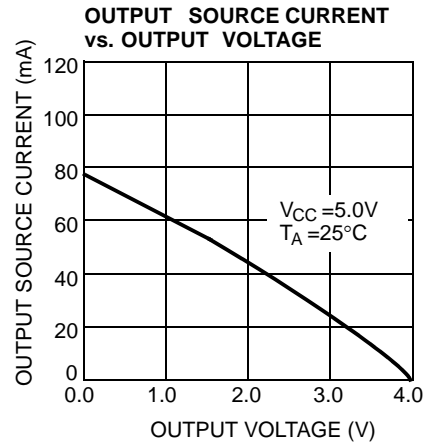
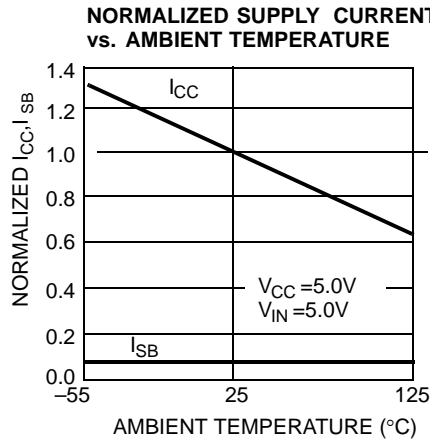
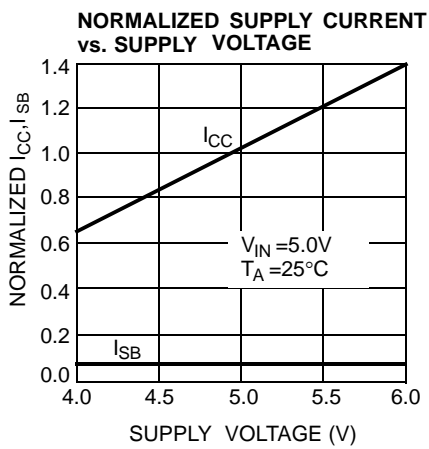

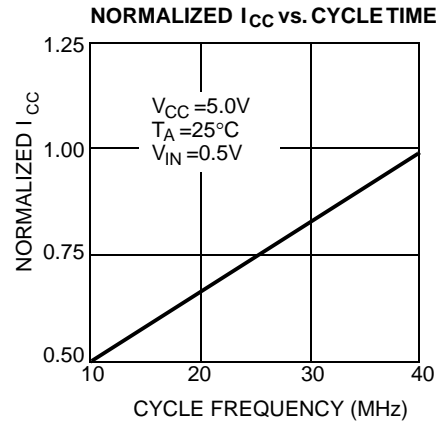
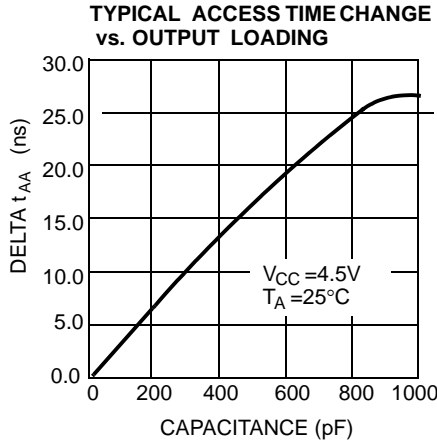
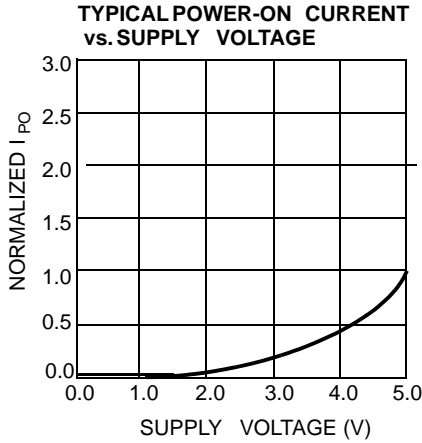
**Typical DC and AC Characteristics (continued)**

**Truth Table**

$\overline{CE}$	$\overline{WE}$	$\overline{OE}$	Inputs/Outputs	Mode	Power
H	X	X	High Z	Deselect/Power-down	Standby ( $I_{SB}$ )
L	H	L	Data Out	Read	Active ( $I_{CC}$ )
L	L	X	Data In	Write	Active ( $I_{CC}$ )
L	H	H	High Z	Deselect, Output disabled	Active ( $I_{CC}$ )

**Ordering Information**

Speed (ns)	Ordering Code	Package Diagram	Package Type	Operating Range
12	CY7C199-12ZXC	51-85071	28-pin TSOP I (Pb-free)	Commercial
15	CY7C199-15ZXC	51-85071	28-pin TSOP I (Pb-free)	Commercial
	CY7C199L-15ZXC			
20	CY7C199-20PXC	51-85014	28-pin (300-Mil) Molded DIP (Pb-free)	Commercial



Package Diagrams

28-pin (300-Mil) PDIP (51-85014)

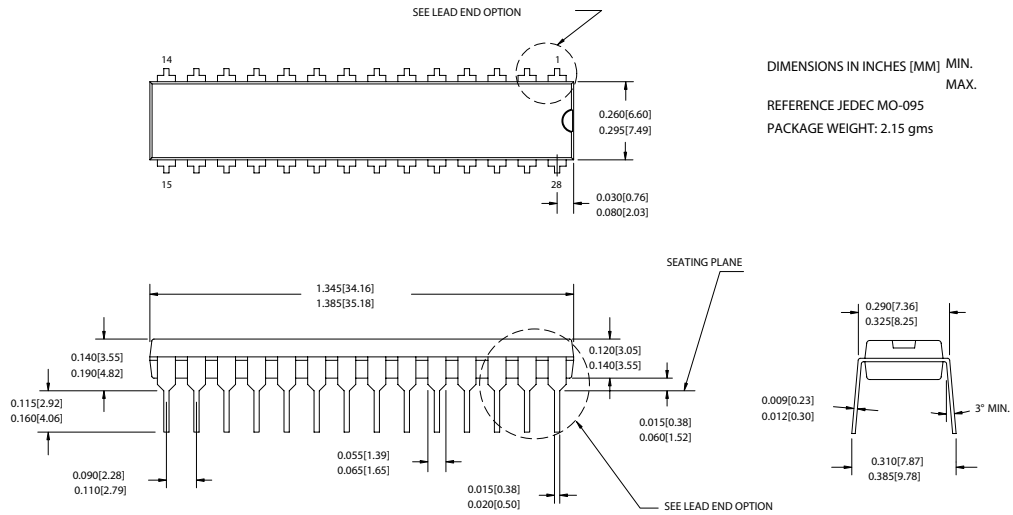

LEAD END OPTION  
(LEAD #1, 14, 15 & 28)

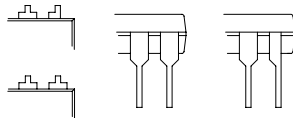

51-85014-\*D

Package Diagrams (continued)

28-pin TSOP Type 1 (8x13.4 mm) (51-85071)

NOTE: ORIENTATION I.D. MAY BE LOCATED EITHER AS SHOWN IN OPTION 1 OR OPTION 2

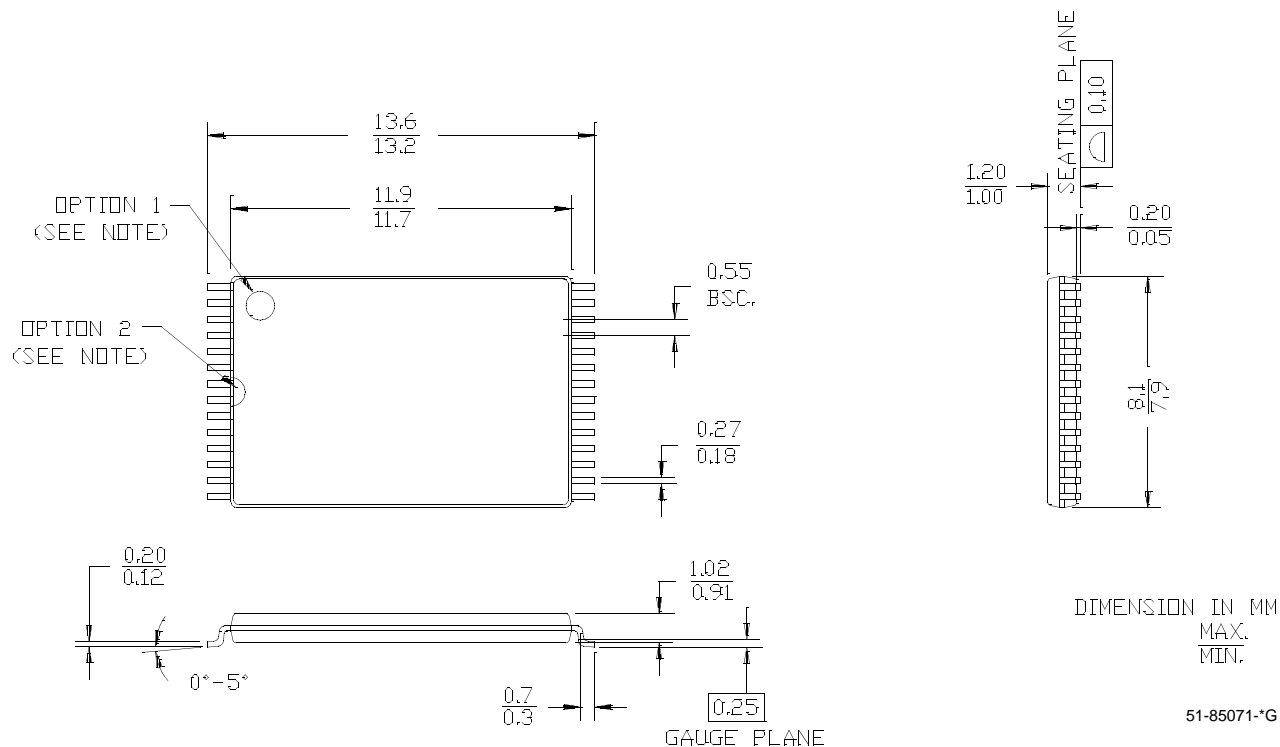

All products and company names mentioned in this document are the trademarks of their respective holders.

**Document History Page**

Document Title: CY7C199 32K x 8 Static RAM Document Number: 38-05160				
REV.	ECN NO.	Issue Date	Orig. of Change	Description of Change
**	109971	10/28/01	SZV	Change from Spec number: 38-00239 to 38-05160
*A	121730	01/09/02	DFP	Updated Product Offering table
*B	492500	See ECN	NXR	Removed 8 ns, 10 ns, 25 ns , 35 ns, 45 ns speed bins Removed 28-Lead (300-Mil) CerDIP, 28-Pin Rectangular Leadless Chip Carrier, 28-Lead Molded SOIC, 28-Lead Molded SOJ packages from product offering Changed the description of $I_{IX}$ from Input Load Current to Input Leakage Current in DC Electrical Characteristics table Removed $I_{OS}$ parameter from DC Electrical Characteristics Table Updated Ordering Information Table