

32K x 16 Static RAM

Features

- **5.0V operation ($\pm 10\%$)**
- **High speed**
— $t_{AA} = 10 \text{ ns}$
- **Low active power**
— **825 mW (max., 10 ns, "L" version)**
- **Very Low standby power**
— **550 μW (max., "L" version)**
- **Automatic power-down when deselected**
- **Independent Control of Upper and Lower bytes**
- **Available in 44-pin TSOP II and 400-mil SOJ**

Functional Description

The CY7C1020 is a high-performance CMOS static RAM organized as 32,768 words by 16 bits. This device has an automatic power-down feature that significantly reduces power consumption when deselected.

Writing to the device is accomplished by taking Chip Enable ($\overline{\text{CE}}$) and Write Enable ($\overline{\text{WE}}$) inputs LOW. If Byte Low Enable

($\overline{\text{BLE}}$) is LOW, then data from I/O pins (I/O_1 through I/O_8), is written into the location specified on the address pins (A_0 through A_{14}). If Byte High Enable ($\overline{\text{BHE}}$) is LOW, then data from I/O pins (I/O_9 through I/O_{16}) is written into the location specified on the address pins (A_0 through A_{14}).

Reading from the device is accomplished by taking Chip Enable ($\overline{\text{CE}}$) and Output Enable ($\overline{\text{OE}}$) LOW while forcing the Write Enable ($\overline{\text{WE}}$) HIGH. If Byte Low Enable ($\overline{\text{BLE}}$) is LOW, then data from the memory location specified by the address pins will appear on I/O_1 to I/O_8 . If Byte High Enable ($\overline{\text{BHE}}$) is LOW, then data from memory will appear on I/O_9 to I/O_{16} . See the truth table at the back of this data sheet for a complete description of read and write modes.

The input/output pins (I/O_1 through I/O_{16}) are placed in a high-impedance state when the device is deselected ($\overline{\text{CE}}$ HIGH), the outputs are disabled ($\overline{\text{OE}}$ HIGH), the $\overline{\text{BHE}}$ and $\overline{\text{BLE}}$ are disabled ($\overline{\text{BHE}}$, $\overline{\text{BLE}}$ HIGH), or during a write operation ($\overline{\text{CE}}$ LOW, and $\overline{\text{WE}}$ LOW).

The CY7C1020 is available in standard 44-pin TSOP type II and 400-mil-wide SOJ packages.

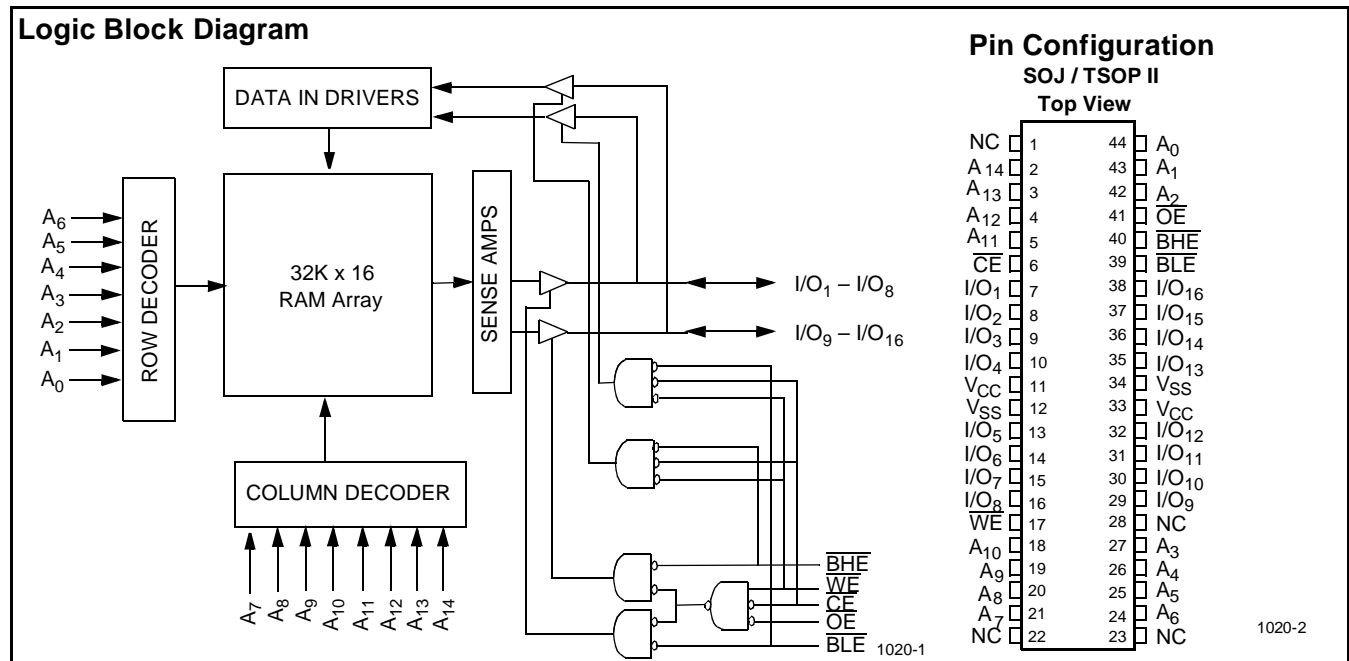

Selection Guide

	7C1020-10	7C1020-12	7C1020-15	7C1020-20
Maximum Access Time (ns)	10	12	15	20
Maximum Operating Current (mA)		180	170	160
	L	150	140	130
Maximum CMOS Standby Current (mA)		3	3	3
	L	0.1	0.1	0.1

Maximum Ratings

(Above which the useful life may be impaired. For user guidelines, not tested.)

Storage Temperature -65°C to +150°C
 Ambient Temperature with
 Power Applied -55°C to +125°C
 Supply Voltage on V_{CC} to Relative GND^[1] -0.5V to +7.0V
 DC Voltage Applied to Outputs
 in High Z State^[1] -0.5V to V_{CC} +0.5V
 DC Input Voltage^[1] -0.5V to V_{CC} +0.5V

Current into Outputs (LOW) 20 mA
 Static Discharge Voltage >2001V
 (per MIL-STD-883, Method 3015)
 Latch-Up Current >200 mA

Operating Range

Range	Ambient Temperature ^[2]	V _{CC}
Commercial	0°C to +70°C	4.5V–5.5V

Electrical Characteristics Over the Operating Range

Parameter	Description	Test Conditions	7C1020-10		7C1020-12		7C1020-15		Unit
			Min.	Max.	Min.	Max.	Min.	Max.	
V _{OH}	Output HIGH Voltage	V _{CC} = Min., I _{OH} = -4.0 mA	2.4		2.4		2.4		V
V _{OL}	Output LOW Voltage	V _{CC} = Min., I _{OL} = 8.0 mA		0.4		0.4		0.4	V
V _{IH}	Input HIGH Voltage		2.2	6.0	2.2	6.0	2.2	6.0	V
V _{IL}	Input LOW Voltage ^[1]		-0.5	0.8	-0.5	0.8	-0.5	0.8	V
I _{IX}	Input Load Current	GND ≤ V _I ≤ V _{CC}	-1	+1	-1	+1	-1	+1	μA
I _{OZ}	Output Leakage Current	GND ≤ V _I ≤ V _{CC} , Output Disabled	-2	+2	-2	+2	-2	+2	μA
I _{CC}	V _{CC} Operating Supply Current	V _{CC} = Max., I _{OUT} = 0 mA, f = f _{MAX} = 1/t _{RC}		180		170		160	mA
			L	150		140		130	
I _{SB1}	Automatic CE Power-Down Current —TTL Inputs	Max. V _{CC} , $\overline{CE} \geq V_{IH}$ V _{IN} ≥ V _{IH} or V _{IN} ≤ V _{IL} , f = f _{MAX}		20		20		20	mA
			L	10		10		10	
I _{SB2}	Automatic CE Power-Down Current —CMOS Inputs	Max. V _{CC} , $\overline{CE} \geq V_{CC} - 0.3V$, V _{IN} ≥ V _{CC} - 0.3V, or V _{IN} ≤ 0.3V, f = 0		3		3		3	mA
			L	100		100		100	μA

Notes:

- V_{IL} (min.) = -2.0V for pulse durations of less than 20 ns.
- T_A is the case temperature.

Electrical Characteristics Over the Operating Range (continued)

Parameter	Description	Test Conditions	7C1020-20		Unit
			Min.	Max.	
V_{OH}	Output HIGH Voltage	$V_{CC} = \text{Min.}, I_{OH} = -4.0 \text{ mA}$	2.4		V
V_{OL}	Output LOW Voltage	$V_{CC} = \text{Min.}, I_{OL} = 8.0 \text{ mA}$		0.4	V
V_{IH}	Input HIGH Voltage		2.2	6.0	V
V_{IL}	Input LOW Voltage ^[1]		-0.5	0.8	V
I_{IX}	Input Load Current	$GND \leq V_I \leq V_{CC}$	-1	+1	μA
I_{OZ}	Output Leakage Current	$GND \leq V_I \leq V_{CC}$, Output Disabled	-2	+2	μA
I_{CC}	V_{CC} Operating Supply Current	$V_{CC} = \text{Max.}, I_{OUT} = 0 \text{ mA}, f = f_{MAX} = 1/t_{RC}$		160	mA
			L	130	
I_{SB1}	Automatic CE Power-Down Current —TTL Inputs	Max. V_{CC} , $\overline{CE} \geq V_{IH}$ $V_{IN} \geq V_{IH}$ or $V_{IN} \leq V_{IL}, f = f_{MAX}$		20	mA
			L	10	
I_{SB2}	Automatic CE Power-Down Current —CMOS Inputs	Max. V_{CC} , $\overline{CE} \geq V_{CC} - 0.3\text{V}$, $V_{IN} \geq V_{CC} - 0.3\text{V}$, or $V_{IN} \leq 0.3\text{V}, f = 0$		3	mA
			L	100	μA

Capacitance^[3]

Parameter	Description	Test Conditions	Max.	Unit
C_{IN}	Input Capacitance	$T_A = 25^\circ\text{C}, f = 1 \text{ MHz}, V_{CC} = 5.0\text{V}$	8	pF
C_{OUT}	Output Capacitance		8	pF

Note:

3. Tested initially and after any design or process changes that may affect these parameters.

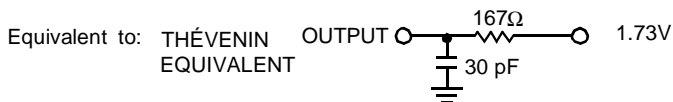
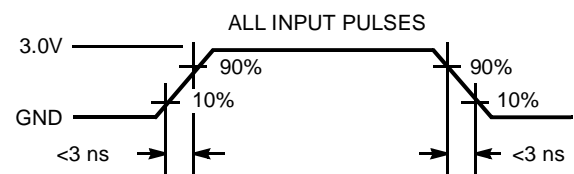
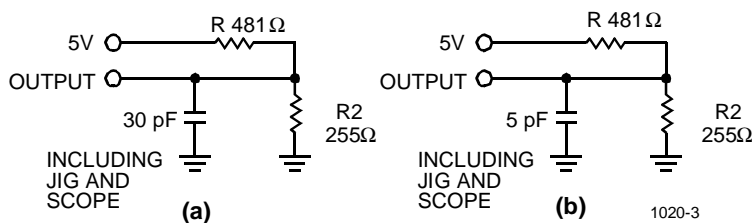
AC Test Loads and Waveforms

1020-4

Switching Characteristics^[4] Over the Operating Range

Parameter	Description	7C1020-10		7C1020-12		7C1020-15		7C1020-20		Unit
		Min.	Max.	Min.	Max.	Min.	Max.	Min.	Max.	
READ CYCLE										
t_{RC}	Read Cycle Time	10		12		15		20		ns
t_{AA}	Address to Data Valid		10		12		15		20	ns
t_{OHA}	Data Hold from Address Change	3		3		3		3		ns
t_{ACE}	\overline{CE} LOW to Data Valid		10		12		15		20	ns
t_{DOE}	\overline{OE} LOW to Data Valid		5		5		7		9	ns
t_{LZOE}	\overline{OE} LOW to Low Z	0		0		0		0		ns
t_{HZOE}	\overline{OE} HIGH to High Z ^[5, 6]		5		6		7		8	ns
t_{LZCE}	\overline{CE} LOW to Low Z ^[6]	3		3		3		3		ns
t_{HZCE}	\overline{CE} HIGH to High Z ^[5, 6]		5		6		7		8	ns
t_{PU}	\overline{CE} LOW to Power-Up	0		0		0		0		ns
t_{PD}	\overline{CE} HIGH to Power-Down		12		12		15		20	ns
t_{DBE}	Byte enable to Data Valid		5		6		7		9	ns
t_{LZBE}	Byte enable to Low Z	0		0		0		0		ns
t_{HZBE}	Byte disable to High Z		5		6		7		9	ns
WRITE CYCLE^[7]										
t_{WC}	Write Cycle Time	10		12		15		12		ns
t_{SCE}	\overline{CE} LOW to Write End	8		9		10		12		ns
t_{AW}	Address Set-Up to Write End	7		8		10		12		ns
t_{HA}	Address Hold from Write End	0		0		0		0		ns
t_{SA}	Address Set-Up to Write Start	0		0		0		0		ns
t_{PWE}	\overline{WE} Pulse Width	7		8		10		12		ns
t_{SD}	Data Set-Up to Write End	5		6		10		10		ns
t_{HD}	Data Hold from Write End	0		0		0		0		ns
t_{LZWE}	\overline{WE} HIGH to Low Z ^[6]	3		3		3		3		ns
t_{HZWE}	\overline{WE} LOW to High Z ^[5, 6]		5		6		7		9	ns
t_{BW}	Byte enable to end of write	7		8		9		12		ns

Notes:

- Test conditions assume signal transition time of 3 ns or less, timing reference levels of 1.5V, input pulse levels of 0 to 3.0V, and output loading of the specified I_{OL}/I_{OH} and 30-pF load capacitance.
- t_{HZOE} , t_{HZBE} , t_{HZCE} , and t_{HZWE} are specified with a load capacitance of 5 pF as in part (b) of AC Test Loads. Transition is measured ± 500 mV from steady-state voltage.
- At any given temperature and voltage condition, t_{HZCE} is less than t_{LZCE} , t_{HZOE} is less than t_{LZOE} , and t_{HZWE} is less than t_{LZWE} for any given device.
- The internal write time of the memory is defined by the overlap of \overline{CE} LOW, \overline{WE} LOW and BHE / BLE LOW. \overline{CE} , \overline{WE} and BHE / BLE must be LOW to initiate a write, and the transition of these signals can terminate the write. The input data set-up and hold timing should be referenced to the leading edge of the signal that terminates the write.

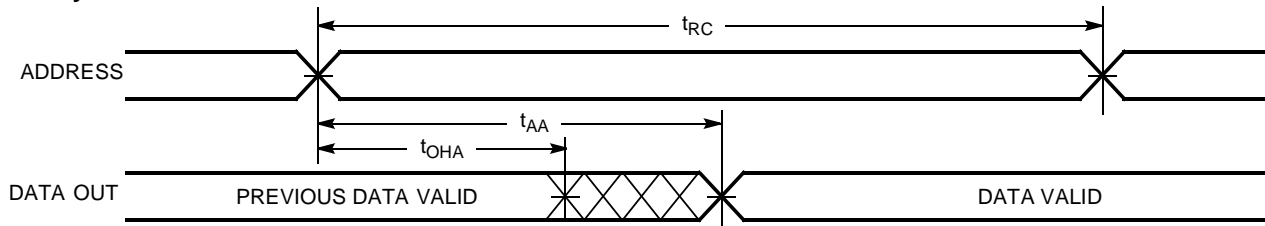
Switching Waveforms
Read Cycle No. 1 ^[8, 9]

1020-5

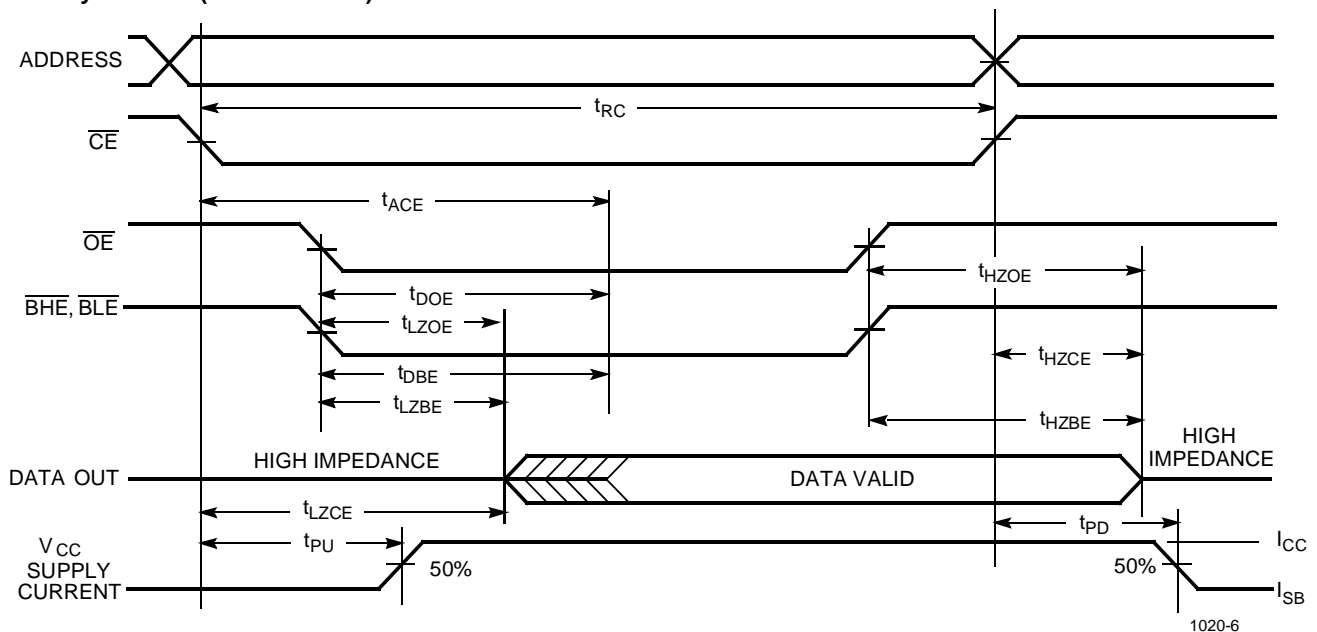
Read Cycle No. 2 (\overline{OE} Controlled) ^[9, 10]

1020-6

Notes:

8. Device is continuously selected. \overline{OE} , \overline{CE} , \overline{BHE} and/or $\overline{BLE} = V_{IL}$.
9. \overline{WE} is HIGH for read cycle.
10. Address valid prior to or coincident with \overline{CE} transition LOW.

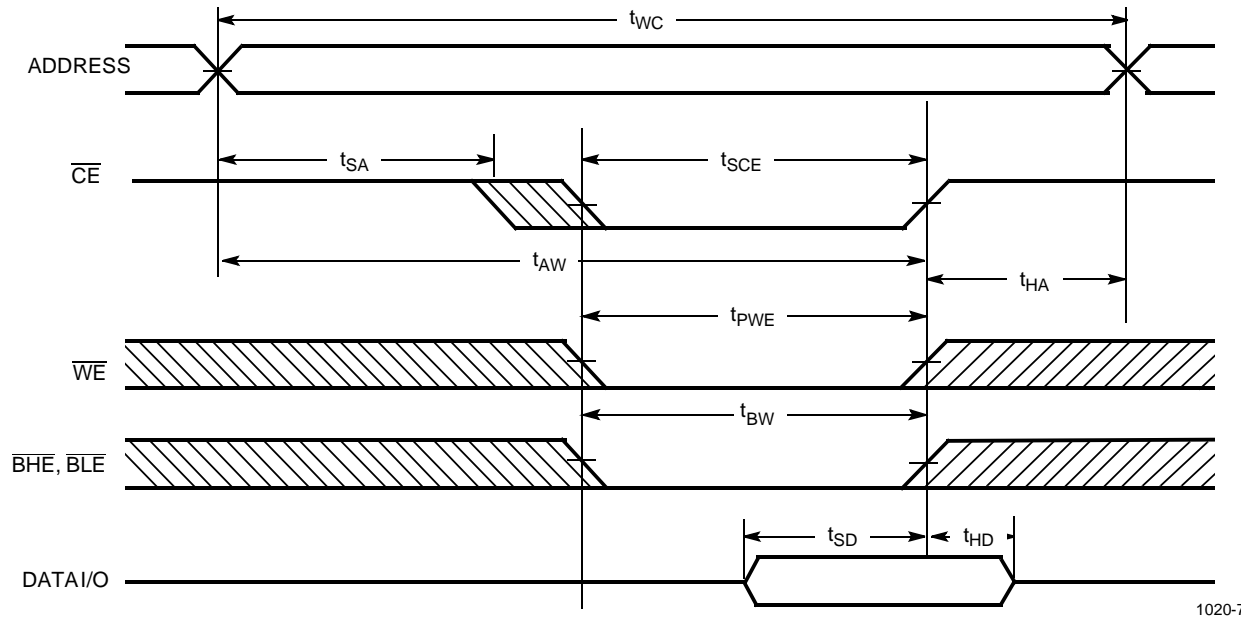
Switching Waveforms (continued)
Write Cycle No. 1 ($\overline{\text{CE}}$ Controlled)^[11, 12]

1020-7

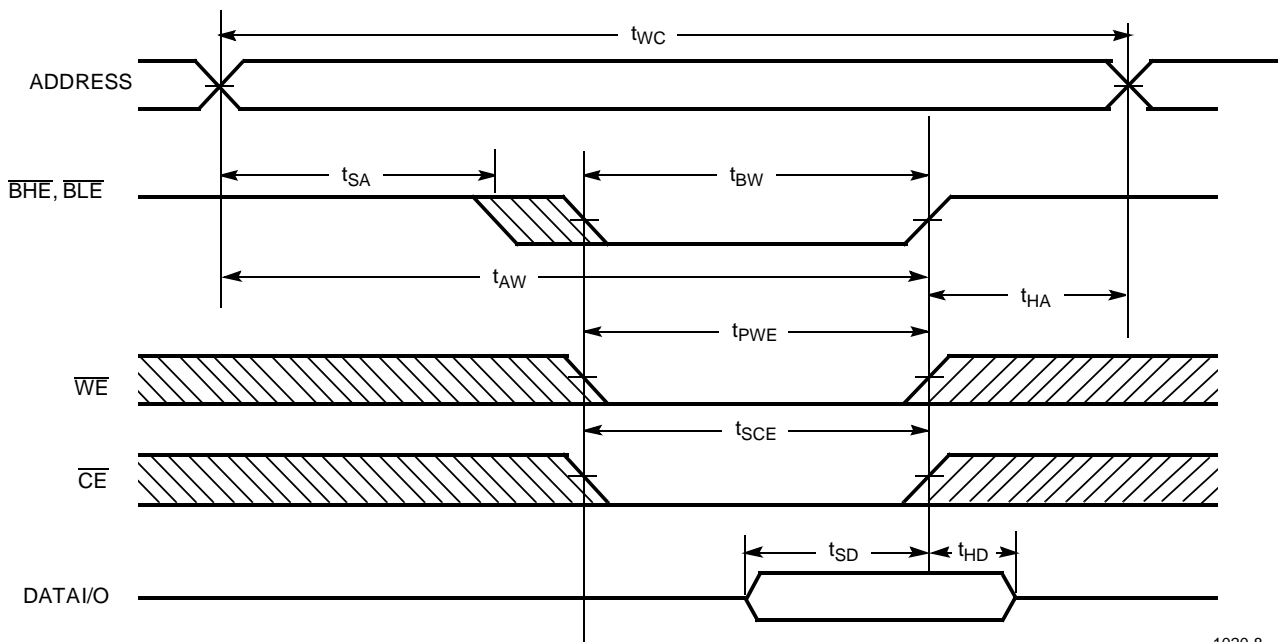
Write Cycle No. 2 ($\overline{\text{BLE}}$ or $\overline{\text{BHE}}$ Controlled)

1020-8

Notes:

11. Data I/O is high impedance if $\overline{\text{OE}}$ or $\overline{\text{BHE}}$ and/or $\overline{\text{BLE}} = V_{IH}$.
12. If $\overline{\text{CE}}$ goes HIGH simultaneously with $\overline{\text{WE}}$ going HIGH, the output remains in a high-impedance state.

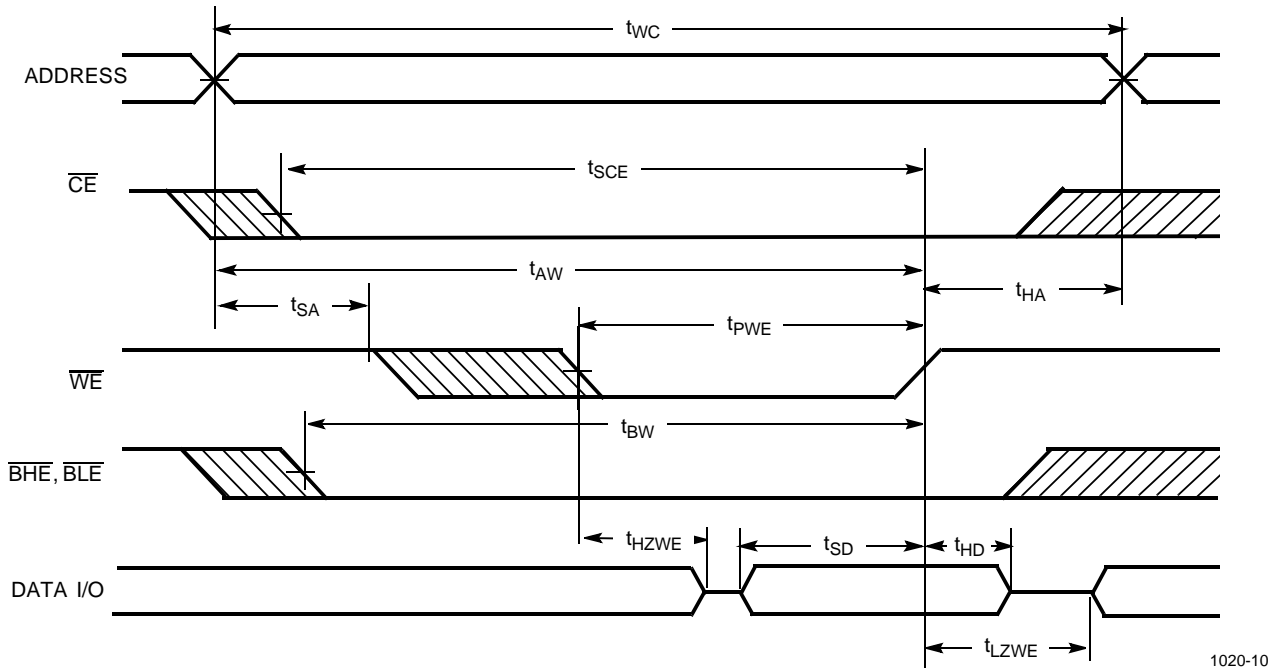
Switching Waveforms (continued)
Write Cycle No.3 (\overline{WE} Controlled, \overline{OE} LOW)

1020-10

Truth Table

\overline{CE}	\overline{OE}	\overline{WE}	\overline{BLE}	\overline{BHE}	I/O ₁ -I/O ₈	I/O ₉ -I/O ₁₆	Mode	Power
H	X	X	X	X	High Z	High Z	Power-Down	Standby (I_{SB})
L	L	H	L	L	Data Out	Data Out	Read - All bits	Active (I_{CC})
			L	H	Data Out	High Z	Read - Lower bits only	Active (I_{CC})
			H	L	High Z	Data Out	Read - Upper bits only	Active (I_{CC})
L	X	L	L	L	Data In	Data In	Write - All bits	Active (I_{CC})
			L	H	Data In	High Z	Write - Lower bits only	Active (I_{CC})
			H	L	High Z	Data In	Write - Upper bits only	Active (I_{CC})
L	H	H	X	X	High Z	High Z	Selected, Outputs Disabled	Active (I_{CC})
L	X	X	H	H	High Z	High Z	Selected, Outputs Disabled	Active (I_{CC})

Ordering Information

Speed (ns)	Ordering Code	Package Name	Package Type	Operating Range
10	CY7C1020-10VC	V34	44-Lead (400-Mil) Molded SOJ	Commercial
	CY7C1020L-10VC	V34	44-Lead (400-Mil) Molded SOJ	Commercial
	CY7C1020-10ZC	Z44	44-Lead TSOP Type II	Commercial
	CY7C1020L-10ZC	Z44	44-Lead TSOP Type II	Commercial
12	CY7C1020-12VC	V34	44-Lead (400-Mil) Molded SOJ	Commercial
	CY7C1020L-12VC	V34	44-Lead (400-Mil) Molded SOJ	Commercial
	CY7C1020-12ZC	Z44	44-Lead TSOP Type II	Commercial
	CY7C1020L-12ZC	Z44	44-Lead TSOP Type II	Commercial
15	CY7C1020-15VC	V34	44-Lead (400-Mil) Molded SOJ	Commercial
	CY7C1020L-15VC	V34	44-Lead (400-Mil) Molded SOJ	Commercial
	CY7C1020-15ZC	Z44	44-Lead TSOP Type II	Commercial
	CY7C1020L-15ZC	Z44	44-Lead TSOP Type II	Commercial
20	CY7C1020-20VC	V34	44-Lead (400-Mil) Molded SOJ	Commercial
	CY7C1020L-20VC	V34	44-Lead (400-Mil) Molded SOJ	Commercial
	CY7C1020-20ZC	Z44	44-Lead TSOP Type II	Commercial
	CY7C1020L-20ZC	Z44	44-Lead TSOP Type II	Commercial

Document #: 38-00542-C

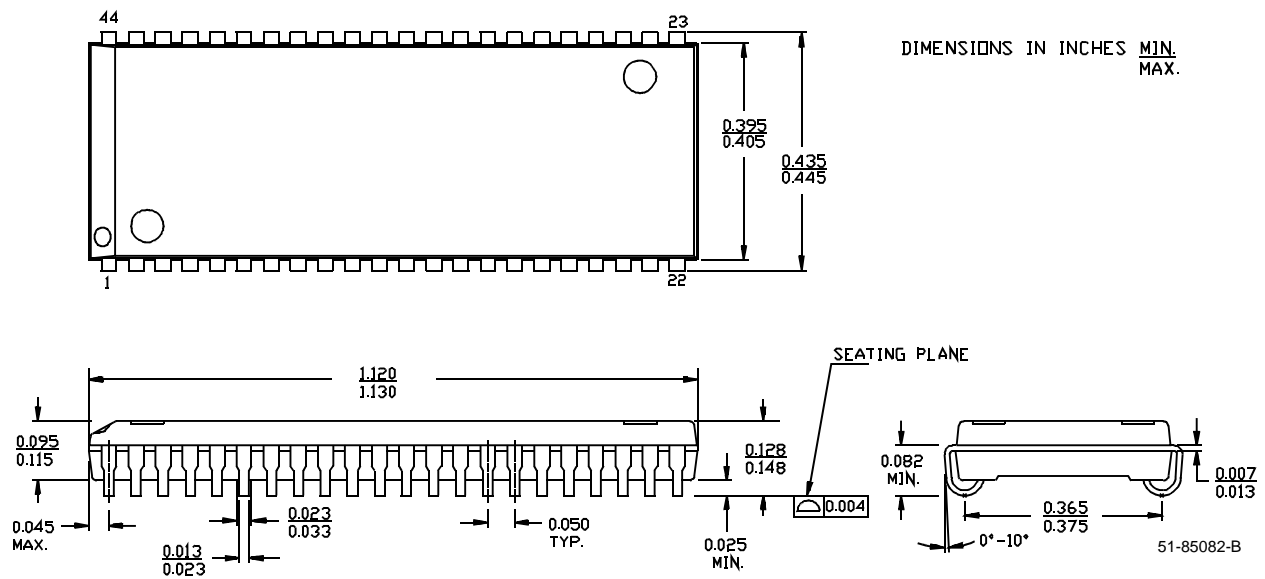
Package Diagrams
44-Lead (400-Mil) Molded SOJ V34

Package Diagrams (continued)
44-Pin TSOP II Z44

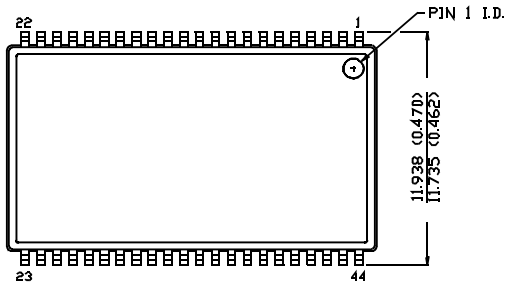
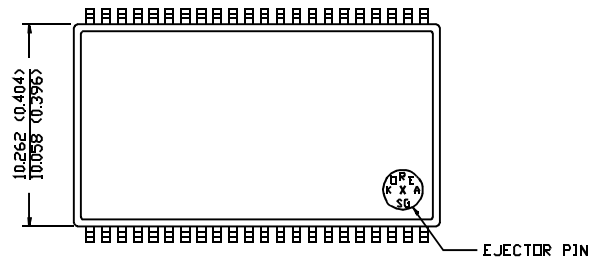
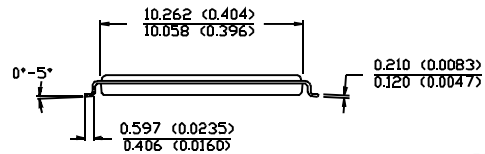
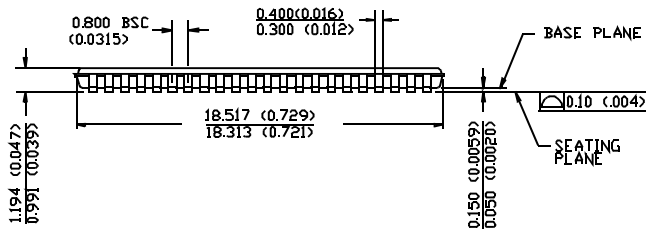
 DIMENSION IN MM (INCH)
 MAX
 MIN.

TOP VIEW

BOTTOM VIEW

51-85087-A