

### FEATURES

- User-Programmable Temperature Setpoint
- 2.0°C Setpoint Accuracy
- 4.0°C Preset Hysteresis
- Wide Supply Range (+2.7 V dc to +7.0 V dc)
- Wide Temperature Range (-40°C to +150°C)
- Low Power Dissipation (230  $\mu$ W @ 3.3 V)

### APPLICATIONS

- Industrial Process Control
- Thermal Control Systems
- CPU Monitoring (i.e., Pentium)
- Computer Thermal Management Circuits
- Fan Control
- Handheld/Portable Electronic Equipment

### FUNCTIONAL BLOCK DIAGRAM

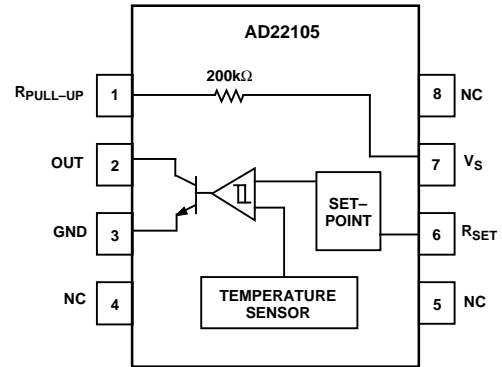

### GENERAL DESCRIPTION

The AD22105 is a solid state thermostatic switch. Requiring only one external programming resistor, the AD22105 can be set to switch accurately at any temperature in the wide operating range of -40°C to +150°C. Using a novel circuit architecture, the AD22105 asserts an open collector output when the ambient temperature exceeds the user-programmed setpoint temperature. The AD22105 has approximately 4°C of hysteresis which prevents rapid thermal on/off cycling.

The AD22105 is designed to operate on a single power supply voltage from +2.7 V to +7.0 V facilitating operation in battery powered applications as well as in industrial control systems. Because of low power dissipation (230  $\mu$ W @ 3.3 V), self-heating errors are minimized and battery life is maximized.

An optional internal 200 k $\Omega$  pull-up resistor is included to facilitate driving light loads such as CMOS inputs.

Alternatively, a low power LED indicator may be driven directly.

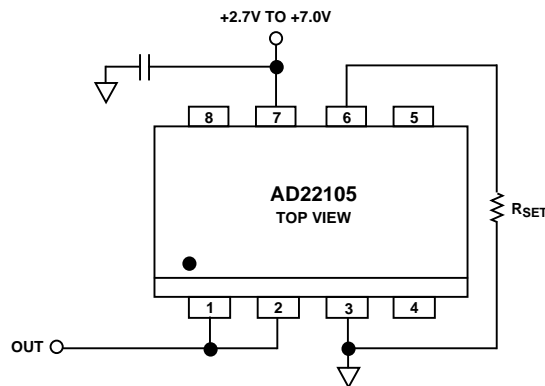

Figure 1. Typical Application Circuit

### REV. 0

Information furnished by Analog Devices is believed to be accurate and reliable. However, no responsibility is assumed by Analog Devices for its use, nor for any infringements of patents or other rights of third parties which may result from its use. No license is granted by implication or otherwise under any patent or patent rights of Analog Devices.

© Analog Devices, Inc., 1996

One Technology Way, P.O. Box 9106, Norwood, MA 02062-9106, U.S.A.  
Tel: 617/329-4700 Fax: 617/326-8703

# AD22105—SPECIFICATIONS (V<sub>S</sub> = 3.3 V, T<sub>A</sub> = +25°C, R<sub>LOAD</sub> = internal 200 kΩ, unless otherwise noted)

Parameter	Symbol	Conditions	Min	Typ	Max	Units
TEMPERATURE ACCURACY						
Ambient Setpoint Accuracy	ACC			±0.5	±2.0	°C
Temperature Setpoint Accuracy	ACC <sub>T</sub>	-40°C ≤ T <sub>A</sub> ≤ +125°C			±3.0	°C
Power Supply Rejection	PSR	+2.7 V <sup>1</sup> < V <sub>S</sub> < +7.0 V		±0.05	±0.15	°C/V
HYSTERESIS						
Hysteresis Value	HYS			4.1		°C
OPEN COLLECTOR OUTPUT						
Output Low Voltage	V <sub>OL</sub>	I <sub>SINK</sub> = 5 mA		250	400	mV
POWER SUPPLY						
Supply Range	V <sub>S</sub>		+2.7		+7.0	V
Supply Current, Output “LOW”	I <sub>S<sub>ON</sub></sub>				120	μA
Supply Current, Output “HIGH”	I <sub>S<sub>OFF</sub></sub>				90	μA
INTERNAL PULL-UP RESISTOR	R <sub>PULL-UP</sub>		140	200	260	kΩ
TURN-ON SETTling TIME	t <sub>ON</sub>			5		μs

## NOTES

<sup>1</sup>The AD22105 will operate at voltages as low as +2.2 V.

Specifications subject to change without notice.

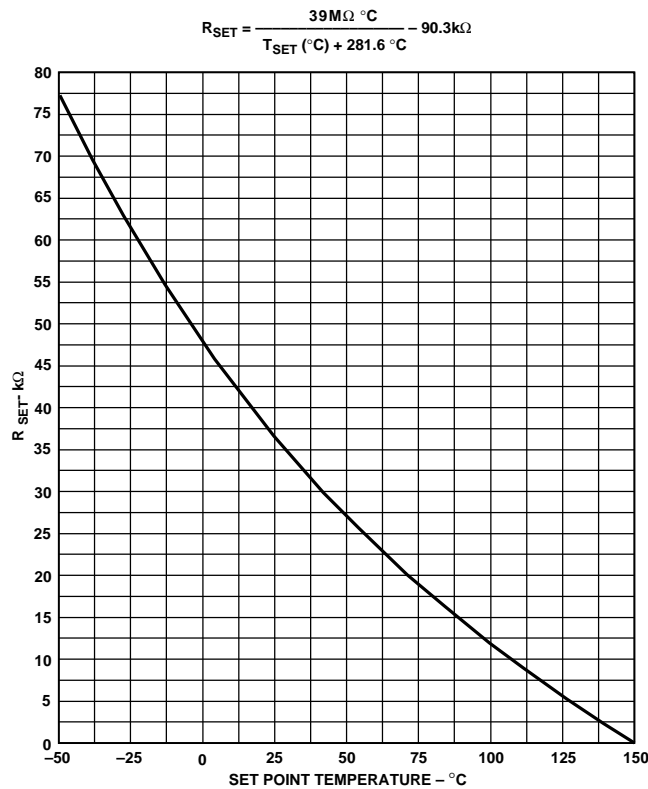

Figure 2. Setpoint Resistor Values

### ABSOLUTE MAXIMUM RATINGS\*

Maximum Supply Voltage	+11 V
Maximum Output Voltage (Pin 2)	+11 V
Maximum Output Current (Pin 2)	10 mA
Operating Temperature Range	-50°C to +150°C
Dice Junction Temperature	+160°C
Storage Temperature Range	-65°C to +160°C
Lead Temperature (Soldering, 10 sec)	+300°C

\*Stresses above those listed under “Absolute Maximum Ratings” may cause permanent damage to the device. This is a stress rating only and functional operation of the device at these or any other conditions above those listed in the operational sections of this specification is not implied. Exposure to absolute maximum rating conditions for extended periods may affect device reliability.

### ORDERING GUIDE

Model	Package Description	Package Option
AD22105AR	8-Lead SOIC	SO-8
AD22105AR-REEL7	8-Lead SOIC	SO-8

### PIN CONFIGURATION

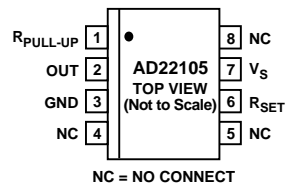

### PIN DESCRIPTION

Pin No.	Description
1	$R_{PULL-UP}$ , Internal 200 k $\Omega$ (Optional)
2	OUT
3	GND
4	No Connection
5	No Connection
6	$R_{SET}$ , Temperature Setpoint Resistor
7	$V_S$
8	No Connection

### CAUTION

ESD (electrostatic discharge) sensitive device. Electrostatic charges as high as 4000 V readily accumulate on the human body and test equipment and can discharge without detection. Although the AD22105 features proprietary ESD protection circuitry, permanent damage may occur on devices subjected to high energy electrostatic discharges. Therefore, proper ESD precautions are recommended to avoid performance degradation or loss of functionality.



# AD22105—Typical Performance Characteristics

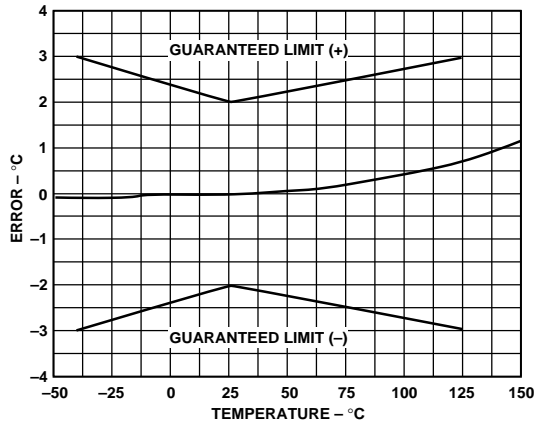

Figure 3. Error vs. Setpoint

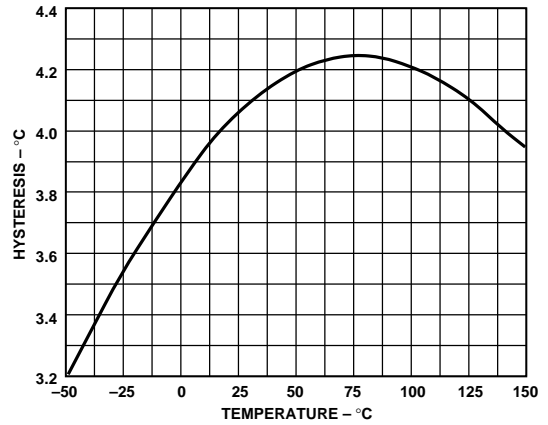

Figure 6. Hysteresis vs. Setpoint

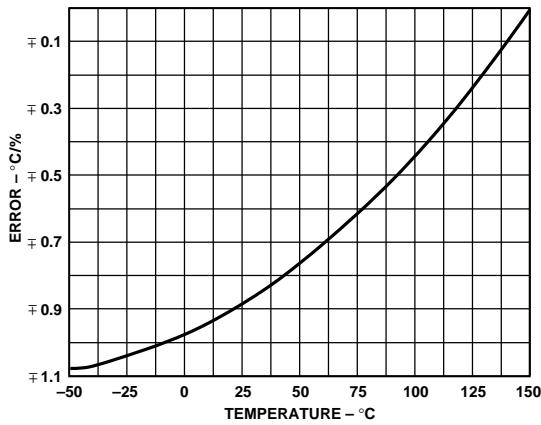

Figure 4. Setpoint Error Due to  $R_{SET}$  Tolerance

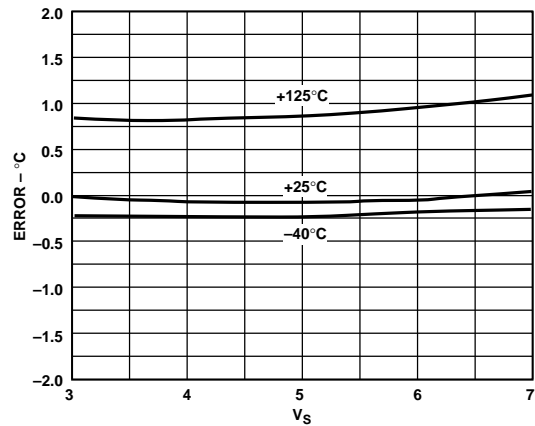

Figure 7. Setpoint Error vs. Supply Voltage

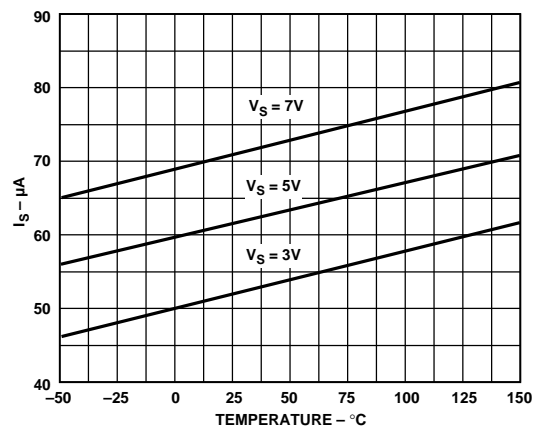

Figure 5. Supply Current vs. Temperature ( $V_{OUT} = HIGH$ )

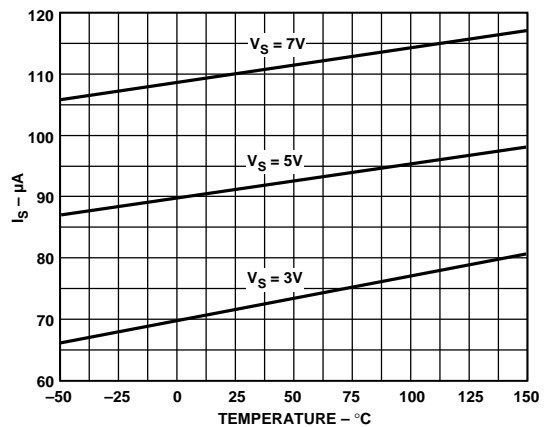

Figure 8. Supply Current vs. Temperature ( $V_{OUT} = LOW$ )

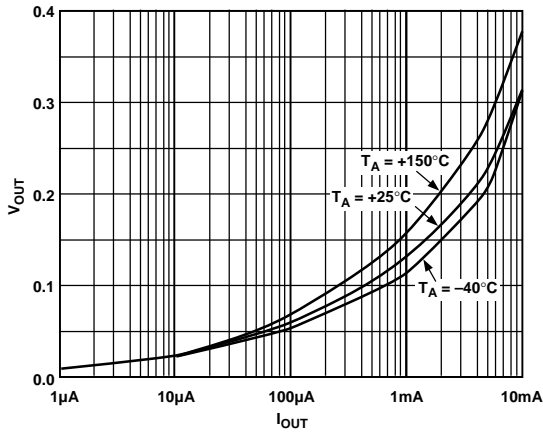

Figure 9.  $V_{OUT}$  vs.  $I_{OUT}$  ( $V_{OUT} = LOW$ )

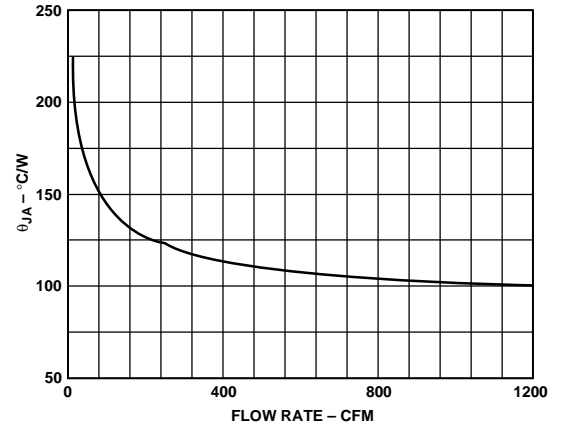

Figure 11. Thermal Resistance vs. Flow Rate

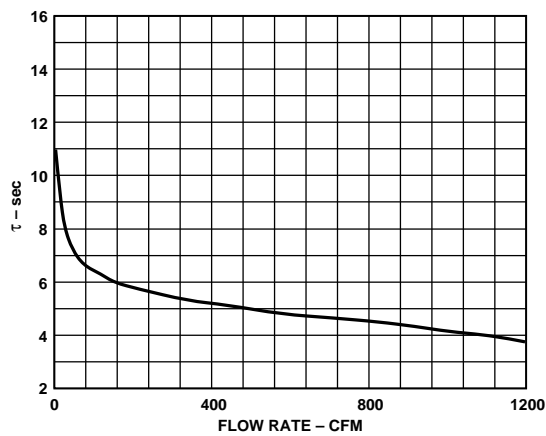

Figure 10. Thermal Response vs. Flow Rate

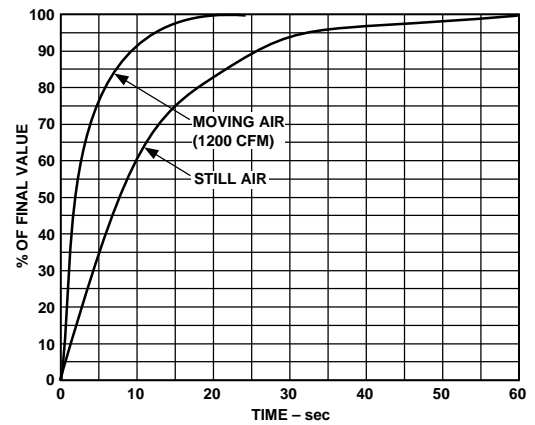

Figure 12. Thermal Response Time

# AD22105

## PRODUCT DESCRIPTION

The AD22105 is a single supply semiconductor thermostat switch that utilizes a unique circuit architecture to realize the combined functions of a temperature sensor, setpoint comparator, and output stage all in one integrated circuit. By using one external resistor, the AD22105 can be programmed to switch at any temperature selected by the system designer in the range of  $-40^{\circ}\text{C}$  to  $+150^{\circ}\text{C}$ . The internal comparator is designed to switch very accurately as the ambient temperature rises past the setpoint temperature. When the ambient temperature falls, the comparator relaxes its output at a somewhat lower temperature than that at which it originally switched. The difference between the “switch” and “unswitch” temperatures, known as the hysteresis, is designed to be nominally  $4^{\circ}\text{C}$ .

## THE SETPOINT RESISTOR

The setpoint resistor is determined by the equation:

$$R_{SET} = \frac{39 \text{ M}\Omega^{\circ}\text{C}}{T_{SET} (^{\circ}\text{C}) + 281.6^{\circ}\text{C}} - 90.3 \text{ k}\Omega \quad \text{Eq. 1}$$

The setpoint resistor should be connected directly between the  $R_{SET}$  pin (Pin 6) and the GND pin (Pin 3). If a ground plane is used, the resistor may be connected directly to this plane at the closest available point.

The setpoint resistor,  $R_{SET}$ , can be of nearly any resistor type, but its initial tolerance and thermal drift will affect the accuracy of the programmed switching temperature. For most applications, a 1% metal-film resistor will provide the best tradeoff between cost and accuracy. Calculations for computing an error budget can be found in the section “*Effect of Resistor Tolerance and Thermal Drift on Setpoint Accuracy.*”

Once  $R_{SET}$  has been calculated, it may be found that the calculated value does not agree with readily available standard resistors of the chosen tolerance. In order to achieve an  $R_{SET}$  value as close as possible to the calculated value, a compound resistor can be constructed by connecting two resistors in series or in parallel. To conserve cost, one moderately precise resistor and one lower precision resistor can be combined. If the moderately precise resistor provides most of the necessary resistance, the lower precision resistor can provide a fine adjustment. Consider an example where the closest standard 1% resistor has only 90% of the value required for  $R_{SET}$ . If a 5% series resistor is used for the remainder, then its tolerance only adds 5% of 10% or 0.5% additional error to the combination. Likewise, the 1% resistor only contributes 90% of 1% or 0.9% error to the combination. These two contributions are additive resulting in a total compound resistor tolerance of 1.4%.

## EFFECT OF RESISTOR TOLERANCE AND THERMAL DRIFT ON SETPOINT ACCURACY

Figure 3 shows the typical accuracy error in setpoint temperature as a function of the programmed setpoint temperature. This curve assumes an ideal resistor for  $R_{SET}$ . The graph of Figure 4 may be used to calculate *additional* setpoint error as a function of resistor tolerance. Note that this curve shows additional error beyond the initial accuracy error of the part and should be

added to the value found in the specifications table. For example, consider using the AD22105 programmed to switch at  $+125^{\circ}\text{C}$ . Figure 4 indicates that at  $+125^{\circ}\text{C}$ , the additional error is approximately  $-0.2^{\circ}\text{C}/\%$  of  $R_{SET}$ . If a 1% resistor (of exactly correct nominal value) is chosen, then the additional error could be  $-0.2^{\circ}\text{C}/\% \times 1\%$  or  $-0.2^{\circ}\text{C}$ . If the closest standard resistor value is 0.6% away from the calculated value, then the total error would be 0.6% for the nominal value and 1% for the tolerance or  $(1.006) \times (1.10)$  or 1.01606 (about 1.6%). This could lead to an additional setpoint error as high as  $0.32^{\circ}\text{C}$ .

For additional accuracy considerations, the thermal drift of the setpoint resistor can be taken into account. For example, consider that the drift of the metal film resistor is  $100 \text{ ppm}/^{\circ}\text{C}$ . Since this drift is usually referred to  $+25^{\circ}\text{C}$ , the setpoint resistor can be in error by an additional  $100 \text{ ppm}/^{\circ}\text{C} \times (125^{\circ}\text{C} - 25^{\circ}\text{C})$  or 1%. Using a setpoint temperature of  $125^{\circ}\text{C}$  as discussed above, this error source would add an additional  $-0.2^{\circ}\text{C}$  (for positive drift) making the overall setpoint error potentially  $-0.52^{\circ}\text{C}$  higher than the original accuracy error.

Initial tolerance and thermal drift effects of the setpoint resistor can be combined and calculated by using the following equation:

$$R_{MAX} = R_{NOM} \times (1 + \epsilon) \times (1 + T_C \times (T_{SET} - 25^{\circ}\text{C}))$$

where:

$R_{MAX}$  is the worst case value that the setpoint resistor can be at  $T_{SET}$ ,

$R_{NOM}$  is the standard resistor with a value closest to the desired  $R_{SET}$ ,

$\epsilon$  is the  $25^{\circ}\text{C}$  tolerance of the chosen resistor (usually 1%, 5%, or 10%),

$T_C$  is the temperature coefficient of the available resistor,

$T_{SET}$  is the desired setpoint temperature.

Once calculated,  $R_{MAX}$  may be compared to the desired  $R_{SET}$  from Equation 1. Continuing the example from above, the required value of  $R_{SET}$  at a  $T_{SET}$  of  $125^{\circ}\text{C}$  is  $5.566 \text{ k}\Omega$ . If the nearest standard resistor value is  $5.600 \text{ k}\Omega$ , then its worst case maximum value at  $125^{\circ}\text{C}$  could be  $5.713 \text{ k}\Omega$ . Again this is  $+2.6\%$  higher than  $R_{SET}$  leading to a total additional error of  $-0.52^{\circ}\text{C}$  beyond that given by the specifications table.

## THE HYSTERESIS AND SELF-HEATING

The actual value of the hysteresis generally has a minor dependence on the programmed setpoint temperature as shown in Figure 6. Furthermore, the hysteresis can be affected by self-heating if the device is driving a heavy load. For example, if the device is driving a load of  $5 \text{ mA}$  at an output voltage (given by Figure 9) of  $250 \text{ mV}$ , then the additional power dissipation would be approximately  $1.25 \text{ mW}$ . With a  $\theta_{JA}$  of  $190^{\circ}\text{C}/\text{W}$  in free air the internal die temperature could be  $0.24^{\circ}\text{C}$  higher than ambient leading to an increase of  $0.24^{\circ}\text{C}$  in hysteresis. In the presence of a heat sink or turbulent environment, the additional hysteresis will be less.

## OUTPUT SECTION

The output of the AD22105 is the collector of an NPN transistor. When the ambient temperature of the device exceeds the programmed setpoint temperature, this transistor is activated causing its collector to become a low impedance. A pull-up resistor, such as the internal 200 k $\Omega$  provided, is needed to observe a change in the output voltage. For versatility, the optional pull-up resistor has *not* been permanently connected to the output pin. Instead, this resistor is undedicated and connects from Pin 7 (V<sub>S</sub>) to Pin 1 (R<sub>PULL-UP</sub>). In order to use R<sub>PULL-UP</sub> a single connection should be made from Pin 1 (R<sub>PULL-UP</sub>) to Pin 2 (OUT).

The 200 k $\Omega$  pull-up resistor can drive CMOS loads since essentially no static current is required at these inputs. When driving “LS” and other bipolar family logic inputs a parallel resistor may be necessary to supply the 20  $\mu$ A–50  $\mu$ A I<sub>IH</sub> (High Level Input Current) specified for such devices. To determine the current required, the appropriate manufacturer’s data sheet should be consulted. When the output is *switched*, indicating an over temperature condition, the output is capable of pulling down with 10 mA at a voltage of about 375 mV. This allows for a fan out of 2 with standard bipolar logic and 20 with “LS” family logic.

Low power indicator LEDs (up to 10 mA) can be driven directly from the output pin of the AD22105. In most cases a small series resistor (usually of several hundred ohms) will be required to limit the current to the LED and the output transistor of the AD22105.

## MOUNTING CONSIDERATIONS

If the AD22105 is thermally attached and properly protected, it can be used in any measuring situation where the maximum range of temperatures encountered is between –40°C and +150°C. Because plastic IC packaging technology is employed, excessive mechanical stress must be avoided when fastening the device with a clamp or screw-on heat tab. Thermally conductive epoxy or glue is recommended for typical mounting conditions. In wet or corrosive environments, an electrically isolated metal or ceramic well should be used to protect the AD22105.

## THERMAL ENVIRONMENT EFFECTS

The thermal environment in which the AD22105 is used determines two performance traits: the effect of self-heating on accuracy and the response time of the sensor to rapid changes in temperature. In the first case, a rise in the IC junction temperature above the ambient temperature is a function of two variables: the power consumption of the AD22105 and the thermal resistance between the chip and the ambient environment,  $\theta_{JA}$ . Self-heating error can be derived by multiplying the power dissipation by  $\theta_{JA}$ . Because errors of this type can vary widely for surroundings with different heat sinking capacities, it is necessary to specify  $\theta_{JA}$  under several conditions. Table I shows how the magnitude of self-heating error varies relative to the environment. A typical part will dissipate about 230  $\mu$ W at room temperature with a 3.3 V supply and negligible output loading. In still air, without a “heat sink,” Table I indicates a  $\theta_{JA}$  of 190°C/W, which yields a temperature rise of 0.04°C. Thermal rise of the die will be considerably less in an environment of turbulent or constant moving air or if the device is in direct physical contact with a solid (or liquid) body.

Response of the AD22105 internal die temperature to abrupt changes in ambient temperatures can be modeled by a single time constant exponential function. Figure 11 shows typical response plots for moving and still air. The time constant,  $\tau$  (time to reach 63.2% of the final value), is dependent on  $\theta_{JA}$  and the thermal capacities of the chip and the package. Table I lists the effective  $\tau$  for moving and still air. Copper printed circuit board connections were neglected in the analysis; however, they will sink or conduct heat directly through the AD22105’s solder plated copper leads. When faster response is required, a thermally conductive grease or glue between the AD22105 and the surface temperature being measured should be used.

**Table I. Thermal Resistance (SO-8)**

Medium	$\theta_{JA}$ (°C/Watt)	$\tau$ (sec)*
Moving Air** Without Heat Sink	100	3.5
Still Air Without Heat Sink	190	15

### NOTES

\*The time constant is defined as the time to reach 63.2% of the final temperature change.

\*\*1200 CFM.

## USING THE AD22105 AS A COOLING SETPOINT DETECTOR

The AD22105 can be used to detect transitions from higher temperatures to lower temperatures by programming the setpoint temperature 4°C greater than the desired trip point temperature. The 4°C is necessary to compensate for the nominal hysteresis value designed into the device. A more precise value of the hysteresis can be obtained from Figure 6. In this mode, the logic state of the output will indicate a HIGH for under temperature conditions. The total device error will be slightly greater than the specification value due to uncertainty in hysteresis.

## APPLICATION HINTS

### EMI Suppression

Noisy environments may couple electromagnetic energy into the R<sub>SET</sub> node causing the AD22105 to falsely trip or untrip. Noise sources, which typically come from fast rising edges, can be coupled into the device capacitively. Furthermore, if the output signal is brought close to the R<sub>SET</sub> pin, energy can couple from the OUT pin to the R<sub>SET</sub> pin potentially causing oscillation. Stray capacitance can come from several places such as, IC sockets, multiconductor cables, and printed circuit board traces. In some cases, it can be corrected by constructing a Faraday shield around the R<sub>SET</sub> pin, for example, by using a shielded cable with the shield grounded. However, for best performance, cables should be avoided and the AD22105 should be soldered directly to a printed circuit board whenever possible. Figure 13 shows a sample printed circuit board layout with low inter-pin capacitance and Faraday shielding. If stray capacitance is unavoidable, and interference or oscillation occurs, a low impedance capacitor should be connected from the R<sub>SET</sub> pin to the GND pin. This capacitor must be considerably larger than the estimated stray capacitance. Typically several hundred picofarads will correct the problem.

# AD22105

## Leakage at the R<sub>SET</sub> Pin

Leakage currents at the R<sub>SET</sub> pin, such as those generated from a moist environment or printed circuit board contamination, can have an adverse effect on the programmed setpoint temperature of the AD22105. Depending on its source, leakage current can flow into or out of the R<sub>SET</sub> pin. Consequently, the actual setpoint temperature could be higher or lower than the intended setpoint temperature by about 1°C for each 75 nA of leakage.

With a 5 V power supply, an isolation resistance of 100 MΩ would create 50 nA of leakage current giving a setpoint temperature error of about 0.7°C (the R<sub>SET</sub> pin is near ground potential). A guard ring can be placed around the R<sub>SET</sub> node to protect against leakage from the power supply pin (as shown in Figure 13).

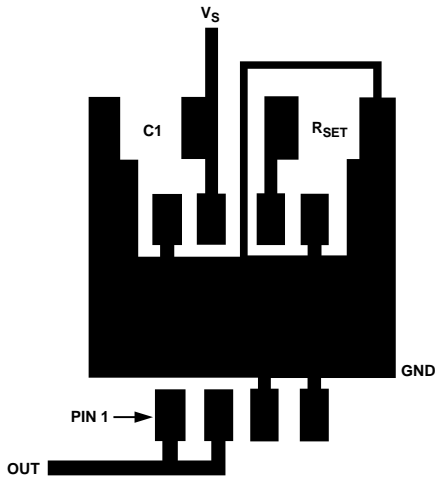

Figure 13. Suggested PCB Layout

## OUTLINE DIMENSIONS

Dimensions shown in inches and (mm).

### 8-Lead SOIC (SO-8)

